



KONICA MINOLTA

# **bizhub 226** USER'S GUIDE

✉ Fax







# Table of contents

## 1 Introduction

<b>1.1</b>	<b>Welcome .....</b>	<b>1-3</b>
1.1.1	User's guides .....	1-3
1.1.2	User's Guide .....	1-3
<b>1.2</b>	<b>Conventions used in this manual .....</b>	<b>1-4</b>
1.2.1	Symbols used in this manual .....	1-4
	To use this machine safely.....	1-4
	Procedural instruction.....	1-4
	Key symbols.....	1-5
1.2.2	Original and paper indications .....	1-5
	Original and paper sizes .....	1-5
	Original and paper indications .....	1-5

## 2 Before Using the Fax Function

<b>2.1</b>	<b>Control Panel.....</b>	<b>2-3</b>
2.1.1	Name and function of each part on Control Panel .....	2-3
2.1.2	Extended Operation Panel MK-749 (Optional).....	2-6
2.1.3	Display message.....	2-7
	List of pictograms in fax mode .....	2-8
2.1.4	Initial mode.....	2-8
<b>2.2</b>	<b>Original.....</b>	<b>2-9</b>
2.2.1	Using the ADF .....	2-9
2.2.2	Original types .....	2-9
2.2.3	Cautions on original .....	2-10
<b>2.3</b>	<b>First required registration and setting check.....</b>	<b>2-11</b>
2.3.1	Required registration.....	2-11
2.3.2	Checking the default settings .....	2-11
2.3.3	Specifying the current date and time.....	2-12
2.3.4	Specifying the time to switch to the daylight-saving time .....	2-13
2.3.5	Registering a local fax number .....	2-14
2.3.6	Registering a sender name .....	2-15
2.3.7	Specifying the line type.....	2-16
2.3.8	Specifying the line monitor sound .....	2-16
2.3.9	Specifying the communication line .....	2-17

## 3 How to Use the Fax Function

<b>3.1</b>	<b>Transmission procedure .....</b>	<b>3-3</b>
<b>3.2</b>	<b>Loading the original .....</b>	<b>3-5</b>
3.2.1	Loading the original into the ADF .....	3-5
3.2.2	Loading the original on the Original Glass .....	3-6
<b>3.3</b>	<b>Specifying the fax image quality.....</b>	<b>3-7</b>
3.3.1	Specifying the image quality .....	3-7
<b>3.4</b>	<b>Specifying a destination .....</b>	<b>3-8</b>
3.4.1	Specifying only one destination .....	3-8
3.4.2	Entering a fax number.....	3-8
3.4.3	One touch dial.....	3-9
3.4.4	Speed dial .....	3-10
3.4.5	Group dial .....	3-11
3.4.6	Program dial.....	3-12
3.4.7	Address Book (List, search) .....	3-13

3.4.8	Chain dial .....	3-14
3.4.9	Specifying multiple destinations (Sequential broadcast transmission).....	3-15
3.4.10	Manual redialing.....	3-16
<b>3.5</b>	<b>Operations during original scanning.....</b>	<b>3-17</b>
3.5.1	If memory has overflowed.....	3-17
	When [YES] is selected:.....	3-17
	When [NO] is selected:.....	3-17
<b>3.6</b>	<b>If a transmission fails.....</b>	<b>3-18</b>
<b>3.7</b>	<b>Sending a fax after calling (Manual transmission).....</b>	<b>3-19</b>
<b>3.8</b>	<b>Canceling a transmission.....</b>	<b>3-20</b>
3.8.1	Canceling a transmission.....	3-20
3.8.2	Canceling (deleting) a transmission reservation .....	3-20
<b>3.9</b>	<b>Checking the communication result (Report/List).....</b>	<b>3-21</b>
3.9.1	Checking the communication result .....	3-21
3.9.2	Printing out a report or list .....	3-21
<b>3.10</b>	<b>Report or List types .....</b>	<b>3-22</b>
	TX result report .....	3-22
	RX result report .....	3-22
	Activity report.....	3-22
	Memory image print.....	3-22
	One-touch dial list.....	3-23
	Speed dial list.....	3-23
	Key setting list.....	3-23
	Relay Box list .....	3-23
	Machine status list .....	3-23
	Configuration page .....	3-23
	PCL font list .....	3-23
<b>3.11</b>	<b>Memory Transmission and immediate transmission.....</b>	<b>3-24</b>
3.11.1	Memory transmission.....	3-24
3.11.2	Immediate transmission.....	3-24
<b>3.12</b>	<b>Specifying the transmission time (Specified-time transmission).....</b>	<b>3-25</b>
<b>3.13</b>	<b>Collectively sending multiple originals at the specified time (Batch transmission) .....</b>	<b>3-26</b>
<b>3.14</b>	<b>Receiving data.....</b>	<b>3-27</b>
3.14.1	Memory receiving.....	3-27
3.14.2	Paper size of received document .....	3-27
3.14.3	Paper priority sequence of received document.....	3-27
3.14.4	Automatically receiving data (Fax only mode) .....	3-27
3.14.5	Manually receiving data .....	3-28
<b>3.15</b>	<b>Making a call .....</b>	<b>3-29</b>
<b>3.16</b>	<b>Receiving a call .....</b>	<b>3-30</b>

## 4 Convenient Transmission and Receiving Functions

<b>4.1</b>	<b>Transmission with F-Code (F-Code TX).....</b>	<b>4-3</b>
4.1.1	Specifying an F code at fax transmission.....	4-3
4.1.2	Specifying an F code to register a destination .....	4-4
<b>4.2</b>	<b>Using a Confidential User Box for sending and receiving (Confidential communication) .....</b>	<b>4-5</b>
4.2.1	Registering a Confidential User Box.....	4-5
4.2.2	Sending data to a Confidential User Box (Confidential transmission).....	4-6
4.2.3	Printing out an original received by confidential reception.....	4-7
<b>4.3</b>	<b>Sending a document with a receiver's instruction (Polling TX).....</b>	<b>4-8</b>
4.3.1	Using Polling TX.....	4-8
4.3.2	Deleting a document sent by polling .....	4-9
<b>4.4</b>	<b>Receiving a sender's document with an instruction of this machine (Polling RX) .....</b>	<b>4-10</b>
<b>4.5</b>	<b>Specify a relay distribution station for transmission (Relay Instruction transmission).....</b>	<b>4-11</b>
<b>4.6</b>	<b>Specify this machine as a relay distribution station (Relay broadcasting).....</b>	<b>4-13</b>
<b>4.7</b>	<b>Forwarding a received document to the specified destination (Forward) .....</b>	<b>4-14</b>



## 5 Internet Fax

<b>5.1</b>	<b>Transmitting an Internet fax</b> .....	<b>5-3</b>
5.1.1	Transmitting an Internet fax .....	5-3
5.1.2	Basic transmission procedure .....	5-3
5.1.3	Using the Address Book for search (Address Search) .....	5-5
<b>5.2</b>	<b>Configuring transmission settings</b> .....	<b>5-7</b>
5.2.1	Specifying the transmission time .....	5-7
5.2.2	Selecting the Basic or Advanced mode.....	5-8
5.2.3	Specifying the maximum transmission size .....	5-8
5.2.4	Specifying the maximum transmission resolution .....	5-8
5.2.5	Specifying the compression coding method .....	5-9
<b>5.3</b>	<b>Specifying the image quality and density when scanning the original</b> .....	<b>5-10</b>
5.3.1	Specifying the image quality .....	5-10
5.3.2	Specifying the density .....	5-10
<b>5.4</b>	<b>Adding functions</b> .....	<b>5-11</b>
5.4.1	Specifying a title.....	5-11
5.4.2	Specifying a forward destination .....	5-11
5.4.3	Specifying header printing .....	5-12
<b>5.5</b>	<b>Receiving an Internet fax</b> .....	<b>5-13</b>
5.5.1	Receiving an Internet fax .....	5-13
5.5.2	Receivable data .....	5-13
5.5.3	Receiving an Internet fax automatically .....	5-14
5.5.4	Receiving an Internet fax manually .....	5-14

## 6 PC-FAX

<b>6.1</b>	<b>Overview of PC-Fax</b> .....	<b>6-3</b>
6.1.1	PC-FAX .....	6-3
6.1.2	Operating environment .....	6-4
6.1.3	Setup procedure .....	6-5
	USB connection.....	6-5
	Network connection.....	6-5
<b>6.2</b>	<b>Installing the fax driver</b> .....	<b>6-6</b>
6.2.1	Connection method and installation procedure.....	6-6
6.2.2	Uninstalling the fax driver .....	6-6
	Manual uninstallation .....	6-6
<b>6.3</b>	<b>Sending a fax</b> .....	<b>6-8</b>
6.3.1	Sending a fax .....	6-8
6.3.2	Creating a fax cover sheet .....	6-9
<b>6.4</b>	<b>Configuring fax driver settings</b> .....	<b>6-10</b>
6.4.1	Basic settings.....	6-10
6.4.2	Configuring sender information .....	6-11
6.4.3	Registering a destination in the address book .....	6-12
6.4.4	Editing a destination in the address book .....	6-12
6.4.5	Registering a group in the address book.....	6-13
6.4.6	Editing a group in the address book.....	6-13
6.4.7	Deleting a destination or group in the address book.....	6-13
6.4.8	Importing data to the address book .....	6-14
6.4.9	Exporting data from the address book .....	6-14

## 7 Utility and Fax Settings

<b>7.1</b>	<b>Utility settings</b> .....	<b>7-3</b>
<b>7.2</b>	<b>Store Address</b> .....	<b>7-6</b>
7.2.1	Registration items .....	7-6
7.2.2	Registering destinations in the one-touch dial .....	7-7

7.2.3	Changing or deleting a one-touch dial destination.....	7-8
7.2.4	Registering destinations in the speed dial.....	7-9
7.2.5	Changing or deleting a speed dial destination.....	7-10
7.2.6	Registering destinations in the group dial.....	7-11
7.2.7	Changing or deleting a Group dial destination.....	7-12
7.2.8	Registering destinations in the program dial.....	7-13
7.2.9	Changing or deleting the sequential broadcast transmission program.....	7-14
7.2.10	Changing or deleting the specified-time transmission program.....	7-14
7.2.11	Changing or deleting the confidential transmission program.....	7-15
7.2.12	Changing or deleting the polling RX program.....	7-15
7.2.13	Changing or deleting the relay instruction transmission program.....	7-16
<b>7.3</b>	<b>Fax registration.....</b>	<b>7-17</b>
7.3.1	Fax registration items.....	7-17
7.3.2	Registering the Confidential User Box.....	7-17
7.3.3	Deleting the Confidential User Box setting.....	7-18
7.3.4	Registering the Relay User Box.....	7-19
7.3.5	Deleting the Relay User Box setting.....	7-20
<b>7.4</b>	<b>Fax TX setting.....</b>	<b>7-21</b>
7.4.1	Fax TX setting items.....	7-21
7.4.2	Specifying the scanning density.....	7-21
7.4.3	Specifying the quality priority.....	7-22
7.4.4	Specifying the default TX mode.....	7-22
7.4.5	Configuring header printing.....	7-22
7.4.6	Configuring the fax number confirmation function.....	7-22
<b>7.5</b>	<b>Fax RX setting.....</b>	<b>7-23</b>
7.5.1	Fax RX setting items.....	7-23
7.5.2	Specifying the memory RX mode.....	7-24
7.5.3	Releasing the memory RX mode.....	7-24
7.5.4	Specifying the number of rings.....	7-25
7.5.5	Configuring the print reduction.....	7-25
7.5.6	Configuring the RX printing.....	7-25
7.5.7	Configuring the RX mode.....	7-26
7.5.8	Configuring the forward mode.....	7-26
7.5.9	Configuring footer printing.....	7-26
7.5.10	Selecting a tray.....	7-27
7.5.11	Configuring the closed network.....	7-27
<b>7.6</b>	<b>Report setting.....</b>	<b>7-28</b>
7.6.1	Report setting items.....	7-28
7.6.2	Selecting whether to automatically print out a Activity Report.....	7-28
7.6.3	Selecting whether to automatically print out a reservation report.....	7-28
7.6.4	Selecting whether to automatically print out a transmission result report.....	7-29
7.6.5	Selecting whether to automatically print out a receiving result report.....	7-29

## 8 PageScope Web Connection

<b>8.1</b>	<b>Overview.....</b>	<b>8-3</b>
8.1.1	Operating environments.....	8-3
<b>8.2</b>	<b>How to use PageScope Web Connection.....</b>	<b>8-4</b>
8.2.1	How to access.....	8-4
8.2.2	How to view the screen.....	8-4
8.2.3	User mode and administrator mode.....	8-5
8.2.4	How to operate.....	8-5
<b>8.3</b>	<b>User mode.....</b>	<b>8-6</b>
8.3.1	[System] - [Summary].....	8-6
8.3.2	[System] - [Details].....	8-6
8.3.3	[System] - [Maintenance] - [Counter].....	8-7



8.3.4	[System] - [Maintenance] - [Power Save Setting] .....	8-8
8.3.5	[System] - [Online Assistance] .....	8-8
8.3.6	[Print Job] - [Print Job Management] .....	8-9
8.3.7	[Print Job] - [File Download] .....	8-9
8.3.8	[Print] - [Settings] - [Paper Handling] .....	8-10
8.3.9	[Print] - [Settings] - [Page Layout] .....	8-10
8.3.10	[Print] - [Settings] - [Printer Setting] .....	8-11
8.3.11	[Print] - [Test Print] .....	8-12
8.3.12	[Print] - [Font Information] .....	8-12
8.3.13	[Address] - [One-Touch Dial Setting] .....	8-13
8.3.14	[Address] - [Speed Dial Setting] .....	8-13
8.3.15	[Address] - [Group Dial Setting] .....	8-14
8.3.16	[Network] - [Summary] .....	8-14

## 9 If This Message Appears

9.1	Primary messages and corrective actions .....	9-3
-----	---	-----

## 10 If you suspect a failure then do the following

10.1	Having problems sending a fax .....	10-3
10.2	Having problems receiving a fax .....	10-4
10.3	Having problems making a call .....	10-5

## 11 Others

11.1	Fax specifications .....	11-3
11.2	LSU .....	11-4
11.2.1	What is LSU? .....	11-4
11.2.2	LSU operating environment .....	11-4
11.2.3	Setup procedure .....	11-4
11.2.4	Installing LSU .....	11-5
11.2.5	Starting LSU .....	11-5
11.2.6	LSU screen .....	11-6
11.2.7	Connecting LSU to this machine .....	11-6
11.2.8	Downloading the registered information from this machine .....	11-6
11.2.9	Creating a new configuration file .....	11-7
11.2.10	Registering destinations in the one-touch dial .....	11-7
11.2.11	Editing a one-touch dial destination .....	11-7
11.2.12	Registering destinations in the speed dial .....	11-8
11.2.13	Editing a speed dial destination .....	11-8
11.2.14	Registering destinations in the group dial .....	11-9
11.2.15	Editing a destination in the group dial .....	11-9
11.2.16	Printing out the one-touch dial, speed dial, or group dial list .....	11-9
11.2.17	Saving settings in a computer .....	11-10
11.2.18	Saving settings on this machine .....	11-10
11.2.19	Saving the Utility settings .....	11-10
11.2.20	Configuring administrator settings .....	11-12
11.2.21	Viewing the total counter .....	11-13
11.2.22	Viewing the configuration page .....	11-13
11.2.23	Uninstalling LSU .....	11-13
11.3	Glossary .....	11-14

## 12 Index

12.1	Index by item .....	12-3
12.2	Index by button .....	12-6







# Introduction



# 1 Introduction

## 1.1 Welcome

Thank you for purchasing this machine.

This User's Guide describes the functions, operating instructions, precautions for correct operation, and simple troubleshooting guidelines of this machine. In order to obtain maximum performance from this product and use it effectively, please read this User's Guide as necessary.

### 1.1.1 User's guides

User's guide DVD manuals	Overview
[Quick Guide]	This manual describes operating procedures and the most frequently used functions to enable you to begin using this machine immediately. This manual describes details on trademarks and copyrights. <ul style="list-style-type: none"> <li>• Trademarks and copyrights</li> </ul>
[User's Guide Copy]	This manual describes details on copy mode operations and the settings of this machine. <ul style="list-style-type: none"> <li>• Specifications of originals and copy paper</li> <li>• Copy function</li> <li>• Maintaining this machine</li> <li>• Troubleshooting</li> </ul>
[User's Guide Fax]	This manual describes fax mode operations and settings. <ul style="list-style-type: none"> <li>• G3 fax function</li> <li>• Internet Fax</li> <li>• PC-FAX</li> </ul>
[User's Guide Print]	This manual describes details on printer functions. <ul style="list-style-type: none"> <li>• Printer function</li> <li>• Setting the printer driver</li> </ul>
[User's Guide Scan]	This manual describes details on scan functions. <ul style="list-style-type: none"> <li>• Scan Function</li> <li>• Setting the TWAIN/WIA scan driver</li> <li>• Network scan (E-mail TX, FTP TX, and SMB TX)</li> <li>• Scan to USB</li> </ul>
[User's Guide Network Administrator]	This manual describes details on setting methods for each function using the network connection. <ul style="list-style-type: none"> <li>• Network settings</li> <li>• Settings using <b>PageScope Web Connection</b></li> </ul>

### 1.1.2 User's Guide

This User's Guide is intended for users ranging from those using this machine for the first time to administrators.

It describes basic operations, functions that enable more convenient operations, maintenance procedures, simple troubleshooting operations, and various setting methods of this machine.

Note that basic technical knowledge about the product is required to enable users to perform maintenance work or troubleshooting operations. Limit your maintenance and troubleshooting operations to the areas explained in this manual.

Should you experience any problems, please contact our service representative.

## 1.2 Conventions used in this manual

### 1.2.1 Symbols used in this manual

Symbols are used in this manual to express various types of information.

The following describes each symbol related to correct and safe usage of this machine.

#### To use this machine safely

##### **WARNING**

- This symbol indicates that a failure to heed the instructions may lead to death or serious injury.

##### **CAUTION**

- This symbol indicates that negligence of the instructions may lead to mishandling that may cause injury or property damage.

##### **NOTICE**

*This symbol indicates a risk that may result in damage to this machine or documents. Follow the instructions to avoid property damage.*

##### Tips

- This symbol indicates supplemental information of a topic as well as options required to use a function.



##### **Reference**

*This symbol indicates reference functions related to a topic.*

#### Procedural instruction

- ✓ This check mark indicates an option that is required in order to use conditions or functions that are prerequisite for a procedure.

**1** This format number "1" represents the first step.

**2** This format number represents the order of serial steps.

- ➔ This symbol indicates a supplementary explanation of a procedural instruction.

The operation procedures are described using illustrations.

- ➔ This symbol indicates transition of the **Display** to access a desired menu item.

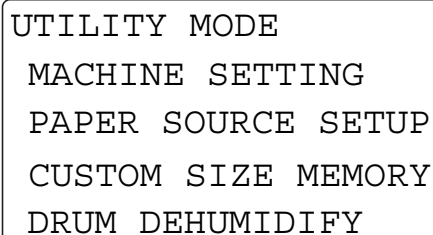

UTILITY MODE  
MACHINE SETTING  
PAPER SOURCE SETUP  
CUSTOM SIZE MEMORY  
DRUM DEHUMIDIFY

This symbol indicates a desired page.



### Reference

*This symbol indicates a reference.*

*View the reference as required.*

### Key symbols

[ ]

These brackets are used to indicate key names in the **Display** or computer screen, or a name of user's guide.

### Bold text

Key names, part names, product names and option names on the **Control Panel** are indicated in bold text.

## 1.2.2 Original and paper indications

### Original and paper sizes

The following explains the indication for originals and paper described in this manual.

When indicating the original or paper size, the Y side represents the width and the X side the length.

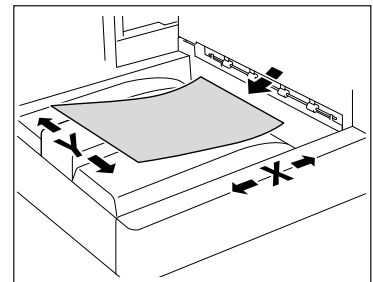

### Original and paper indications

☐ indicates the paper size with the length (X) being longer than the width (Y).

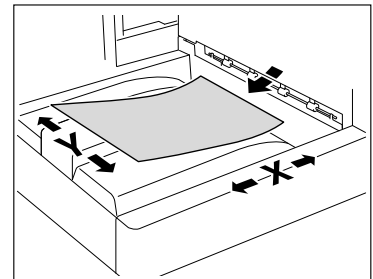

☐ indicates the paper size with the length (X) being shorter than the width (Y).

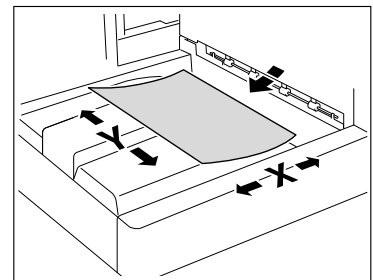



---

# **2** Before Using the Fax Function





## 2 Before Using the Fax Function

To use the fax function, optional **FAX Kit FK-510** and **Extended Operation Panel MK-749** are required.

### 2.1 Control Panel

#### 2.1.1 Name and function of each part on Control Panel

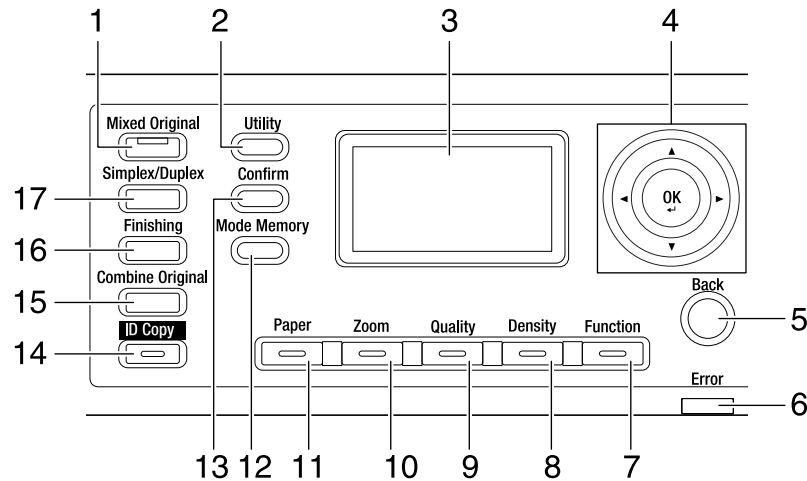

No.	Name	Functions	Page
1	<b>Mixed Original</b>	Press this key to select the mixed original mode.	-
2	<b>Utility</b>	Press this key to configure settings in the Utility screen. Machine setting, tray setting, custom size registration, user maintenance, administrator setting, copy setting 1, copy setting 2, destination registration, fax registration, fax transmission setting, fax receiving setting, report setting, scan setting	p. 7-3
3	<b>Display</b>	Displays the number of copies, zoom ratio, Utility screen, and error messages. This displays the image quality, density, and destination in the fax mode.	p. 2-7 p. 9-3
4	<b>▲, ▼, ◀, ▶ OK</b>	Use the ▲, ▼, ◀, and ▶ keys to move an selected item on the <b>Display</b> or change settings. Press the OK key to determine settings.	-
5	<b>Back</b>	Press this key to bring you back to the previous page.	-
6	<b>Error Indicator</b>	Lights or flashes in orange when an error occurs. For details, refer to [Quick Guide].	p. 9-3
7	<b>Function</b>	Press this key to configure the advanced copy settings such as copying with a binding position. For details, refer to [User's Guide Copy]. The fax mode offers convenient fax transfer settings such as a confidential transmission.	p. 4-6
8	<b>Density</b>	Press this key to select the density to scan a copy or fax original.	p. 5-10

No.	Name	Functions	Page
9	<b>Quality</b>	Select the image quality of the original. In the copy mode, select [TEXT], [PHOTO], or [TEXT/PHOTO]. For details, refer to [User's Guide Copy]. In the fax mode, select a combination of [TEXT] or [PHOTO] and [STD], [FINE], or [S-FINE].	p. 3-7 p. 5-10
10	<b>Zoom</b>	Press this key to enlarge or reduce an image in the copy mode. For details, refer to [User's Guide Copy].	-
11	<b>Paper</b>	Press this key to select a paper tray to be used.	-
12	<b>Mode Memory</b>	Press this key to register or recall the configured copy function. For details, refer to [User's Guide Copy].	-
13	<b>Confirm</b>	Press this key to confirm the counter or communication result, or print out a report.	p. 3-21
14	<b>ID Copy</b>	Press this key to copy the contents of the front and back sides of a card-size original such as a driver's license, onto one sheet. For details, refer to [User's Guide Copy].	-
15	<b>Combine Original</b>	Press this key to copy a multi-page original onto one sheet. For details, refer to [User's Guide Copy].	-
16	<b>Finishing</b>	Press this key to select the copy finishing mode from [NON-SORT], [SORT], or [GROUP]. For details, refer to [User's Guide Copy].	-
17	<b>Simplex/Duplex</b>	Press this key to use the automatic 2-sided printing function. This function is available when sending a 2-sided original in the fax mode.	-

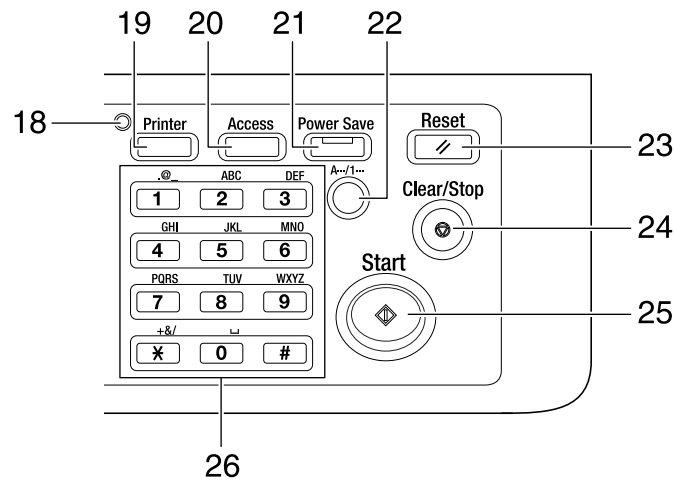

No.	Name	Functions	Page
18	<b>Printer Indicator</b>	Lights up green when the machine is in the printer mode.	-
19	<b>Printer</b>	Press this key to use the printer mode. For details, refer to [User's Guide Printer Operations].	-
20	<b>Access</b>	Press this key to use account track. For details, refer to [User's Guide Copy].	-
21	<b>Power Save</b>	Press this key to switch to the sleep mode.	-
22	<b>A...1...</b>	Press this key to toggle between the digit and text entry modes.	-
23	<b>Reset</b>	<ul style="list-style-type: none"> <li>Resets all settings you entered on the <b>Control Panel</b>. (Excluding the registered settings.)</li> <li>Erases the jobs you are currently configuring.</li> </ul>	-
24	<b>Clear/Stop</b>	<ul style="list-style-type: none"> <li>Clears a character or digit you are currently entering.</li> <li>Stops continuous copy operations.</li> <li>Stops fax transmission or receiving.</li> <li>Stops PC printing.</li> </ul>	-
25	<b>Start</b>	<ul style="list-style-type: none"> <li>Starts a copy operation.</li> <li>Pressing this key in the warm-up state starts the Next Copy Job function. For details, refer to [User's Guide Copy].</li> <li>Lights up blue when the machine is ready to accept a copy job, and lights up orange when the machine is not ready to start a copy operation.</li> <li>Starts a fax transmission.</li> </ul>	p. 3-3
26	<b>Keypad</b>	<ul style="list-style-type: none"> <li>Specify the number of copies.</li> <li>Enter various settings.</li> <li>Enter the fax number.</li> <li>Enter a one-touch number or characters.</li> <li>In the fax mode, the * key is used for tone sending (dialing telephone line), and the # key is used to access an outside line.</li> </ul>	-

### 2.1.2 Extended Operation Panel MK-749 (Optional)

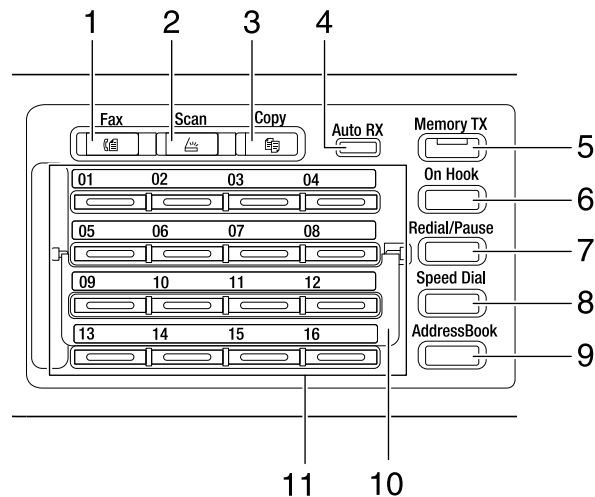

No.	Name	Functions	Page
1	<b>Fax</b>	Press this key to switch to the fax mode. The lamp lights up green when the machine is in the fax mode.	p. 3-3
2	<b>Scan</b>	Press this key to switch to the scan mode. The lamp lights up green when the machine is in the scan mode. (This function is available only when <b>Network Card NC-504</b> or <b>Image Controller IC-209</b> is installed.)	-
3	<b>Copy</b>	Press this key to switch to the copy mode. The lamp lights up green when the machine is in the copy mode.	-
4	<b>Auto RX Indicator</b>	Lights up green when the machine is set in the Auto RX mode.	p. 3-27
5	<b>Memory TX</b>	Press this key to configure a memory transmission. This lamp lights up green when the Memory TX mode is set to ON.	p. 3-24
6	<b>On Hook</b>	Press this key to set the machine in the state to take the phone off the hook. Repeating this key returns to the state to hang up.	p. 3-19
7	<b>Redial/Pause</b>	<ul style="list-style-type: none"> <li>Press this key to redial the recipient you called lastly.</li> <li>This function is available during the wait time to make a call from an extension line to an external line or accept an information service.</li> </ul>	p. 3-16
8	<b>Speed Dial</b>	Press this key to dial a fax number pre-registered in the speed dial.	p. 3-10
9	<b>AddressBook</b>	Press this key to display the information registered in the one-touch dial, group dial, and speed dial.	p. 3-13
10	<b>Switching Plate</b>	Use this plate to switch <b>One-touch Dial Key</b> numbers. When the <b>Switching Plate</b> is closed downward, one-touch dial keys 01 to 16 are available. When it is opened upward, one-touch dial keys 17 to 32 are available.	p. 3-9
11	<b>One-touch Dial Key</b>	<ul style="list-style-type: none"> <li>Press this key to dial a pre-registered destination.</li> <li>Use keys 01 to 32 to configure one-touch dial and group dial settings.</li> <li>Use keys 29 to 32 to configure program dial settings.</li> </ul>	p. 3-9

### 2.1.3 Display message

Fax mode screen

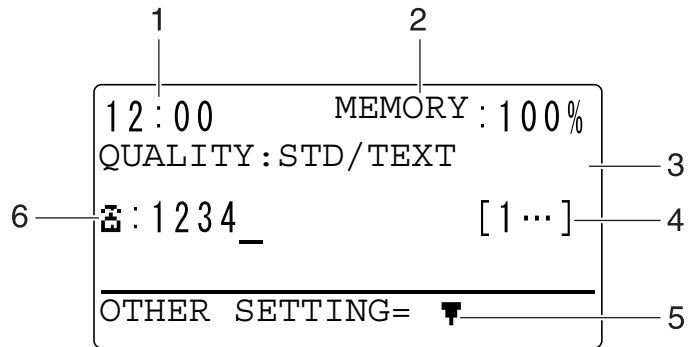



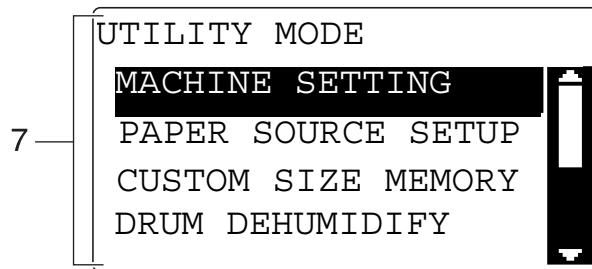







Utility screen



No.	Display message	Description
1	Time	Displays the current time that is set to this machine.
2	Remaining amount of memory	Displays the ratio of a free space in the memory. If the ratio comes close to 0%, a new original may not be scanned due to a memory shortage.
3	Image quality	Displays the image quality setting of the original.
	[STD/TEXT]	Indicates that [STD/TEXT] is selected.
	[FINE/TEXT]	Indicates that [FINE/TEXT] is selected.
	[S-FINE/TEXT]	Indicates that [S-FINE/TEXT] is selected.
	[STD/PHOTO]	Indicates that [STD/PHOTO] is selected.
	[FINE/PHOTO]	Indicates that [FINE/PHOTO] is selected.
	[S-FINE/PHOTO]	Indicates that [S-FINE/PHOTO] is selected.
4	Entry mode	Displays the currently specified entry mode.
	[1...]	Indicates that the digit entry mode is selected.
	[A...]	Indicates that the alphabet or symbol entry mode is selected.
5	Message	Displays a message to prompt you to go to [OTHER SETTING], or the state such as sending/receiving faxes or printing in the fax mode.
6	Fax number or E-mail address	Displays a fax number or E-mail address you are currently typing.
7	Mode or function	Displays setting menus or options.

## List of pictograms in fax mode

Pictogram		Description
	Dialing	Indicates that this machine is currently dialing.
	Incoming	Indicates that this machine is receiving an incoming call.
	Sending	Indicates that this machine is sending an original.
	Receiving	Indicates that this machine is receiving an original.
	Specified-time transmission standby state	Indicates that a specified-time transmission job is queued.
	Polling TX standby state	Indicates that a polling TX job is queued.
	Confidential RX standby state	Indicates that a confidential RX print job is queued.
	Memory RX	Indicates that there is a document which is currently received or has been received in the memory RX mode.
	In-memory proxy reception	Indicates that a document has been received by an in-memory proxy reception.
	2-sided original	Indicates that a 2-sided original is loaded on this machine.

### 2.1.4 Initial mode

When this machine is turned on or reset, it is placed into the initial mode. The initial mode is used as a basic mode to perform all operations.

#### Copy mode

- Number of copies: 1
- Copy density: Auto
- Zoom ratio: Full size (100%)
- Paper: Auto Paper
- Finishing: Non-sort

#### Fax mode

- Image quality: Text
- Density: Standard
- TX setting: Memory TX
- RX setting: Auto RX



#### Reference

*The initial mode can be changed in the Utility screen. For details on the initial mode settings, refer to page 7-3.*

## 2.2 Original

### 2.2.1 Using the ADF

The **ADF** is a device that scans multiple original pages while feeding out them one by one, and automatically outputs scanned pages. To realize the more efficient functions of this machine, use the appropriate original.

Using an inappropriate original would cause jamming and/or spoiling of the original or failure of the machine.

### 2.2.2 Original types

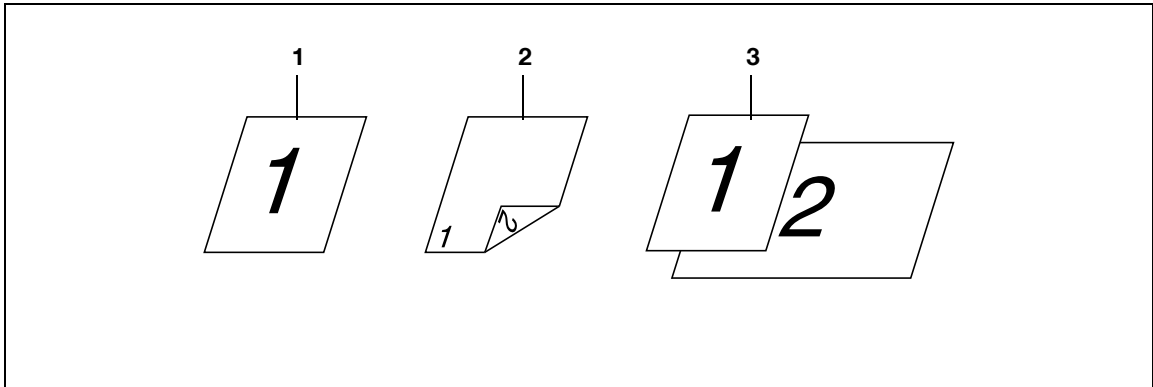

1. 1-sided original
2. 2-sided original
3. Mixed original

Original loading method	Original type	Original size
When using the <b>ADF</b> :	<ol style="list-style-type: none"> <li>1. 1-sided original (9-5/16 lb to 34-1/16 lb (35 g/m<sup>2</sup> to 128 g/m<sup>2</sup>))</li> <li>2. 2-sided original (13-5/16 lb to 34-1/16 lb (50 g/m<sup>2</sup> to 128 g/m<sup>2</sup>))</li> <li>3. Mixed original (13-5/16 lb to 34-1/16 lb (50 g/m<sup>2</sup> to 128 g/m<sup>2</sup>))</li> </ol>	11 × 17□ to 5-1/2 × 8-1/2□/□ (A3□ to A5□/□) Original width: 3-9/16 inches to 11-11/16 inches (90 mm to 297 mm) Original length: 8-1/2 inches to 17 inches (215.9 mm to 431.8 mm) In the mixed original mode, the following combinations are available. 11 × 17□ (A3□) and 8-1/2 × 11□ (A4□) 8-1/2 × 11□ (A4□) and 5-1/2 × 8-1/2□ (A5□) 8-1/2 × 14□ (B4□) and 5-1/2 × 8-1/2□ (B5□)
When using the <b>Original Glass</b> :	Highly translucent or transparent original, book original, three-dimensional objects Max. weight: 2 kg	11 × 17□ to 5-1/2 × 8-1/2□/□ (A3□ to A5□/□) Original width: Max. 11-11/16 inches (297 mm) Original length: Max. 17 inches (431.8 mm)

### 2.2.3 Cautions on original

The following types of originals should not be loaded into the **ADF**. If loaded, paper may be jammed or the original may be damaged.

- Wrinkled, folded, curled, or torn originals
- Highly translucent or transparent originals, such as OHP transparencies or diazo photosensitive paper
- Coated originals such as carbon-backed paper
- Original of which the basic weight is less than 35 g/m<sup>2</sup> or greater than 128 g/m<sup>2</sup>
- Originals that are bound, for example, with staples or paper clips
- Originals that are bound in a book or booklet form
- Originals with pages bound together with glue
- Originals with pages that have had cutouts removed or are cutouts
- Label sheets
- Offset printing masters
- Originals with binder holes
- Originals that have just been printed with this machine
- Photographic paper
- Glossy original such as gloss coating paper



## 2.3 First required registration and setting check

To efficiently use functions of this machine, pre-register the time and **One-Touch Dial Keys** explained in this section.

The report printing method and other settings are configured by factory defaults; however, they can be changed depending on usage situations. Check those settings before operating this machine.

### 2.3.1 Required registration

Before using this machine for the first time, be sure to register the following items.

- Current date and time
- Time to switch to daylight-saving time
- Local fax number
- Line type
- Line monitor sound
- Communication line (external or extension line)

Registering the following items allows you to effectively use this machine. We recommend that you register them.

- Sender (Your name or number)
- One-touch Dial
- Speed dial
- Program dial



#### Reference

*For details on how to enter a character string required for settings, refer to [User's Guide Copy].*

### 2.3.2 Checking the default settings

The settings of each function are pre-configured by factory defaults. Check the settings when you purchased this machine, and change them depending on usage situations.



#### Reference

*For details, refer to page 7-3.*

### 2.3.3 Specifying the current date and time

- 1 Press the **Utility** key.
- 2 Use **▲▼** to select [ADMIN. MANAGEMENT], and press the **OK** key.
- 3 Enter the administrator number using the **Keypad**, and press the **OK** key.  
→ The factory default of the administrator number is [000000].
- 4 Use **▲▼** to select [USER SETTING], and press the **OK** key.
- 5 Use **▲▼** to select [DATE&TIME], and press the **OK** key.
- 6 Enter the time and date using the **Keypad**, and press the **OK** key.  
→ Enter the time in a 24-hour system.  
→ For the year, type the last two digits of the year.
- 7 Use **▲▼** to select the time zone, and press the **OK** key.

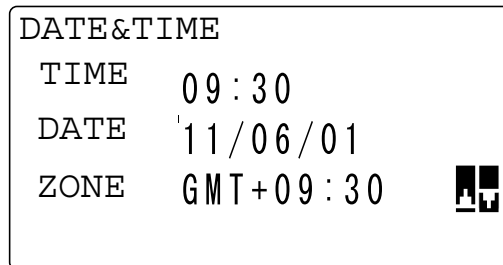

This returns to the User Settings screen.

### 2.3.4 Specifying the time to switch to the daylight-saving time

- 1 Press the **Utility** key.
- 2 Use **▲▼** to select [ADMIN. MANAGEMENT], and press the **OK** key.
- 3 Enter the administrator number using the **Keypad**, and press the **OK** key.  
→ The factory default of the administrator number is [000000].
- 4 Use **▲▼** to select [USER SETTING], and press the **OK** key.
- 5 Use **▲▼** to select [DAYLIGHT SAVING], and press the **OK** key.
- 6 Use **▲▼** to select [OFF] or [ON], and press the **OK** key.  
→ If [ON] is selected, enter the time difference (1 to 150 min.) in the following screen, and press the **OK** key.

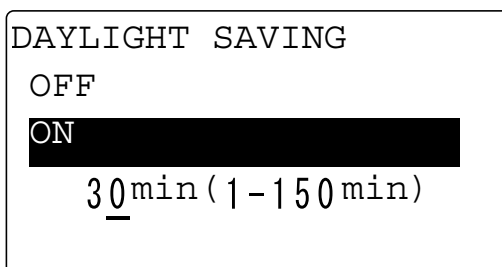

```
DAYLIGHT SAVING
OFF
ON
  30min (1-150min)
```

This returns to the User Settings screen.

#### Tips

- Use this setting to manually configure the difference between winter time and summer time. The time system does not automatically switch between winter time and summer time.

### 2.3.5 Registering a local fax number

- 1 Press the **Utility** key.
- 2 Use **▲▼** to select [ADMIN. MANAGEMENT], and press the **OK** key.
- 3 Enter the administrator number using the **Keypad**, and press the **OK** key.
- 4 Use **▲▼** to select [USER SETTING], and press the **OK** key.
- 5 Use **▲▼** to select [USER FAX NO.], and press the **OK** key.
- 6 Enter a fax number using the **Keypad**, and press the **OK** key.
  - For details on how to enter a character string, refer to [Quick Guide].
  - A fax number can be specified using up to 20 digits.
  - Available characters: Digits (0 to 9), space, +, -

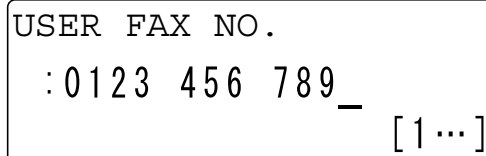

USER FAX NO.  
: 0 1 2 3 4 5 6 7 8 9 \_ [ 1 ... ]

This returns to the User Settings screen.

### 2.3.6 Registering a sender name

Register a sender name to be assigned to the header of the original to be sent.

Tips

- The sender name is printed at the leading edge of the sent original. When necessary, the original can be sent with no sender name added.

- 1 Press the **Utility** key.
- 2 Use ▲▼ to select [ADMIN. MANAGEMENT], and press the **OK** key.
- 3 Enter the administrator number using the **Keypad**, and press the **OK** key.
- 4 Use ▲▼ to select [USER SETTING], and press the **OK** key.
- 5 Use ▲▼ to select [USER NAME], and press the **OK** key.
- 6 Enter the sender name using the **Keypad**, and press the **OK** key.
  - For details on how to enter a character string, refer to [Quick Guide].
  - The sender name can be specified with up to 32 characters.

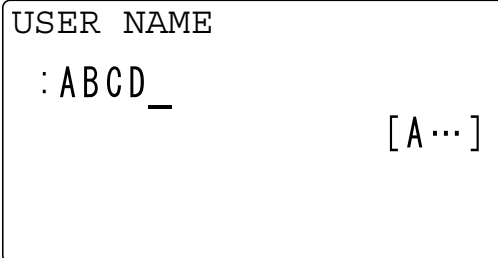

USER NAME  
: ABCD \_ [ A ... ]

This returns to the User Settings screen.

### 2.3.7 Specifying the line type

Telephone lines are classified into two types: Push telephone line (PB) and dialing telephone line. To realize a proper sending, match the type of your telephone line with the setting of this machine. Check the type of your telephone line, and specify the appropriate line type.

- 1 Press the **Utility** key.
- 2 Use **▲▼** to select [ADMIN. MANAGEMENT], and press the **OK** key.
- 3 Enter the administrator number using the **Keypad**, and press the **OK** key.
- 4 Use **▲▼** to select [COMM. SETTING], and press the **OK** key.
- 5 Use **▲▼** to select [TONE/PULSE], and press the **OK** key.
- 6 Use **▲▼** to select [TONE] or [PULSE], and press the **OK** key.

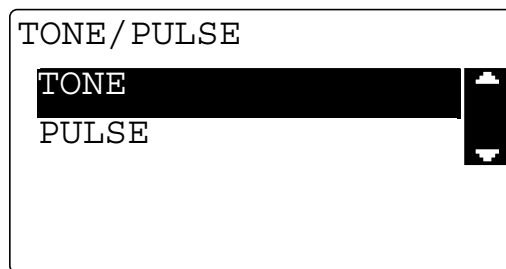

This returns to the Communication Settings screen.

### 2.3.8 Specifying the line monitor sound

Specify whether to hear the line sound from the speaker during communication.

- 1 Press the **Utility** key.
- 2 Use **▲▼** to select [ADMIN. MANAGEMENT], and press the **OK** key.
- 3 Enter the administrator number using the **Keypad**, and press the **OK** key.
- 4 Use **▲▼** to select [COMM. SETTING], and press the **OK** key.
- 5 Use **▲▼** to select [LINE MONITOR], and press the **OK** key.
- 6 Use **▲▼** to select the volume, and press the **OK** key.

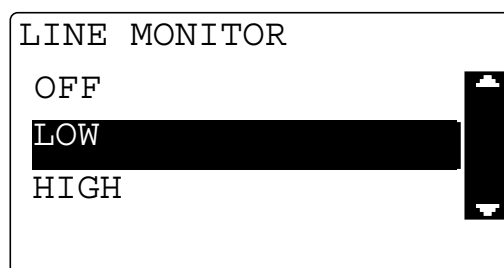

This returns to the Communication Settings screen.

### 2.3.9 Specifying the communication line

Specify whether [PSTN] (Public telephone line) or [PBX] (Private branch exchange) is connected as a communication line. When selecting [PBX], register the dial number for external or extension connection. A dial number for external or extension connection is registered in #.

- 1 Press the **Utility** key.
- 2 Use **▲▼** to select [ADMIN. MANAGEMENT], and press the **OK** key.
- 3 Enter the administrator number using the **Keypad**, and press the **OK** key.
- 4 Use **▲▼** to select [COMM. SETTING], and press the **OK** key.
- 5 Use **▲▼** to select [PSTN/PBX], and press the **OK** key.
- 6 Use **▲▼** to select [PSTN] or [PBX], and press the **OK** key.

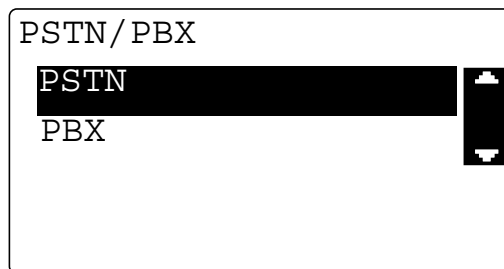

→ If [PBX] is selected, enter an external calling number in the following screen, and press the **OK** key.

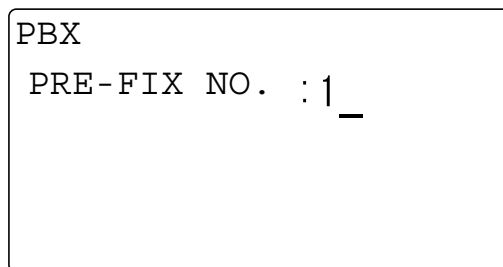

This returns to the Communication Settings screen.





---



## How to Use the Fax Function



## 3 How to Use the Fax Function

### 3.1 Transmission procedure

This section explains how to send a fax.

This machine supports the G3 fax function. Its sending and receiving are applicable only to G3-base remote machines.

- 1 Press the **Fax** key.  
This changes to the fax mode and displays the fax screen.
- 2 Load the original.  
→ For details on how to load the original, refer to page 3-5.

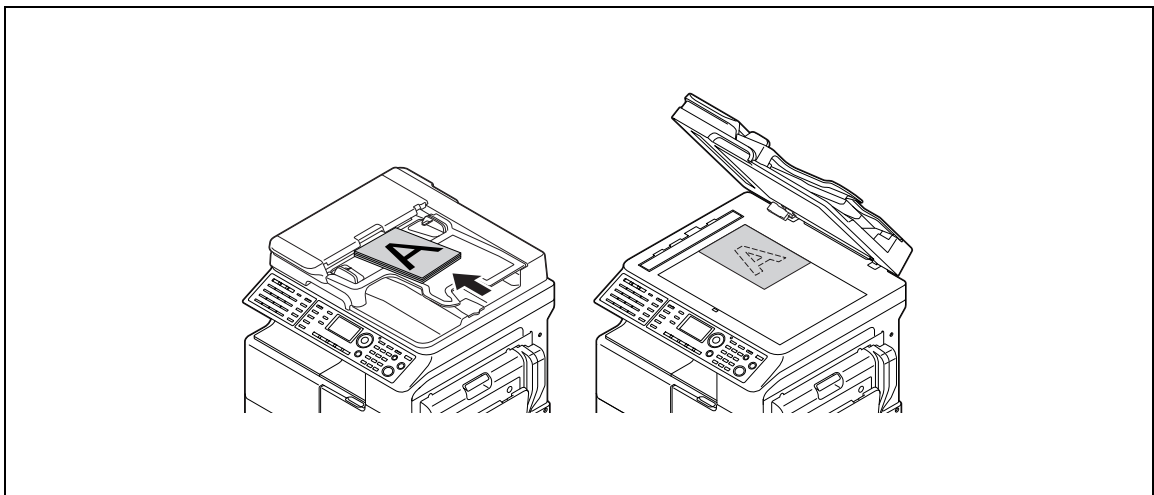

- 3 Specify a desired option for [QUALITY].  
→ For details on [QUALITY], refer to page 3-7.
- 4 Enter a destination fax number.  
→ For details on how to specify a destination, refer to page 3-8.

```

12:00      MEMORY : 100%
QUALITY : STD/TEXT
☎ : 1234_      [ 1... ]
-----
OTHER SETTING=  ▾
  
```

- 5 Press the **Start** key.  
→ This starts scanning and sending if the original has been loaded onto the **ADF**.  
After sending is completed, a "long beep" sounds.  
→ To stop sending, press the **Clear/Stop** key, and select [YES] in the displayed screen.  
→ If you load the original on the **Original Glass**, go to step 6.

- 6 Use ▲▼ to select [AUTO DETECTION] or [MANUAL], and press the **OK** key.  
→ If [MANUAL] is selected, specify the paper size.
- 7 To start scanning, press the **OK** key.  
→ When changing the scanning paper size, press ▼ to respecify the size.
- 8 When continuously scanning the original, load the next original, and press the **OK** key.  
→ Repeat this procedure until scanning of originals is completed.

12:00    MEMORY    : 100%  
QUALITY: STD/TEXT  
NEXT PAGE? (AUTO)    1  

---

SCAN=OK (TX=START)

- 9 When scanning of all originals has been completed, press the **Start** key.  
Sending starts.  
After sending is completed, a "long beep" sounds.  
→ To stop sending, press the **Clear/Stop** key, and select [YES] in the displayed screen.



#### Reference

*When necessary, you can cancel sending the scanned document. For details, refer to page 3-20.*

*If a transmission fails, a transmission result report is printed out. For details, refer to page 3-21.*

## 3.2 Loading the original

The original loading methods are classified into two types: loading the original into the **ADF** and loading the original on the **Original Glass**. Load the original in the appropriate method to fit the original type.

### 3.2.1 Loading the original into the ADF

- 1 Press the **Fax** key.

The machine switches to the fax mode.

- 2 Load the original into the **ADF**, turning up the side to be scanned.

- Up to 70 sheets can be loaded for A3-size plain paper.
- Do not load more than 70 sheets into the ADF at a time, and do not load the sheets up to the point where the top of the stack is higher than the ▼ mark. Doing so would cause the original to jam or become spoiled, or cause the machine to fail.
- If the original is 17 inches (432 mm) or more in length, only one sheet can be loaded.
- When scanning a 2-sided original, load it into the ADF, turning the first page up.

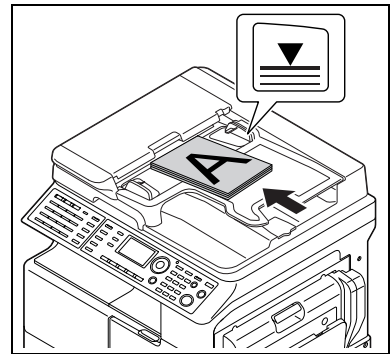

- 3 Adjust the **Lateral Guide** to the original size.

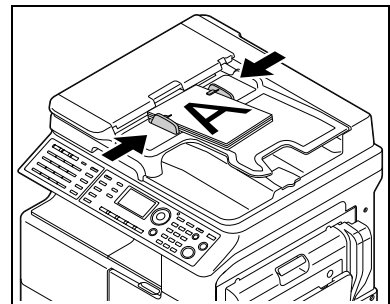

- A custom-size original can be scanned up to the sizes shown below.

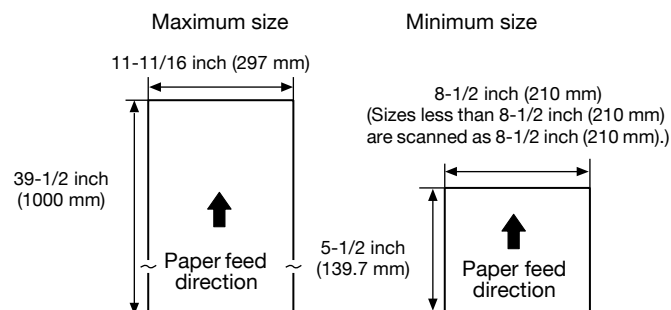

If the memory does not contain any received data, polling RX data, and other data, approximately 1,024 sheets (A4 standard original) can be scanned into the memory at one time.

## Tips

- The scanned original is sent with A4 width, B4 width, or A3 width, whichever is longer than and closest to the original.
- If the original is 39-1/2 inches (1,000 mm) or more in length, this machine judges that a original jam occurs, and stops scanning.
- The area 2 mm around the original image cannot be scanned.
- To scan the A3-width original in the Super Fine mode, up to 35-1/2 inches (900mm) are targeted for scanning.

### 3.2.2 Loading the original on the Original Glass

- 1 Press the **Fax** key.  
The machine switches to the fax mode.
- 2 Open the **ADF**, and load the original on the Original Glass, turning down the side to be scanned.  
→ Load the original along the **Original Scale** on the left and top sides of the platen.

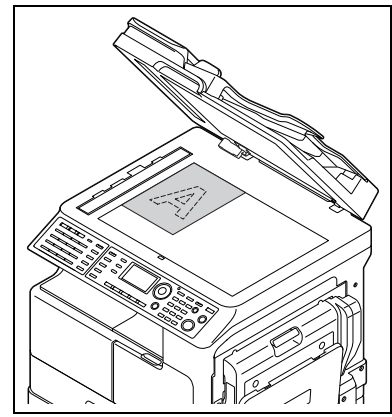

- 3 Close the **ADF**.

### 3.3 Specifying the fax image quality

There are various types of originals to be sent, for example, original in small print, original with accurate drawings, or original with photos. To send a clear original, specify the image quality to fit the original as shown below.

Contents of original	Image quality setting
Text original [TEXT], photo original [PHOTO]	[STD]/[FINE]/[S-FINE]

#### 3.3.1 Specifying the image quality

- 1 Press the **Fax** key.  
The machine switches to the fax mode.
- 2 Load the original.
- 3 Press the **Quality** key.
- 4 Use **▲▼** to select the fax image quality, and press the **OK** key.

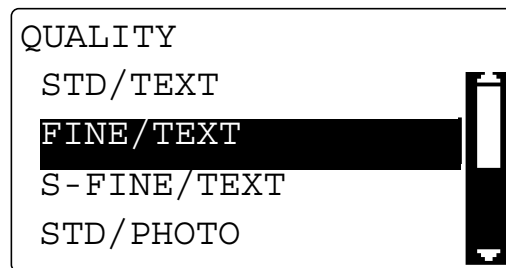

#### Tips

- If [S-FINE/TEXT] or [S-FINE/PHOTO] is selected, the original may not be sent as specified depending on destination models. In this case, the original is sent with [FINE/TEXT] or [STD/PHOTO].
- When [FINE/PHOTO] or [S-FINE/PHOTO] is specified, if the original size is larger than the paper of the destination side, the image quality may degrade depending on the performance of the destination fax machine.

## 3.4 Specifying a destination

### 3.4.1 Specifying only one destination

The following methods are provided to specify only one destination.

- Entering a dial number
- One-touch Dial
- Speed dial
- Group dial
- Program dial
- Address Book

This example shows a procedure to send a fax using the **ADF**.

### 3.4.2 Entering a fax number

- 1 Press the **Fax** key to change to the fax mode.
- 2 Load the original.
  - For details on how to load the original, refer to page 3-5.
- 3 When necessary, specify a desired option for [QUALITY].
  - For details on [QUALITY], refer to page 3-7.
- 4 Enter a destination fax number using the **Keypad**.
  - If the screen appears to prompt you to re-enter a fax number, type the same fax number again.
  - When necessary, you can configure a setting to enter a fax number twice, preventing a fax number entry error. For details, refer to page 7-22.

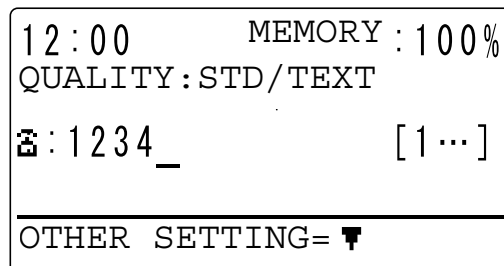

- A fax number can be specified with up to 30 digits.
  - Available characters: Digits (0 to 9), \*, #, space, and pause.
  - If you press the **Redial/Pause** key while entering a fax number, you can take a pause for approximately 3 seconds. [P] appears in the **Display** screen.
  - When a target outside line number is registered in the communication line settings while this machine is connected to a PBX communication line, you can type in [#] to recall the outside line number. For details on the communication line settings, refer to page 2-17.
  - When necessary, you can enter an F code such as SUB or SID. For details on the F code, refer to page 4-3.
- 5 Press the **Start** key.
    - This starts scanning and sending.



### 3.4.3 One touch dial

Register a destination number in a **One-Touch Dial Key** in advance; you can only press the **One-Touch Dial Key** to specify a target destination.



#### Reference

For details on how to register a destination in a one-touch dial key, refer to page 7-7

- 1 Load the original.
  - For details on how to load the original, refer to page 3-5.
- 2 When necessary, specify a desired option for [QUALITY].
  - For details on [QUALITY], refer to page 3-7.
- 3 Press a destination key among **One-Touch Dial Key 01 to 32**.
  - One-touch dial keys **01 to 16** are available when the **Switching Plate** is closed downward.

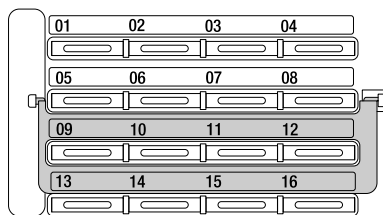

- One-touch dial keys **17 to 32** are available when the **Switching Plate** is opened upward.

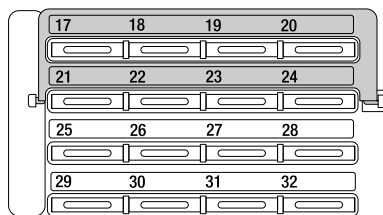

- If you press an incorrect **One-Touch Dial Key**, press the **Clear/Stop** key to cancel it.
- 4 Press the **Start** key.
    - This starts scanning and sending.
    - To stop sending, press the **Clear/Stop** key, and press **OK** in the displayed screen.

### 3.4.4 Speed dial

Register a destination number in Speed Dial in advance; you can specify a destination with a speed dial number to send a fax.



#### Reference

For details on how to register the speed dial, refer to page 7-9.

- 1 Load the original.
  - For details on how to load the original, refer to page 3-5.
- 2 When necessary, specify a desired option for [QUALITY].
  - For details on [QUALITY], refer to page 3-7.
- 3 Press the **Speed Dial** key.
- 4 Enter a 3-digit speed dial number using the **Keypad**, and press the **OK** key.

```
12:00    MEMORY    :100%
QUALITY:STD/TEXT
SPEED DIAL :011

-PRESS OK KEY-
```

→ If you make a mistake in entering a number, press the **Clear/Stop** and type in a correct number from the beginning.

- 5 Press the **Start** key.

This starts scanning and sending.

→ To stop sending, press the **Clear/Stop** key, and select [YES] in the displayed screen.

### 3.4.5 Group dial

Register a group in a **One-Touch Dial Key** in advance; you can only press the **One-Touch Dial Key** to send a fax to multiple destinations registered in the group.



#### Reference

For details on how to register a group in a **One-Touch Dial Key**, refer to page 7-11.

- 1 Load the original.
  - For details on how to load the original, refer to page 3-5.
- 2 When necessary, specify a desired option for [QUALITY].
  - For details on [QUALITY], refer to page 3-7.
- 3 Press a destination group key among **One-Touch Dial Keys 01 to 32**.
  - One-touch dial keys **01 to 16** are available when the **Switching Plate** is closed downward.
  - One-touch dial keys **17 to 32** are available when the **Switching Plate** is opened upward.
  - If you press an incorrect **One-Touch Dial Key**, press the **Clear/Stop** key to cancel it.
- 4 Press the **Start** key.

12:00 MEMORY: 100%  
QUALITY: STD/TEXT  
☎: NAGOYA  
-----  
OTHER SETTING = ▼

This starts scanning and sending.

- To stop sending, press the **Clear/Stop** key, and select [YES] in the displayed screen.

### 3.4.6 Program dial

Register a destination number and sending-receiving function such as the specified-time transmission or polling reception in a **One-Touch Dial Key** in advance; you can only press the **One-Touch Dial Key** to execute the function.



#### Reference

For details on how to register a destination in the program dial, refer to page 7-13.

- 1 Load the original.
  - For details on how to load the original, refer to page 3-5.
  - This step is not required for polling reception.
- 2 When necessary, specify a desired option for [QUALITY].
  - For details on [QUALITY], refer to page 3-7.
  - This step is not required for polling reception.
- 3 Press a key registered in the program dial among **One-Touch Dial Keys 29 to 32**.
  - One-touch dial keys **29 to 32** are available when the **Switching Plate** is opened upward.

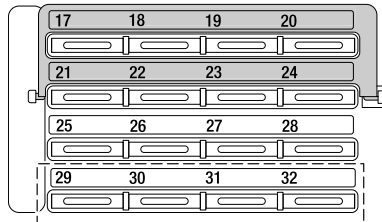

- If you press an incorrect **One-Touch Dial Key**, press the **Clear/Stop** key to cancel it.
- 4 Press the **Start** key.
    - The registered function starts automatically.
    - To stop sending, press the **Clear/Stop** key, and select [YES] in the displayed screen.



#### Reference

To cancel the specified-time transmission, press the **Function** key, and select [CANCEL RESERV.] to cancel the reservation. For details, refer to page 3-20.

### 3.4.7 Address Book (List, search)

Pressing **AddressBook** displays the contents registered in one-touch dials and speed dials. Search for a destination in the phone book to send a fax.

- 1 Load the original.
  - For details on how to load the original, refer to page 3-5.
- 2 When necessary, specify a desired option for [QUALITY].
  - For details on [QUALITY], refer to page 3-7.
- 3 Press **AddressBook**.
- 4 Use ▲▼ to select [LIST] or [SEARCH], and press the **OK** key.
  - Selecting [LIST]: Displays the contents registered in one-touch dial and speed dial. Use ▲▼ to select a destination, and press the **OK** key. Go to Step 7.
  - Selecting [SEARCH]: Displays the screen to enter an index. Go to Step 5.
  - If an optional **Image Controller IC-209** or **Network Card NC-504** is installed on this machine, [LDAP SEARCH] appears to enable Address Search. However, to use Address Search, configure LDAP settings in advance.  
For details on Address Search, refer to page 5-5. For details on LDAP settings, refer to [User's Guide Network Administrator].
- 5 Enter the first characters of a registered destination name using the **Keypad**, and press the **OK** key.
  - You can enter up to 10 characters.

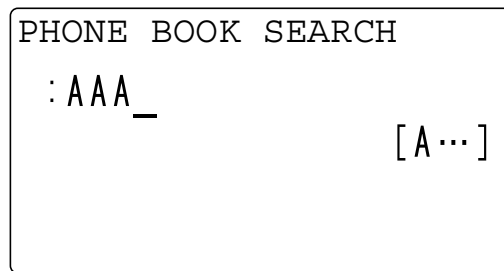

This displays registered names beginning with the entered character string.

- 6 Use ▲▼ to select a destination, and press the **OK** key.
- 7 Press the **Start** key.

This starts scanning and sending.

### 3.4.8 Chain dial

Specify a destination with a combination of the **One-Touch Dial Key**, speed dial, dial entry, and redial/pause functions to send a fax.

The following methods are provided to specify a destination.

- Entering a dial number
- One-touch Dial
- Speed dial
- Address Book

Tips

- To send a fax to multiple destinations, use the Memory TX function.

This example explains how to use a **One-Touch Dial Key** and enter a destination fax number.

- 1 Press the **On Hook** key.  
The Memory TX indicator lamp turns off, and [\*OFF HOOK\*] appears in the **Display** screen.
- 2 Press the **One-Touch Dial Key** of a destination, and press the **Start** key.
- 3 Enter a destination fax number using the **Keypad**, and load the original.  
→ For details on how to load the original, refer to page 3-5.

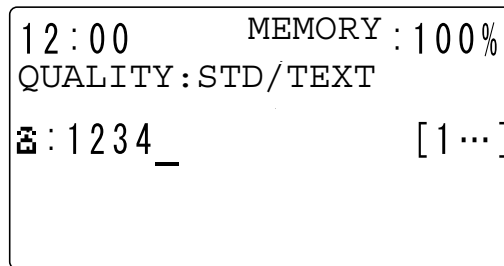

- 4 Press the **Start** key.  
The data is sent to the fax number specified with the **One-Touch Dial Key** and **Keypad**.  
To stop sending, press the **Clear/Stop** key, and press [YES] in the displayed screen.

### 3.4.9 Specifying multiple destinations (Sequential broadcast transmission)

The original can be sent to multiple destinations by one operation. This function is referred to as a sequential broadcast transmission.

The following methods are provided to specify multiple destinations.

- Entering a dial number
- One-touch Dial
- Speed dial
- Group dial
- Address Book

Tips

- To send a fax to multiple destinations, use the Memory TX function.
- Up to 255 destinations can be specified at one time. When using a **One-Touch Dial Key**, up to 32 destinations can be specified. When using Speed Dial, up to 250 destinations can be specified. When entering a fax number, up to 16 destinations can be specified.

When necessary, you can combine the methods above to specify destinations.

- 1 Load the original.  
→ For details on how to load the original, refer to page 3-5.
- 2 Press the **Function** key.
- 3 Use ▲▼ to select [BROADCAST], and press the **OK** key.
- 4 Specify a destination, and press the **OK** key.

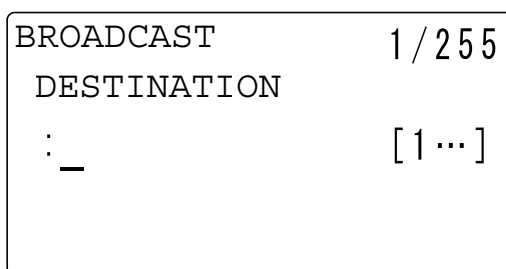

- When using a **One-Touch Dial Key**: Press the **One-Touch Dial Key** of a destination.
- When using Speed Dial: Press the **Speed Dial** key, and enter a 3-digit speed dial number of a destination.
- When using Group Dial: Press the **One-Touch Dial Key** assigned to a destination group.
- When using Address Book: Press **AddressBook** to select [LIST] or [SEARCH], and specify a destination. For details, refer to page 3-13.
- When entering a fax number: Enter a destination fax number.
- If an optional **Image Controller IC-209** or **Network Card NC-504** is installed on this machine, Address Search is available. For details, refer to page 5-5.

- 5 To add the destination, select [ADD], then press **OK**.  
→ Repeat Steps 4 and 5 to specify all destinations.
- 6 When necessary, specify a desired option for [QUALITY].  
→ For details on [QUALITY], refer to page 3-7.

- 7 Press the **Start** key.  
This starts scanning and sending.

Tips

- A result report is printed out after sending is completed; therefore, you can check whether a fax is sent to all destinations.
- To stop sending, press the **Clear/Stop** key, and select [YES] in the displayed screen. This cancels all the selected destinations.

- To cancel the specified-time transmission, press the Function key, and select [CANCEL RESERV.] to cancel the reservation. For details, refer to page 3-20.

### 3.4.10 Manual redialing

Redialing means dialing the last fax destination once more.

#### Tips

- Manual redialing is not available for group dialing.

- 1** Load the original.  
→ For details on how to load the original, refer to page 3-5.
- 2** When necessary, specify a desired option for [QUALITY].  
→ For details on [QUALITY], refer to page 3-7.
- 3** Press the **Redial/Pause** key.  
This displays a fax number of the destination the last fax was sent to.
- 4** Press the **Start** key.  
This starts scanning and sending.



## 3.5 Operations during original scanning

### 3.5.1 If memory has overflowed

If a memory shortage occurs during original scanning because of a specified-time transmission or transmission reservation, which is a function used to instruct a fax transmission during running of another fax transmission job, this machine displays a message asking the user to select whether to send up to the scanned original pages or cancel a transmission.

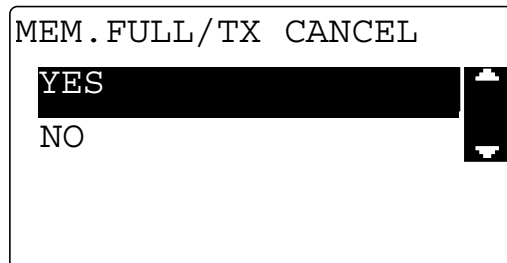

#### When [YES] is selected:

The data scanned until that point is erased. Wait for the end of another fax transmission job or fax reception job. After this, check the free space in the memory, and instruct a fax transmission again.

#### When [NO] is selected:

If the **Original Glass** is used, the machine sends the scanned original, and ends the operation. Check the free space in the memory, and issue a fax transmission instruction again.

If the **ADF** is used, the machine sends the scanned original pages, then scans and sends the pages remaining in the **Original Tray** again.

#### **NOTICE**

*If the memory level reaches 0%, the send data scanned until that point is erased.*

## 3.6 If a transmission fails

If a fax transmission ends abnormally because a destination fax machine returns no response in the busy state or a communication error occurs during fax transmission, this machine automatically redials the target destination. In this case, a document to be sent is handled as a reserved document that is queued for redialing.

As a result of redialing, if a fax transmission fails again, a transmission result report is printed out.

### Tips

- The default redialing count is 10 times, and the default redialing interval is 3 min. - 3 min. - 15 min. - 3 min. - 3 min., which is repeated twice. When necessary, these defaults can be changed. For details, contact your service representative.



### Reference

*For the transmission result report, refer to page 3-22.*

## 3.7 Sending a fax after calling (Manual transmission)

If this machine is connected to an external phone while a single line is shared between the phone and fax modes, you can send the original after talking on the phone with a recipient.

This function is available when notifying a recipient that an original has been sent.

### Tips

- Memory TX is not available when using the manual transmission.
- If a recipient is ready to automatically receive data (in the auto answer state), you will hear a "long beep" instead of a recipient's answer. In this case, you cannot speak to a recipient.
- When sending a fax after calling, use the **ADF**.
- The manual transmission is available when an external phone is connected to the TEL port of this machine.

- 1 Load the original onto the **ADF**.
  - For details on how to load the original, refer to page 3-5.
- 2 When necessary, specify a desired option for [QUALITY].
  - For details on [QUALITY], refer to page 3-7.
- 3 Pick up the phone receiver.
  - Check that you hear a dial tone "long beep" through the receiver.
  - When using a dialing telephone line, you can type in \* to output a signal for a push telephone line.

12:00            MEMORY : 100%  
 QUALITY : STD/TEXT  
 \*OFF HOOK\*

- 4 Specify a destination.
  - Use the dial buttons of the phone to dial a fax number.
  - You can also specify a destination using the **Control Panel** of this machine (p. 3-8).
- 5 After speaking, ask a recipient to press the Start key.
 

When the machine is ready, a "long beep" sounds.
- 6 Press the **Start** key.
 

This starts scanning and sending.
- 7 Put down the receiver.
  - To stop sending, press the **Clear/Stop** key, and select [YES] in the displayed screen.

### Tips

- Press the **On Hook** key instead of picking up the receiver; the speaker becomes active, and you can perform the manual transmission in the same way as for the above.

## 3.8 Canceling a transmission

### 3.8.1 Canceling a transmission

A transmission job can be canceled during processing.

- 1 Press the **Clear/Stop** key during transmission.
- 2 Use ▲▼ to select [YES], and press the **OK** key.

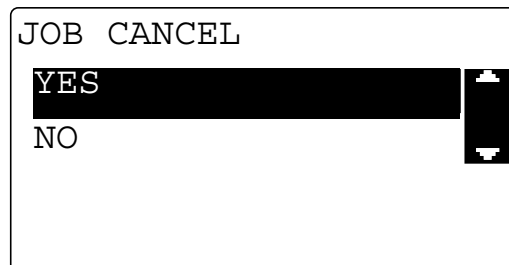

A transmission result report is printed out.

### 3.8.2 Canceling (deleting) a transmission reservation

When stopping a transmission job because the scanned document is queued for sending or redialing, delete the job, and cancel the transmission.

- 1 Press the **Function** key.
- 2 Use ▲▼ to select [CANCEL RESERV.], and press the **OK** key.  
This displays the details (specified transmission time, transmission setting type, and destination number) of transmission jobs queued in the memory.  
→ If polling TX jobs are queued, the ID entry screen appears. If no transmission jobs are queued in the memory, [\*NONE\*] appears.
- 3 Use ▲▼ to select a transmission job to be canceled, and press the **OK** key.

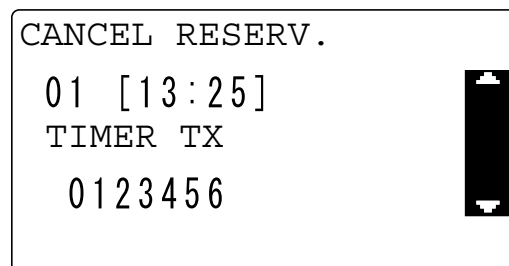

- 4 Select [YES] using ▲▼, and press **OK**.  
The selected transmission jobs are canceled (deleted).
- 5 To continuously delete reservations, repeat Steps 2 to 4.

## 3.9 Checking the communication result (Report/List)

After the original has been sent or received, its communication result information is recorded up to 60 items.

### 3.9.1 Checking the communication result

- 1 Press the **Confirm** key.
- 2 Use **▲▼** to select [TX/RX RESULT], and press the **OK** key.
- 3 Use **▲▼** to view the desired communication result.

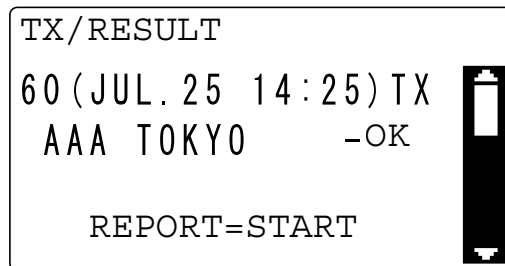

#### Tips

- The communication result screen displays [TX] as the transmission result and [RX] as the receiving result.
- If you press the **Back** key twice while viewing the communication result, the confirmation mode ends, and the basic screen appears.
- To print a communication result report, press the **Start** key. After a communication result report has been printed, the basic screen appears.

### 3.9.2 Printing out a report or list

- 1 Press the **Confirm** key.
- 2 Use **▲▼** to select [PRINT REPORT], and press the **OK** key.
- 3 Use **▲▼** to select a target report or list, and press the **OK** or **Start** key.

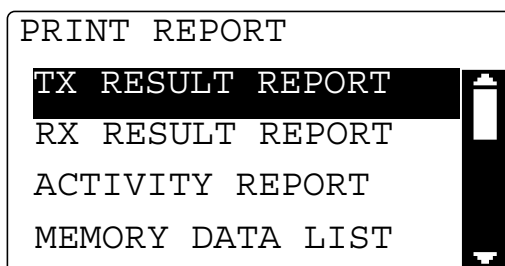

After the report or list has been printed, the basic screen appears.









#### Reference



A sending-receiving result report can be viewed on the **Display**. For details on how to display the communication result, refer to page 3-21.

For the report or list types, refer to page 3-22.

## 3.10 Report or List types

The following paper sizes are supported to print out a report.

8-1/2 x 5-1/2, 8-1/2 x 11, 8-1/2 x 14, 11 x 17, A5 , B5 , A4 , B4 , A3 

However, when using size 8-1/2 x 5-1/2, A5 , or B5 , a report may be printed in multiple sheets.

### TX result report

This report allows you to print out and check a document number, destination, transmission date, transmission starting time, number of original pages, duration, mode, communication result, and other items.

SESSION	FUNCTION	No.	DESTINATION STATION	DATE	TIME	PAGE	DURATION	MODE	RESULT
0001	TX	001	AAA NEWYORK 012345678	APR. 19	18:00	010	00h02 min21s	G3	OK

### RX result report

This report allows you to print out and check a document number, destination, receiving date, receiving start time, number of received original pages, duration, mode, communication result, and other items.

SESSION	FUNCTION	No.	DESTINATION STATION	DATE	TIME	PAGE	DURATION	MODE	RESULT
0001	BROADCAST	001	AAA TOKYO 098765432	APR. 19	18:00	001	00h02 min21s	ECM	NG
			00A0:ERROR DURING RX						

### Activity report

This report allows you to print out and check a number, document number, session date, sending-receiving start time, sending-receiving destination, number of sent or received original pages, mode, communication result, and other items.

By default, this report is automatically printed out every 60 sessions.

No.	SESSION	DATE	TIME	TX/RX	DESTINATION STATION	PAGE	DURATION	MODE	RESULT
01	0001	APR. 19	16:32	TX--	AAA NEWYORK 012345678	006	00h01 min16s	ECM	OK
02	0002	APR. 19	18:00	-- RX	AAA TOKYO 098765432	001	00h02 min21s	ECM	NG
03	0002	APR. 19	18:00	-- RX	AAA TOKYO 098765432	012	00h02 min48s	ECM	OK
04	0003	APR. 19	19:12	TX--	HEAD OF- FICE 024682468	001	00h00 min56s	ECM	OK

### Memory image print

This function allows you to print out and check a document number, names of queued functions, destination, date, time, number of original pages, and other items for each of the documents queued for sending in the memory, together with the miniature of the image in the first page.

### One-touch dial list

This list allows you to print out and check destinations registered in **One-Touch Dial Keys** in the order of the one-touch dial numbers.

OT-No.	DESTINATION STATION	DESTINATION NUMBER	DETAIL	SET DATE
OT-01	AAA NEWYORK	012345678	33.6	JAN.20.2001
OT-02	AAA TOKYO	098765432	14.4	JAN.20.2001
OT-03	HEAD OFFICE	024682468	16:00 33.6	FEB.12.2001
OT-04	NJ OFFICE	0P02345678 SUB:#1234	14.4	FEB.12.2001

### Speed dial list

This list allows you to print out and check destinations registered in Speed Dial in the order of speed dial numbers.

SP-No.	DESTINATION STATION	DESTINATION NUMBER	DETAIL	SET DATE
SP-001	AMSTERDAM OFFICE	0P09876543	33.6	JAN.20.2001
SP-002	KOREA OFFICE	0P01357913	14.4	JAN.20.2001
SP-003	ABCDEF	024682468	33.6	FEB.12.2001
SP-004	POST OFFICE	0224466880 SUB:#5678	14.4	FEB.12.2001

### Key setting list

This list allows you to print out and check the group dial numbers registered in **One-Touch Dial Key** and the program dial settings in the order of one-touch dial numbers.

### Relay Box list

This list allows you to print out and check the settings and details of 10 Relay User Boxes.

### Machine status list

This list allows you to print out and check the current machine settings.

### Configuration page

This report allows you to print out and check printer settings.

### PCL font list

This is enabled when optional **Image Controller IC-209** is installed.

The PCL font list can be printed out, enabling you to check the details.

## 3.11 Memory Transmission and immediate transmission

### 3.11.1 Memory transmission

The memory transmission function is enabled when the Memory TX indicator lamp of this machine is turned on.

Tips

- The factory default is [MEMORY TX].

The memory transmission function scans an original, saves it in the memory, and sends it by fax. Using this function, you can perform an operation to send the next original during communication. (Transmission reservation)



#### Reference

For details on how to use the memory transmission function, refer to page 3-3.

### 3.11.2 Immediate transmission

The immediate transmission function is enabled when the Memory TX indicator lamp of this machine is turned off.

Tips

- The default transmission mode is set to Memory TX. To change the normal transmission mode to the immediate transmission mode, set [DEFAULT TX] to [ADF TX] in the Utility screen. For details, refer to page 7-22.

The immediate transmission function can scan the original on a page basis depending on transmission conditions. This function securely sends a large amount of original.

Tips

- When specifying the immediate transmission, use the **ADF**. The immediate transmission is not available when using the **Original Glass**.
- If the immediate transmission is specified during sending or receiving, it is handled as a transmission reservation.
- The immediate transmission does not support a function that sends data to multiple destinations.
- The immediate transmission cannot be specified together with the specified-time transmission.

- 1** Load the original onto the **ADF**.  
→ For details on how to load the original, refer to page 3-5.
- 2** Press the **Memory TX** key.  
The Memory TX indicator lamp turns off.
- 3** When necessary, specify a desired option for [QUALITY].  
→ For details on [QUALITY], refer to page 3-7.

**4** Specify a destination.

**5** Press the **Start** key.

This starts scanning and sending.

Tips

- After transmission has been ended, the transmission mode returns to the default.



## 3.12 Specifying the transmission time (Specified-time transmission)

The function that specifies a communication time is referred to as a specified-time transmission. Costs can be cut by transmitting faxes in the late evening or early morning when discount telephone services are available.

### Tips

- Enter the time using the 24-hour system.
- If the current time is not registered accurately, data cannot be sent at the specified time. For details on how to specify the current time, refer to page 2-12.
- The specified-time transmission can be specified with the sequential broadcast transmission, confidential transmission, polling reception, and relay instruction transmission.
- The specified-time transmission cannot be used together with the immediate transmission.

- 1 Load the original.
- 2 When necessary, specify a desired option for [QUALITY].
- 3 Specify a destination.  
→ For details on how to specify a destination, refer to page 3-8.
- 4 Press ▼.  
The other setting screen appears.
- 5 Use ▲▼ to select [TIMER SETTING], and press the **OK** key.
- 6 Enter the transmission time using the **Keypad**, and press the **OK** key.

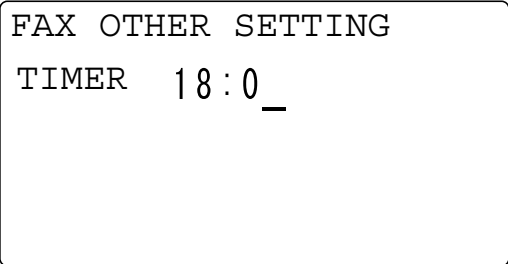

```
FAX OTHER SETTING
TIMER  18:0_
```

- 7 Use ▲▼ to select [RETURN], and press the **OK** key.  
This returns to the transmission screen.
- 8 Press the **Start** key.  
This starts scanning, and changes to the transmission standby state.



### Reference

*A transmission reservation can be canceled. For details, refer to page 3-20.*

### 3.13 Collectively sending multiple originals at the specified time (Batch transmission)

The batch transmission function collectively sends multiple originals stored in the memory at the specified time. In advance, register the batch transmission setting (transmission time) in a **One-Touch Dial Key** in the Utility screen.



#### Reference

*For details on how to register the batch transmission setting in a **One-Touch Dial Key**, refer to page 7-7.*

- 1 Load the original.  
→ For details on how to load the original, refer to page 3-5.
- 2 When necessary, specify a desired option for [QUALITY].  
→ For details on [QUALITY], refer to page 3-7.
- 3 Press a **One-Touch Dial Key** in which the batch transmission setting is registered.
- 4 Press the **Start** key.

This automatically starts scanning, and sends data at the specified time.

#### Tips

- To cancel a reservation of the batch transmission, press the **Function** key, and select [CANCEL RE-SERV.] to cancel the reservation for each transmission job. For details, refer to page 3-20.

## 3.14 Receiving data

### 3.14.1 Memory receiving

This machine ordinarily prints out data automatically when a fax is received. However, if you have received a confidential document, you can save it in the memory once, and print it out at the specified time or when the [MEMORY RX MODE] is set to [OFF].









#### Reference

To enable or disable Memory RX, use the Utility screen. For details on the setting procedure, refer to page 7-24.

### 3.14.2 Paper size of received document

This machine prints out the received document on the following type of paper.

8-1/2 x 5-1/2, 8-1/2 x 11, 8-1/2 x 14, 11 x 17, A5 , B5 , A4 / , B4 , A3 

### 3.14.3 Paper priority sequence of received document

If any tray does not contain paper that is the same size as the received original, this machine prints out the original on the appropriate paper in the following priority sequence.

- 1 The original is printed on paper of which the width matches that of the received original, covering the original length.
- 2 If the width of the received original matches that of paper, which does not cover the original length, the original is printed out separately.
- 3 If the width of the received original does not match that of paper, the original is printed out on paper of which the width is one size larger than the original, covering the original length.
- 4 When the width of paper does not match that of the received original, if the original length cannot be covered even using paper of the one-size larger width, the original is printed out separately.

#### Tips

- When [CUT] is selected in the [REDUCTION RX] setting of [FAX RX OPERATION], if the length of the original is longer than the length of the paper, it is cut by up to 1 inch (24 mm). However, if the length of the original is longer than the length of the paper by 1 inch (24 mm) or more, the original is printed separately instead of using [CUT]. For details, refer to page 7-25.

### 3.14.4 Automatically receiving data (Fax only mode)

This mode is available when using the telephone line only in the fax mode.

The machine automatically starts receiving fax data when it detects call signals by the number of times specified in the call count.



#### Reference

The factory default is set to this mode. For details, refer to page 7-26.

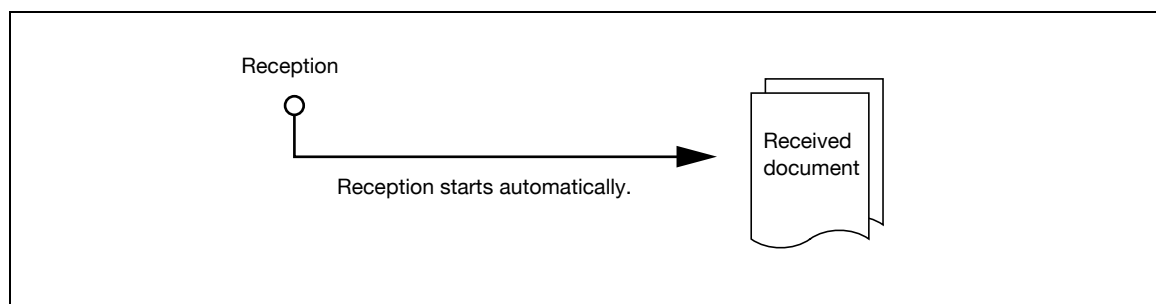

### 3.14.5 Manually receiving data

This mode is useful when this machine is connected to an external phone and a single line is shared between the phone and fax modes where it is used mainly in the phone mode. This mode allows you to receive a fax document without hanging up after speaking with the sender.

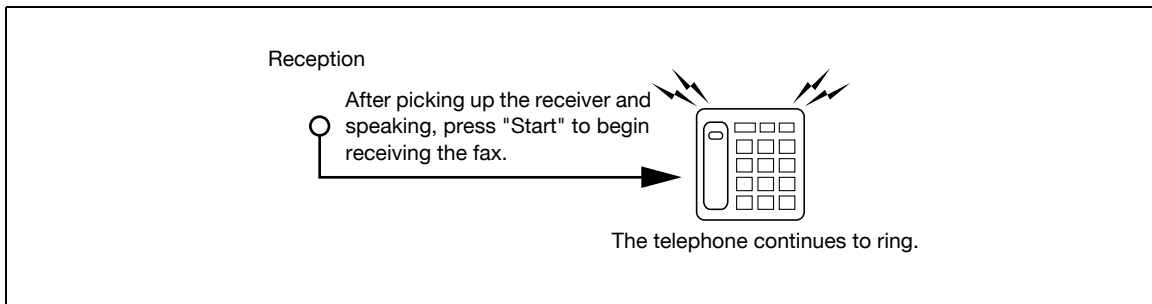

#### Tips

- Manual RX is available when a phone is connected to the external phone connector of this machine. To use manual RX, set [RX MODE] to [MANUAL RX] in the Utility screen. For details, refer to page 7-26.

- 1 When the phone rings, pick up the receiver and speak to the sender.
- 2 When you hear the sound "po, po, po" through the receiver after speaking, press the **Start** key.  
Transmission starts.
  - If the destination is set to the Auto TX mode, you may not hear the sound "po, po, po...".
  - When necessary, you can switch to the fax receiving mode after receiving an incoming call through an external phone.
- 3 Put down the receiver. When the receiving process ends, a "long beep" sounds.

## 3.15 Making a call

This machine can be used as a phone when it is connected to an external phone.

- 1 Pick up the phone receiver.  
→ Check that you hear a dial tone "long beep" through the receiver.
- 2 Dial a destination number.
- 3 When a connection is made, speak to the recipient.
- 4 After finishing the conversation, put down the receiver.

## 3.16 Receiving a call

This section explains how to receive a call when this machine is connected to an external phone.

When [RX MODE] is set to [MANUAL RX], you can receive a call.

- 1 When the phone rings, pick up the receiver and speak to the sender.
- 2 After finishing the conversation, put down the receiver.

---



## **Convenient Transmission and Receiving Functions**





## 4 Convenient Transmission and Receiving Functions

### 4.1 Transmission with F-Code (F-Code TX)

This machine supports F-code communication defined by the Communications and Information network Association of Japan (CIAJ).

The F code is a mail box function that uses SUB (SUB address), SEP (selective polling), [SID], and [PWD] (password) that are defined in the G3 standard of the International Telecommunication Union (ITU-T).

Specify the following F code using the **Keypad** to suit your environment.

F-Code	Contents
SUB	Specify this option when sending a fax using an F code. This code can be specified using up to 20 digits.
PASSWORD (SID)	Specify this option when restricting recipients with a password. This code can be specified using up to 20 digits.
POLL ID (SEP)	Specify this option when the recipient makes a call to ask the sender to send the original prepared in the sender side to the recipient.

#### Tips

- The F-code function is available only in fax machines that supports the F-code function. Before configuring settings, check that both the machines support the F-code function.
- If an F code (SUB or SID) is registered in the one-touch dial or speed dial in advance, you can establish an F-code communication.
- A confidential communication is available between machines compatible with an F code.

#### 4.1.1 Specifying an F code at fax transmission

Specify an F code when typing in a fax number directly using the **Keypad**.

- 1 Enter a destination fax number using the **Keypad**.
- 2 Press **▼**.
- 3 Use **▲▼** to select [SUB, SID SETTING], and press the **OK** key.
- 4 Enter a SUB address using the **Keypad**, and press the **OK** key.
  - To correct a numeric value, press the **Start/Stop** key.
  - When entering a password, go to Step 5.
  - When not entering a password, press the **OK** key, and go to Step 6.
- 5 Enter the password using the **Keypad**, and press the **OK** key.

```
SUB, SID SETTING
SUB
: 5555
SID
: 98765_
```

- To correct a numeric value, press the **Clear/Stop** key.

- 6 Press the **Start** key.  
This starts scanning and sending.

### 4.1.2 Specifying an F code to register a destination

When registering one-touch dial or speed dial, specify an F code.

- 1 Enter a destination fax number using the **Keypad**.

```
SPEED DIAL 001
DESTINATION
:0123 45 789_ [1...]
-----
OTHER SETTING= ▼
```

- 2 Press ▼.
- 3 Use ▲▼ to select [SUB, SID SETTING], and press the **OK** key.
- 4 Enter a SUB address using the **Keypad**, and press the **OK** key.
  - To correct a numeric value, press the **Clear/Stop** key.
  - When entering a password, go to Step 5.
  - When not entering a password, press the **OK** key, and go to Step 6.
- 5 Enter the password using the **Keypad**, and press the **OK** key.

```
SUB, SID SETTING
SUB
:5555
SID
:98765_
```

→ To correct a numeric value, press the **Clear/Stop** key.

- 6 Press **OK**.  
Continuously, register other items.

## 4.2 Using a Confidential User Box for sending and receiving (Confidential communication)

The confidential communication is a function used to transfer an original between you and specific persons using the Confidential User Box. This function requires a User Box ID, enabling you to safely transfer a confidential document by fax.

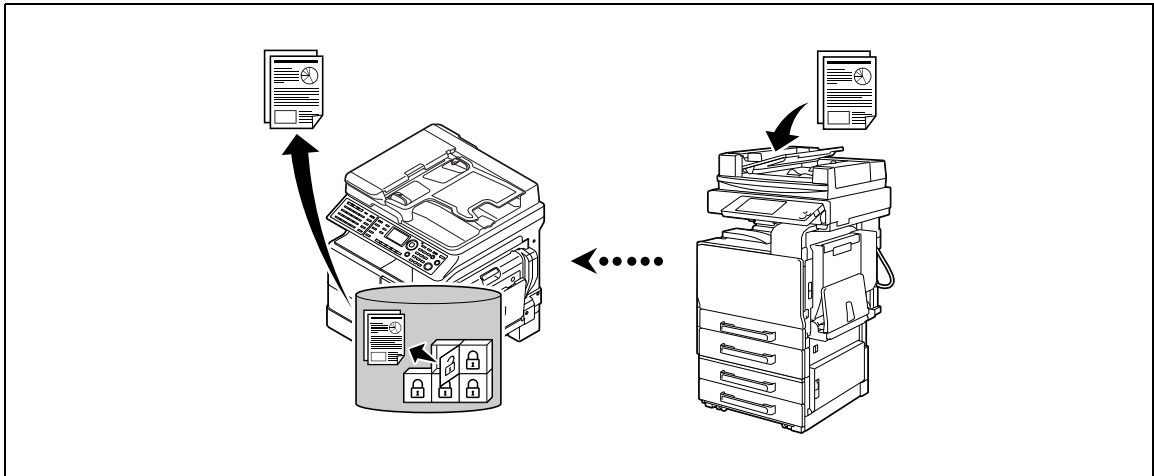

Sending an original to a Confidential User Box of the recipient machine is referred to as confidential transmission, and receiving an original in a Confidential User Box of your machine is referred to as confidential reception.

### Reference

*This machine supports up to five Confidential User Boxes. For details, refer to page 7-17.*

*If an F code of a destination is registered in one-touch dial or speed dial in advance, an F-code communication can be sent to a destination. For details, refer to page 4-3.*

This section explains how to register a Confidential User Box, use a confidential transmission, and print out a received original in a Confidential User Box.

### 4.2.1 Registering a Confidential User Box

To use the confidential reception, you must register a Confidential User Box in advance. For details on the registration procedure, refer to page 7-17.

### 4.2.2 Sending data to a Confidential User Box (Confidential transmission)

The confidential transmission is a function used to send data to a Confidential User Box of a destination.

It is available when sending an important document to a specific person.

Tips

- The confidential transmission function supports F-code communication. A machine compatible with an F code can be selected as a destination of confidential transmission.
- To use this function, specify a destination and configure a Confidential User Box setting.
- To check a fax document in the destination side, enter a User Box ID.

**1** Load the original.

→ For details on how to load the original, refer to page 3-5.

**2** When necessary, specify a desired option for [QUALITY].

For details on [QUALITY], refer to page 3-7.

**3** Press the **Function** key.

**4** Use ▲▼ to select [MAILBOX TX], and press the **OK** key.

**5** Enter a destination fax number using the **Keypad**, and press the **OK** key.

→ For details on how to specify a destination, refer to page 3-8.

**6** Enter a User Box ID using the **Keypad**, and press the **OK** key.

→ Specify a User Box ID (SUB) registered in the Confidential User Box of a destination with up to 20 digits.

→ The characters available for a User Box ID are only 0 to 9, \*, and #.

→ If you specify a destination with a SUB address registered in a **One-Touch Dial Key** or Speed Dial, the SUB address is displayed. Change the numeric value as necessary.

→ To correct a numeric value, press the **Clear/Stop** key.

**7** Enter the password using the **Keypad**, and press the **OK** key.

```
MAILBOX TX
MAILBOX ID

: 1234
PASSWORD

: 5678
```

→ If a password is specified for a Confidential User Box of a destination, enter it with up to 20 digits.

→ The characters available for a password are only 0 to 9, \*, and #.

→ To correct a numeric value, press the **Clear/Stop** key.

**8** Press the **Start** key.

This starts scanning and sending.

### 4.2.3 Printing out an original received by confidential reception

The confidential reception function is available only when the User Box ID and password specified in a remote machine match those registered on this machine.

If a Confidential User Box contains a received original,  is displayed in the basic screen.

Tips

- To use the confidential reception, you must register a Confidential User Box in advance. For details on the registration procedure, refer to page 7-17.

This example shows how to print out an original received by the confidential reception.

- 1 Press the **Function** key.
- 2 Use **▲▼** to select [PRINT MAILBOX RX], and press the **OK** key.
- 3 Enter a 4-digit User Box ID using the **Keypad**, and press the **OK** key.

```
PRINT MAILBOX RX
MAILBOX ID
: 1234
```

→ To correct a numeric value, press the **Clear/Stop** key.

## 4.3 Sending a document with a receiver's instruction (Polling TX)

### 4.3.1 Using Polling TX

Polling TX is a function that saves an original in the memory in advance to enable it to be sent it based on a receiver's polling instruction.

An original with polling TX specified is saved in a Polling TX User Box of a Confidential User Box, and it is sent when the recipient instructs polling TX.

If a Confidential User Box contains an original for polling TX,  is displayed in the basic screen.

Tips

- The polling TX function supports F-code communication.
- Up to 30 polling TX sessions can be registered.
- If the memory is full, polling TX is not available.
- When using polling TX, note that communication costs are to be borne by the receiver.

This example shows how to carry out polling TX using a Polling TX User Box.

- 1 Load the original.
  - For details on how to load the original, refer to page 3-5.
- 2 When necessary, specify a desired option for [QUALITY].
  - For details on [QUALITY], refer to page 3-7.
- 3 Press the **Function** key.
- 4 Use **▲▼** to select [POLLING TX], and press the **OK** key.
- 5 Use **▲▼** to select [SINGLE] or [MULTI], and press the **OK** key.
  - When deleting an original in the memory to handle only a single polling TX request, select [SINGLE].
  - To handle multiple polling TX requests, select [MULTI]. Originals in the memory are saved until they are deleted by canceling a reservation.
  - When not specifying a polling ID, skip to Step 8.
- 6 Enter a 4-digit polling ID using the **Keypad**, and press the **OK** key.
  - For polling ID, specify a numeric value between 0000 and 9999.
  - When registering only one polling TX job, you do not need to specify a polling ID or password.
  - To correct a numeric value, press the **Clear/Stop** key.
  - When not specifying a password, press the **OK** key, and go to Step 8.
- 7 Enter a 4-digit password using the **Keypad**, and press the **OK** key.

```
POLLING TX
POLL ID
: 1 2 3 4
PASSWORD
: 5 6 7 8
```

- For password, specify a numeric value between 0000 and 9999.
- To correct a numeric value, press the **Clear/Stop** key.

8 Press the **Start** key.

→ This starts scanning, and changes to the standby state.

If a Confidential User Box contains a received document,  is displayed in the basic screen.

Tips

- To stop a registration during scanning, press the **Clear/Stop** key, and press [YES] in the displayed screen.
- To cancel polling TX, press the **Function** key, and select [CANCEL RESERV.]. For details, refer to page 3-20.

### 4.3.2 Deleting a document sent by polling

1 Press the **Function** key.

2 Use ▲▼ to select [POLLING TX], and press the **OK** key.

3 Use ▲▼ to select [SINGLE] or [MULTI], and press the **OK** key.

4 Enter a 4-digit polling ID using the **Keypad**, and press the **OK** key.

5 Use ▲▼ to select [DELETE], and press the **OK** key.

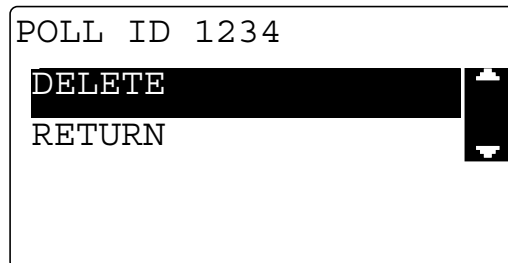

## 4.4 Receiving a sender's document with an instruction of this machine (Polling RX)

Polling RX is a function that sends an original loaded in the sender side or an original saved by a polling TX reservation following a recipient's instruction. This is convenient when communication costs are to be borne by the receiver.

### Tips

- Up to 255 destinations can be specified.
- When using a **One-Touch Dial Key**, up to 32 destinations can be specified.
- When using Speed Dial, up to 250 destinations can be specified.
- When entering a fax number, up to 16 destinations can be specified.
- The polling RX function supports F-code communication.

- 1 Press the **Function** key.
- 2 Use **▲▼** to select [POLLING RX], and press the **OK** key.
- 3 Specify a destination.
  - For details on how to specify a destination, refer to page 3-8 or page 3-15.
- 4 To enter a polling ID or password, press the **▼** key.

```
POLLING RX          1/255
DESTINATION
: AAABBCC
-----
POLL ID SETTING =▼
```

→ When not entering a polling ID or password, press the **OK** key, and go to Step 7.

- 5 Enter a polling ID with up to 20 digits using the **Keypad**, and press the **OK** key.
  - To correct a numeric value, press the **Clear/Stop** key.
- 6 Enter a password with up to 20 digits using the **Keypad**, and press the **OK** key.

```
POLLING RX
POLL ID
: 1234
PASSWORD
: 5678_
```

→ To correct a numeric value, press the **Clear/Stop** key.

- 7 To specify multiple destinations, select [ADD], and repeat Steps 3 to 6.
- 8 Press the **Start** key.



## 4.5 Specify a relay distribution station for transmission (Relay Instruction transmission)

The relay instruction transmission is a function that sends an original to a relay distribution station once, and broadcasts it from the relay distribution station to destinations. When there are multiple jobs to broadcast a document to distant destinations, group relay distribution stations and relay distribution destinations for each region, enabling a reduction of the entire communication charge

### Tips

- The relay instruction transmission function supports F-code communication.
- For a relay distribution station, specify a model compatible with the relay broadcasting. This machine can be specified as a relay distribution station.
- The relay instruction transmission cannot be used together with the confidential transmission.
- To specify the relay instruction transmission, you must register a Relay User Box ID in a relay distribution station in advance. For details, refer to page 7-19.

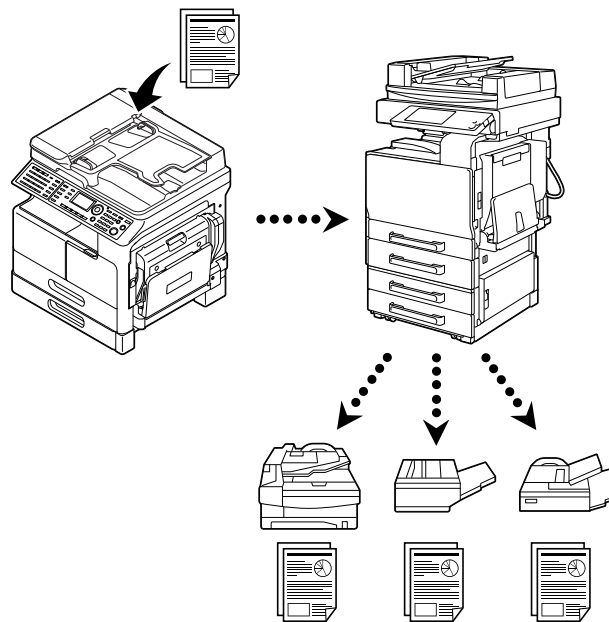

- 1 Load the original.  
→ For details on how to load the original, refer to page 3-5.
- 2 When necessary, specify a desired option for [QUALITY].  
→ For details on [QUALITY], refer to page 3-7.
- 3 Press the **Function** key.
- 4 Use ▲▼ to select [RELAY INITIATE], and press the **OK** key.
- 5 Specify a relay distribution station, and press the **OK** key.  
→ For details on how to specify a relay distribution station, refer to page 3-8.
- 6 Enter a Relay User Box ID using the **Keypad**, and press the **OK** key.  
→ Enter a Relay User Box ID registered in a relay distribution station with up to 20 digits.  
→ The characters available for a Relay User Box ID are only 0 to 9, \*, and #.  
→ To correct a numeric value, press the **Clear/Stop** key.

- 7 Enter the password using the **Keypad**, and press the **OK** key.

```
RELAY INITIATE
RELAY BOX ID
: 1234
PASSWORD
: 5678_
```

- If a password is specified for a relay distribution station, enter it with up to 20 digits.
- The characters available for a password are only 0 to 9, \*, and #.
- To correct a numeric value, press the **Clear/Stop** key.

- 8 Press the **Start** key.

This starts scanning and sending.

## 4.6 Specify this machine as a relay distribution station (Relay broadcasting)

This machine can be specified as a relay distribution station.

If this machine is specified as a relay distribution station, it receives an original sent from other fax machine (relay instruction station) once, and send it to multiple destinations (receiving stations).

### Tips

- The relay broadcasting function supports F-code communication.
- The same value cannot be registered between the Relay User Box ID and Confidential User Box ID.
- When using the **One-Touch Dial Key**, speed dial, or group dial, up to 50 destinations can be specified.
- A document received by a relay distribution station is printed out.

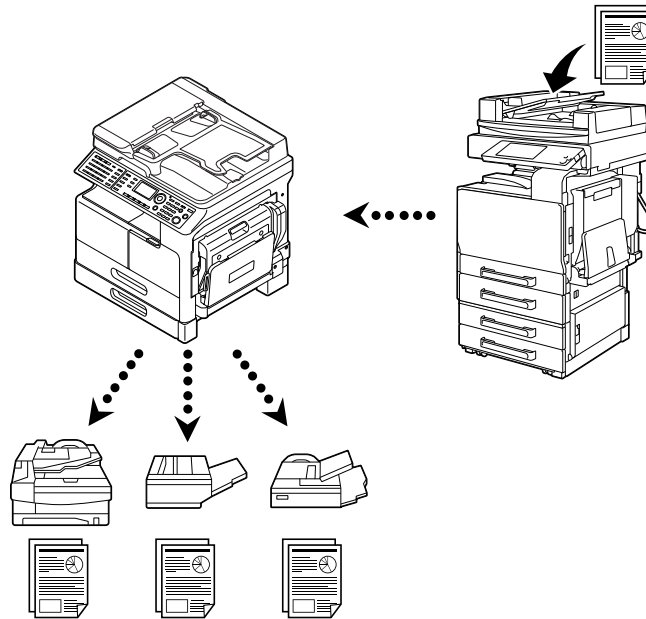

To specify the relay broadcasting, you must register a 4-digit Relay User Box ID and receiving stations (last destinations) in advance. Up to 10 Relay User Boxes can be specified. For details, refer to page 7-19.

## 4.7 Forwarding a received document to the specified destination (Forward)

Forward is a function that sends a received document to the destination specified on this machine.

A forward destination can be specified with a fax number or E-mail address.



### Reference

*For details on how to specify a forward destination, refer to page 7-26.*

### Tips

- To forward to an E-mail address, you need to install an optional **Image Controller IC-209** or **Network Card NC-504** in advance.



### Reference

*To erase a forwarded document, refer to page 3-20.*

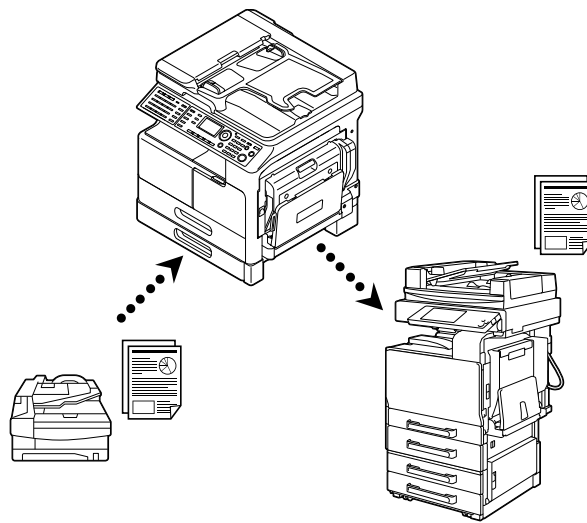



**Internet Fax**

---



## 5 Internet Fax

To use the Internet fax function, you need to install the **FAX Kit FK-510** and **Extended Operation Panel MK-749** as well as optional **Image Controller IC-209** or **Network Card NC-504** in advance.

### 5.1 Transmitting an Internet fax

#### 5.1.1 Transmitting an Internet fax

Before using Internet Fax, configure the following items. Incorrect settings will result in a communication error, leading to a sending failure.

- IP address
- Subnet mask
- Gateway
- Sender name
- Sender's E-mail address
- SMTP server address
- SMTP port number
- SMTP server timeout
- Text insertion
- Subject



#### Reference

For details on each setting, refer to the *[User's Guide Network Administrator]*.

#### 5.1.2 Basic transmission procedure

- 1 Press the **Fax** key.  
This changes to the fax mode and displays the fax screen.
- 2 Load the original.  
→ For details on how to load the original, refer to page 3-5.
- 3 When necessary, specify a desired option for [QUALITY].  
→ For details on [QUALITY], refer to page 5-10.
- 4 Press the **A...1...** key.
- 5 Enter a destination E-mail address using the one-touch dial, speed dial, or **Keypad**.

```

12:00      MEMORY : 100%
QUALITY : STD/TEXT
☎:st@test.local_ [A...]
-----
OTHER SETTING =▼

```

- When necessary, press ▼ to specify the transmission time or select the Basic or Advanced mode. For details, refer to page 5-7.

- 6** Press the **Start** key.
- This starts scanning and sending if the original has been loaded onto the **ADF**. After sending is completed, a "long beep" sounds.
  - To stop sending, press the **Clear/Stop** key, and select [YES] in the displayed screen.
  - If you load the original on the **Original Glass**, go to step 7.
- 7** Use ▲▼ to select [AUTO DETECTION] or [MANUAL], and press the **OK** key.
- 8** To start scanning, press the **OK** key.
- When changing the scanning paper size, press ▼ to respecify the size.
- 9** When continuously scanning the original, load the next original, and press the **OK** key.
- Repeat this procedure until scanning of originals is completed.

12:00	MEMORY: 100%
QUALITY: STD/TEXT	
NEXT PAGE? (AUTO)	1
SCAN=OK (TX=START)	

- 10** When scanning of all originals has been completed, press the **Start** key.
- Sending starts.
- The Internet fax communication supports the following functions in the same way as for a fax communication using a telephone line.
    - Sequential broadcast transmission (p. 3-15)
    - Specified-time transmission (p. 3-25)
    - Relay broadcasting (p. 4-13)
    - Forward (p. 4-14)
- After sending is completed, a "long beep" sounds.
- To stop sending, press the **Clear/Stop** key, and select [YES] in the displayed screen.



### Reference

*To cancel sending the scanned document, refer to page 3-20.*

*If a transmission fails, a transmission result report is printed out. For details, refer to page 3-21.*



### 5.1.3 Using the Address Book for search (Address Search)

An E-mail address can be searched from the Address Book. Address Search is a function that recalls an E-mail address registered in the LDAP server. To search for a target E-mail address, enter a part of its character string or a destination name.



#### Reference

To use Address Search, configure LDAP settings in advance. For details, refer to the [User's Guide Network Administrator].

This example shows how to recall an E-mail address registered in [Destination name: AAA TOKYO, E-mail address: aatokyo@test.local].

- 1 Load the original.
- 2 When necessary, specify a desired option for [QUALITY].  
→ For details on [QUALITY], refer to page 5-10.
- 3 Press **AddressBook**.
- 4 Use ▲▼ to select [LDAP SEARCH], and press the **OK** key.
- 5 Use ▲▼ to select [NAME] or [E-MAIL], and press the **OK** key.
- 6 Enter a destination name or a character string included in an E-mail address using the **Keypad**, and press the **OK** key.  
→ If you select [NAME] in Step 5, enter a character string included in the name.

```
LDAP SEARCH (NAME)
: T0
[A...]
```

- If you select [E-MAIL] in Step 5, enter a character string included in the E-mail address.
- Up to 10 characters can be specified for a character string.

- 7 Use ▲▼ to select a name or E-mail address, the press the ► key.  
→ If you select [NAME] in Step 5, specify "AAA TOKYO" for the name.  
→ If you select [E-MAIL] in Step 5, specify "aatokyo@test.local" for the E-mail address.  
This displays the screen to confirm the selected destination.

- 8 Press **OK**.

```
AAA TOKYO
aatokyo@test.local

-PRESS OK KEY-
```

- This recalls the E-mail address of the selected destination, and returns to the fax number entry screen.  
→ To return to Step 7, press the **Back** key.

- 9 Press the **Start** key.  
This starts scanning and sending.

## 5.2 Configuring transmission settings

Press ▼ in the E-mail address entry screen to configure the following transmission settings.

- Transmission time
- Maximum transmission size
- Maximum transmission resolution
- Compression coding method

To specify the transmission time, select [TIMER SETTING]. To specify the maximum transmission size, maximum transmission resolution, and compression coding method, select [BASIC/ADVANCED].

### 5.2.1 Specifying the transmission time



#### Reference

*For details on the basic transmission procedure, refer to page 5-3.*

- 1 Load the original, and specify a destination.
- 2 Press ▼.
- 3 Use ▲▼ to select [TIMER SETTING], and press the OK key.
- 4 Enter the transmission time using the **Keypad**, and press the **OK** key.

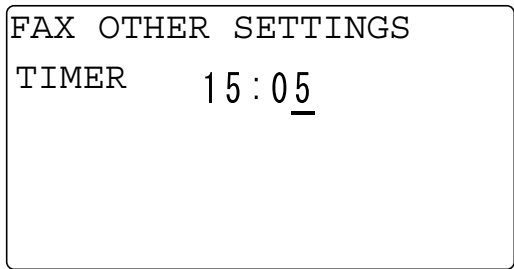

```
FAX OTHER SETTINGS
TIMER      15:05
```

- 5 Press the **Back** key.  
This returns to the E-mail address entry screen.

## 5.2.2 Selecting the Basic or Advanced mode



### Reference

For details on the basic transmission procedure, refer to page 5-3.

- 1 Load the original, and specify a destination.
- 2 Press ▼.
- 3 Use ▲▼ to select [BASIC/ADVANCED], and press the **OK** key.
- 4 Use ▲▼ to select [BASIC] or [ADVANCED], and press the **OK** key.
  - Selecting [BASIC] returns to the FAX OTHER SETTINGS screen.
  - If [BASIC] is selected, each item is set as shown below.
    - [MAX TX SIZE]: [A4]
    - [MAX QUALITY]: [FINE]
    - [CODING METHOD]: [MH]
  - If you select [ADVANCED], go to a desired step in page 5-8.

## 5.2.3 Specifying the maximum transmission size

- 1 Select [ADVANCED] in the screen that enables selection of the Basic or Advanced mode, and press the **OK** key.
  - For details on how to display the screen that enables selection of the Basic or Advanced mode, refer to page 5-8.
- 2 Use ▲▼ to select [MAX TX SIZE], and press the **OK** key.
- 3 Use ▲▼ to select [A3], [B4], or [A4], and press the **OK** key.
- 4 Select [RETURN] twice in the displayed screen.

This returns to the E-mail address entry screen.

## 5.2.4 Specifying the maximum transmission resolution

- 1 Select [ADVANCED] in the screen that enables selection of the Basic or Advanced mode, and press the **OK** key.
  - For details on how to display the screen that enables selection of the Basic or Advanced mode, refer to page 5-8.
- 2 Use ▲▼ to select [MAX QUALITY], and press the **OK** key.
- 3 Use ▲▼ to select [FINE] or [S-FINE], and press the **OK** key.
- 4 Select [RETURN] twice in the displayed screen.

This returns to the E-mail address entry screen.

### 5.2.5 Specifying the compression coding method

- 1 Select [ADVANCED] in the screen that enables selection of the Basic or Advanced mode, and press the **OK** key.  
→ For details on how to display the screen that enables selection of the Basic or Advanced mode, refer to page 5-8.
- 2 Use ▲▼ to select [CODING METHOD], and press the **OK** key.
- 3 Use ▲▼ to select [MH], [MR], or [MMR], and press the **OK** key.
- 4 Select [RETURN] twice in the displayed screen.  
This returns to the E-mail address entry screen.

## 5.3 Specifying the image quality and density when scanning the original

### 5.3.1 Specifying the image quality

- 1 Press the **Quality** key.
- 2 Use **▲▼** to select the image quality, and press the **OK** key.
  - To specify the super-fine image quality, select [ADVANCED] - [MAX QUALITY] - [S-FINE] in the [BASIC/ADVANCED] setting. For details on the setting procedure, refer to page 5-8.This returns to the basic screen.

### 5.3.2 Specifying the density

- 1 Press the **Density** key.
- 2 Use **◀▶** to select a desired one from five density levels, and press the **OK** key.  
This returns to the basic screen.

## 5.4 Adding functions

### 5.4.1 Specifying a title

Assign a title to an E-mail to be sent.

- 1 Press the **Utility** key.
- 2 Use **▲▼** to select [ADMIN. MANAGEMENT], and press the **OK** key.
- 3 Enter the administrator number using the **Keypad**, and press the **OK** key.  
→ To correct a numeric value, press the **Clear/Stop** key.
- 4 Use **▲▼** to select [E-MAIL SETTING 1], and press the **OK** key.
- 5 Use **▲▼** to select [DEFAULT SUBJECT], and press the **OK** key.
- 6 Enter a title using the **Keypad**, and press the **OK** key.

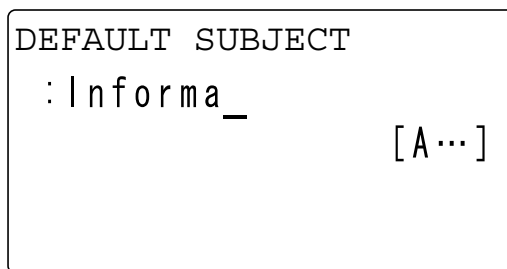

```
DEFAULT SUBJECT
: Informa_
[A...]
```

This returns to the E-mail Setting 1 screen.

### 5.4.2 Specifying a forward destination

If a receiving error occurs, a receiving result report is sent to the address specified in this step.

- 1 Press the **Utility** key.
- 2 Use **▲▼** to select [ADMIN. MANAGEMENT], and press the **OK** key.
- 3 Enter the administrator number using the **Keypad**, and press the **OK** key.  
→ To correct a numeric value, press the **Clear/Stop** key.
- 4 Use **▲▼** to select [E-MAIL SETTING 2], and press the **OK** key.
- 5 Use **▲▼** to select [REPLY ADDRESS], and press the **OK** key.
- 6 Enter a forward destination address using the **Keypad**, and press the **OK** key.

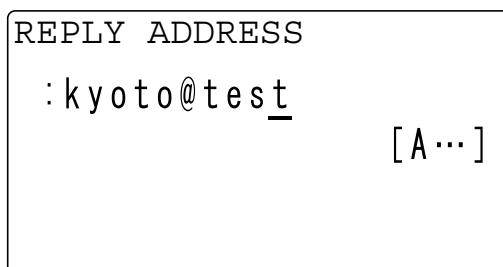

```
REPLY ADDRESS
: kyoto@test_
[A...]
```

This returns to the E-mail Setting 2 screen.

### 5.4.3 Specifying header printing

- 1 Press the **Utility** key.
- 2 Use **▲▼** to select [ADMIN. MANAGEMENT], and press the **OK** key.
- 3 Enter the administrator number using the **Keypad**, and press the **OK** key.
  - The factory default of the administrator number is "000000".
  - To correct a numeric value, press the **Clear/Stop** key.
- 4 Use **▲▼** to select [E-MAIL SETTING 2], and press the **OK** key.
- 5 Use **▲▼** to select [HEADER PRINT], and press the **OK** key.
- 6 Use **▲▼** to select [OFF] or [ON], and press the **OK** key.

This returns to the E-mail Setting 2 screen.



## 5.5 Receiving an Internet fax

This machine supports receiving Internet faxes as well as transmitting Internet faxes. This section explains how to receive an Internet fax.

### 5.5.1 Receiving an Internet fax

Before receiving an Internet Fax, configure the following items. Incorrect settings will result in a communication error, leading to a receiving failure.

- IP address
- Subnet mask
- Gateway
- POP3 server
- POP3 port number
- POP3 timeout
- POP3 account
- POP3 password
- Auto RX (p. 5-14)
- Forward address (p. 5-11)
- Header printing (p. 5-12)



#### Reference

*For details on each setting other than auto RX, forward address, and header printing, refer to the [User's Guide Network Administrator].*

### 5.5.2 Receivable data

The available data types are as follows.

- Text data
- TIFF image
- Mixed data of text and TIFF image
- JPEG image

The following type of data may not be received.

- File type dedicated to application

### 5.5.3 Receiving an Internet fax automatically

- 1 Press the **Utility** key.
- 2 Use **▲▼** to select [ADMIN. MANAGEMENT], and press the **OK** key.
- 3 Enter the administrator number using the **Keypad**, and press the **OK** key.  
→ To correct a numeric value, press the **Clear/Stop** key.
- 4 Use **▲▼** to select [E-MAIL SETTING 2], and press the **OK** key.
- 5 Use **▲▼** to select [AUTO RECEPTION], and press the **OK** key.
- 6 Use **▲▼** to select [ON].
- 7 Enter the receiving interval using the **Keypad**, and press the **OK** key.  
→ For automatic receiving, the receiving interval can be specified between 1 and 60 min.

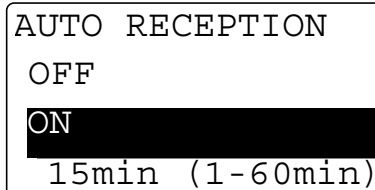

```
AUTO RECEPTION
OFF
ON
15min (1-60min)
```

This returns to the E-mail Setting 2 screen.

### 5.5.4 Receiving an Internet fax manually

- 1 Press the **Function** key.
- 2 Use **▲▼** to select [INTERNET FAX RX], and press the **OK** key.
- 3 Use **▲▼** to select [RECEIVE E-MAIL], and press the **OK** key.  
When an E-mail is sent from a sender, it is received and printed on this machine.

---



**6** **PC-FAX**



## 6 PC-FAX

### 6.1 Overview of PC-Fax

#### 6.1.1 PC-FAX

PC-FAX is a function that sends a document created by an application such as word-processing software to a destination fax via the machine modem without printing it by only specifying a fax number on a PC. However, it cannot be received directly by a computer.

To use the PC-FAX transmission, install the fax driver supplied with this machine on your computer.

#### Tips

To use the PC-FAX function, you need the following items.

- If this machine and the computer are connected via USB:
  - **FAX Kit FK-510**
  - **Extended Operation Panel MK-749**
- If this machine and the computer are connected via network:
  - **FAX Kit FK-510**
  - **Extended Operation Panel MK-749**
  - **Image Controller IC-209** or **Network Card NC-504**

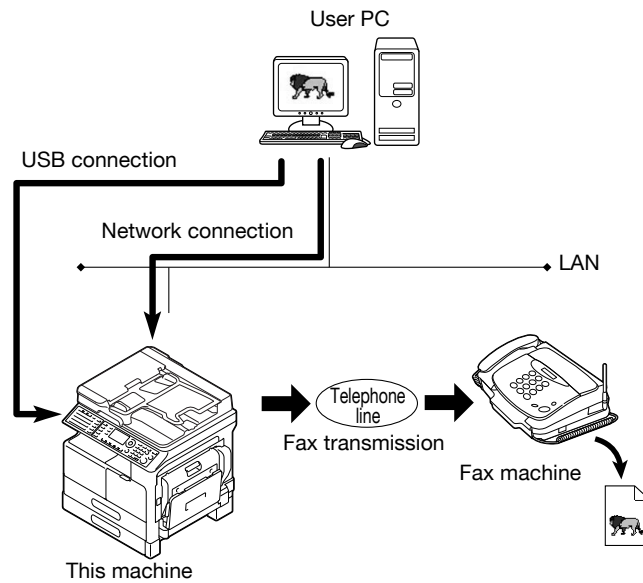

## 6.1.2 Operating environment

The following operating environment is required to use the fax driver.

### Operating environment

Operating system	Windows Vista (x86/x64) Windows Server 2008 (x86/x64) Windows Server 2008 R2 (x64) Windows 7 (x86/x64) Windows 8 (x86/x64) Windows 8.1 (x86/x64) Windows Server 2012 (x64) Windows Server 2012 R2 (x64)
CPU	Any processor of the same or higher specifications as recommended for your operating system.
Memory	Memory capacity as recommended for your operating system. Sufficient memory resource is required for your operating system and the applications to be used.
Port	Ethernet 10Base-T/100Base-TX USB port compatible with USB Revision 2.0
Drive	CD-ROM/DVD drive

### 6.1.3 Setup procedure

The setup refers to a series of procedures for connecting this machine to the computer and installing the fax driver to the computer.

Perform the setup using the following procedures.

Tips

- When updating an existing fax driver, uninstall it first. For details, refer to page 6-6.

#### USB connection

- 1 Connect this machine to the computer using a USB cable.
- 2 Install the fax driver.



#### Reference

For details on the USB interface, refer to the [User's Guide Printer Operations].

#### Network connection

- 1 Connect this machine to the computer.
- 2 Check that the computer to be used is connected to the network.
- 3 Specify the IP address of this machine, and then connect it to the network.
- 4 Change the network settings for this machine according to the connection method or protocol.
  - LPR: Select [TCP/IP Configuration] - [LPD Setting], and enable LPD printing.
  - Port 9100: Select [IPv4 Configuration], and enable the RAW port number (default: [9100]).
- 5 Install the fax driver.
  - Specify the network port for the fax driver according to the connection method or protocol.



#### Reference

For details on Ethernet, refer to the [User's Guide Printer Operations].

For details on the network settings of the machine, refer to **PageScope Web Connection** - [Network] - [TCP/IP Configuration] and [Network] - [IPv4 Configuration] in [User's Guide Network Administrator].

## 6.2 Installing the fax driver

### 6.2.1 Connection method and installation procedure

Before you can use this printing system, you must install the fax driver. The fax driver refers to the program that controls such operations as processing of data to be output. Before using this printing system, install the fax driver from the attached DVD to your computer.

The fax driver installation method differs depending on the operating system and connection method to be used.

#### Tips

- Log in with an administrator user account and install the fax driver.
- This printer driver is not supported in the IPv6 environment.



#### Reference

*For details on the connection method, refer to the [User's Guide Printer Operations].*

*For details on the settings in the network environment, refer to the [User's Guide Network Administrator].*

### 6.2.2 Uninstalling the fax driver

This section describes how to delete the fax driver.

When you have to remove the fax driver, for example, when reinstallation of the fax driver is necessary, remove the driver using the following procedure.

#### Manual uninstallation

Removing the fax driver manually

- 1 Open the [Printers], [Devices and Printers], or [Printers and Faxes] window.
- 2 Select the icon of the fax to be removed.
- 3 Remove the fax driver.
  - In Windows Vista/Server 2008, press the Delete key on the computer keyboard.
  - In Windows 7/8/8.1/Server 2008 R2/Server 2012/Server 2012 R2, click [Remove device] on the toolbar.
- 4 From then on, follow the instructions on the pages that follow.

When removal is completed, the icon will disappear in the [Printers], [Devices and Printers], or [Printers and Faxes] window.

Remove the fax driver from the server properties.
- 5 Open the [Server Properties].
  - In Windows Vista/Server 2008, right-click on the area that has nothing displayed in the [Printers] window, then click [Run as administrator] - [Server Properties].
  - In Windows 7/8/8.1/Server 2008 R2/Server 2012/Server 2012 R2, select other printer, then click [Print Server Properties] on the toolbar.
  - Depending on the settings on the computer, the UAC (User Account Control) dialog box may appear. Check the details, and continue.
- 6 Click the [Driver] tab.
- 7 From the [Installed printer drivers:] list, select the fax driver to be removed, and click [Remove...].
- 8 In a window confirming the target to be removed, select [Remove driver only.] or [Remove driver and driver package.], then click [OK].
- 9 In the dialog box for confirming whether you are sure to remove the target, click [Yes].
  - The dialog box appears to reconfirm if you are sure. Click [Delete].



- 10 Close the open windows, and then restart the computer.
  - Be sure to restart the computer.This completes removing the fax driver.

## 6.3 Sending a fax

### 6.3.1 Sending a fax

#### Tips

To use the PC-FAX function, you need the following items.

- If this machine and the computer are connected via USB:
  - **FAX Kit FK-510**
  - **Extended Operation Panel MK-749**
- If this machine and the computer are connected via network:
  - **FAX Kit FK-510**
  - **Extended Operation Panel MK-749**
  - **Image Controller IC-209 or Network Card NC-504**
- In the [Name] box, you can enter up to 32 characters.
- In the [Fax Number] box, you can enter up to 32 characters, including 0 to 9, +, -, \*, #, and P. To send a fax overseas, enter the country number at the beginning of the number.

1 Create data to be sent using application software.

2 In the [File] menu, select [Print].

3 In [Printer Name], select the [KONICA MINOLTA XXX (FAX)] that is installed.

4 If necessary, click [Properties] (or [Preferences]), and change the fax driver settings.

5 Click [Print].

The [Destination Settings] screen appears.

6 Specify a destination.

- To directly enter a destination, type the name and fax number into [Name] and [Fax Number], and click .
- To search for a destination in the address book, select a target from the list, and click .
- Right-click the group name of the address book to display the users registered in the group.

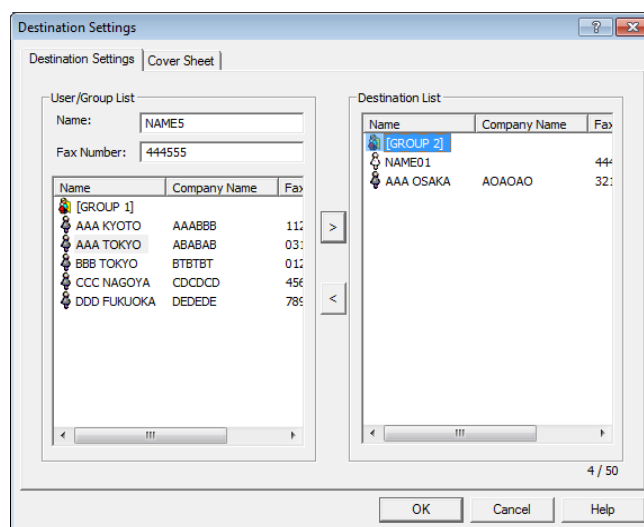

7 To specify multiple destinations, repeat Step 6.

- Up to 50 destinations can be specified, including destinations registered in the address book and group.
- To cancel a specified destination, select a target in [Destination List], and click .

8 Create a cover sheet as necessary.

- 9 Click [OK].  
The fax data is sent via this machine.

### Reference

For details on the fax driver settings, refer to page 6-10.

For details on how to register a destination in the address book, refer to page 6-12.

For details on how to create a cover sheet, refer to page 6-9.

## 6.3.2 Creating a fax cover sheet

A fax can be transmitted with a cover sheet attached.

- 1 In the [Destination Settings] screen, click the [Cover Sheet] tab.
- 2 Configure a cover sheet.

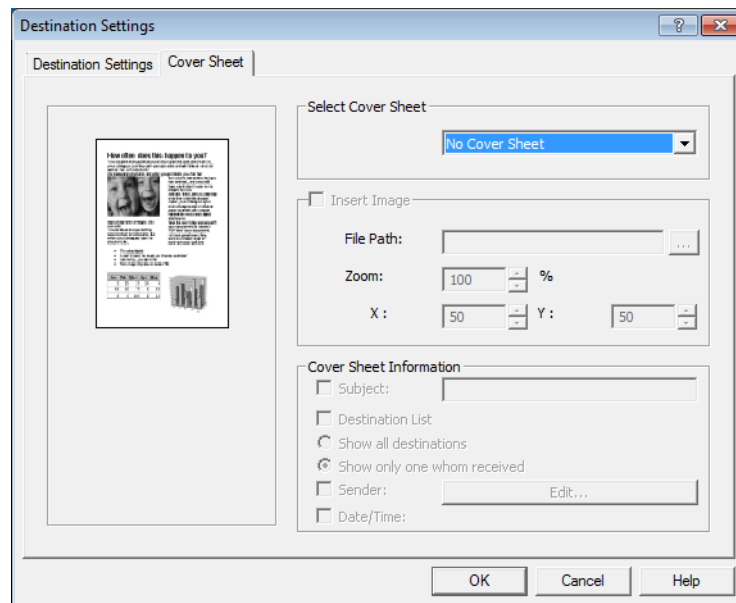

Item	Description
Select Cover Sheet	Select the style of a cover sheet. There are nine styles. The selected style is displayed in the left pane of the screen.
Insert Image	Select this check box to place an image on a cover sheet.
File Path	Specify an image you want to place on a cover sheet. The specifiable file type is BMP.
Zoom	Specify the size (10 to 400%) of a target image.
X	Specify the horizontal position (0 to 100) to place an image.
Y	Specify the vertical position (0 to 100) to place an image.
Cover Sheet Information	Select this check box to transmit a cover sheet with a subject.
Destination List	Select this check box to transmit a cover sheet with a destination list. Specify whether to attach a list to all destinations or to each destination.
Sender	Select this check box to transmit a cover sheet with sender information. Click [Edit] to edit sender information.
Date/Time	Select this check box to transmit a cover sheet with the Windows-base date and time.

## 6.4 Configuring fax driver settings

Configure each setting for the fax driver.

### 6.4.1 Basic settings

To configure the basic settings, select the [Settings] tab in the [Printing Preferences] screen.

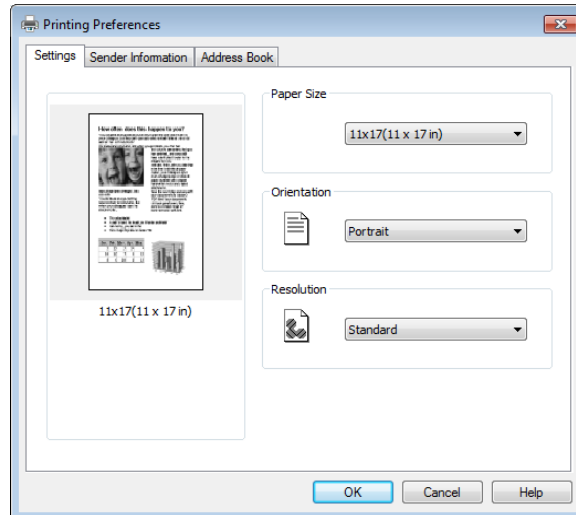

Item	Description
Page Layout	Displays the current settings. You can view a transmission result image.
Paper Size	Select the paper size of the original to be sent.
Orientation	Select the orientation of the original to be sent.
Resolution	Select the resolution.

### 6.4.2 Configuring sender information

To configure sender information, select the [Sender Information] tab in the [Printing Preferences] screen. Enter sender information, and click [OK].

The screenshot shows a 'Printing Preferences' dialog box with three tabs: 'Settings', 'Sender Information', and 'Address Book'. The 'Sender Information' tab is active. It contains the following fields and values:

- Name: AAA TOKYO
- Company Name: AAA
- Department: BBCCDD
- Telephone No.: 123456789
- Fax Number: 00112233
- E-mail Address: aa@jest.xxx
- Address: TOKYO

At the bottom of the dialog are three buttons: 'OK', 'Cancel', and 'Help'.

Item	Description
Name	Enter the sender name.
Company Name	Enter the company name of the sender.
Department	Enter the department name of the sender.
Telephone No.	Enter the telephone number.
Fax Number	Enter the fax number.
E-mail Address	Enter the E-mail address.
Address	Enter the address.

### 6.4.3 Registering a destination in the address book

To register a destination in the address book, select the [Address Book] tab in the [Printing Preferences] screen.

Tips

- Up to 1,000 destinations can be registered in the address book.

- 1 Click [Add User].
- 2 Enter destination information, and click [OK].

The screenshot shows a dialog box titled "Add User". It contains the following fields and values:

- Name (\*): AAA KYOTO
- Company Name: AAABBB
- Department: BBBAAA
- Telephone No.: 1122334455
- Fax Number (\*): 1122334455
- E-mail Address: email@xxx.xx
- Address: ADDRESS 1122

At the bottom, there are "OK" and "Cancel" buttons. A note at the bottom states: "(\*) Field must be filled in."

The entered information is displayed in the list.

### 6.4.4 Editing a destination in the address book

To edit a destination in the address book, select the [Address Book] tab in the [Printing Preferences] screen.

Tips

- Use [▼] in [View] to select a type to be displayed in the list.

- 1 Select a destination to be edited from the list, and click [Edit].
- 2 Edit destination information, and click [OK].



The screenshot shows a dialog box titled "Edit User". It contains the same fields and values as the "Add User" dialog, but the "Company Name" field is highlighted with a blue selection box, indicating it is the active field for editing.

### 6.4.5 Registering a group in the address book

To register a group, select the [Address Book] tab in the [Printing Preferences] screen.



Tips

- Up to 1,000 groups can be registered in the address book.
- Up to 50 destinations can be registered in one group.

- 1 Click [Add Group].
- 2 Enter a group name into [Name], select a target destination in [User List], and click .  
→ To cancel a registered destination, click .
- 3 After all destinations have been specified, click [OK].

### 6.4.6 Editing a group in the address book

To edit a destination in the address book, select the [Address Book] tab in the [Printing Preferences] screen.

- 1 Select a destination to be edited from the list, and click [Edit].
- 2 Use  and  to edit a target group, and click [OK].

### 6.4.7 Deleting a destination or group in the address book

To delete a destination or group in the address book, select the [Address Book] tab in the [Printing Preferences] screen.

- 1 Select a destination or group to be edited from the list, and click [Delete].  
The specified destination or group is deleted from the list.

### 6.4.8 Importing data to the address book

A CSV-type address can be imported to the address book.

Tips

- If the address data to be imported contains the same name as for the address book, a confirmation dialog box appears. Check the name.

- 1 On the [Address Book] tab, click [Import].  
The [Open] screen appears.
- 2 Specify a CSV file, and click [Open].
- 3 Specify the items of the import source in the items of the address book, and click [OK].  
→ Click [▼] to select the items of the import source from the list.

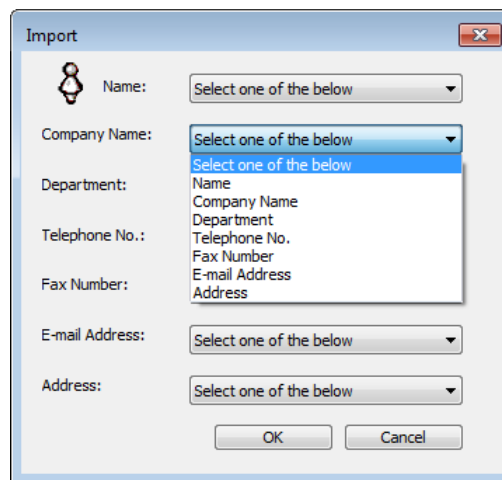

The specified data is imported to the address book.

### 6.4.9 Exporting data from the address book

Data in the address book can be saved in CSV format.

- 1 On the [Address Book] tab, click [Export].  
The [Save As] screen appears.
- 2 Enter the file name into [File name], and click [Save].  
Data in the address book is saved in CSV format.



---



## Utility and Fax Settings



## 7 Utility and Fax Settings

### 7.1 Utility settings

The Utility screen provides five fax setting items.

Tips

- Some items cannot be configured depending on which optional device is installed on this machine. If an item that cannot be configured is selected, an error message appears.

No.	Name	Description	Reference page
1	[DIAL REGISTRATION]	Register destinations in the one-touch dial, speed dial, and group dial.	p. 7-6
2	[FAX REGISTRATION]	Configure the default settings for each fax function.	p. 7-17
3	[FAX TX OPERATION]	Configure the default settings for transmission operations.	p. 7-21
4	[FAX RX OPERATION]	Configure the default settings for receiving operations.	p. 7-23
5	[REPORTING]	Configure the default settings for each report function.	p. 7-28



#### Reference

The items above, excluding No.2, can also be configured using LSU (Local Setup Utility). For details, refer to page 11-4.



#### Reference

For details on the following settings, refer to [User's Guide Copy Operation].

[MACHINE SETTING]: Set up the operating environment of this machine.

[PAPER SOURCE SETUP]: Specify the size and type of paper loaded in **Tray 1**.

[CUSTOM SIZE MEMORY]: Register a custom size.

[DRUM DEHUMIDIFY]: Perform maintenance operations to prevent a function reduction.

[ADMIN. MANAGEMENT]: Configure management settings for each account track, or specify the sleep mode.

[COPY SETTING 1/2]: Configure default settings of each copy function.



#### Reference

For details on the following settings, refer to [User's Guide Scan].

SCAN SETTING: Configure scanner settings.

In addition to No.1 to No.5, the following items can be configured if **FAX Kit FK-510** is installed on this machine. Press the **Utility** key, and configure the following settings as necessary.

Settings		Contents	Reference page	
[MACHINE SETTING]	[BUZZER VOLUME]	[DISABLE/ENABLE]	Specify whether to sound the machine status notification buzzer.	-
		[CONFIRMATION]	Specify the volume of the operation confirmation sound such as the input confirmation sound, invalid input sound, or basic sound.	-
		[COMPLETE]	Specify the volume of the successful completion sound such as the print operation completion sound or fax communication completion sound.	-
		[PREPARATION]	Specify the volume of the completed preparation sound.	-
		[CAUTION]	Specify the volume of the caution sound such as the simple caution sound levels 1 to 3, or a severe caution sound.	-
		[INITIAL MODE]	Select the initial mode. Select [COPY] or [FAX].	-
[ADMIN. MANAGEMENT]	[REMOTE MONITOR]		Configure the settings to remotely access this machine.	-
	[E-MAIL SETTING 1]	[E-MAIL MODE]	Specify the maximum transmission size, maximum transmission resolution, and compression coding method when transmitting an Internet fax. Select [ADVANCED] in the [E-MAIL MODE] screen, and configure each setting.	Each setting can be configured when transmitting an Internet fax. (p. 5-7)
	[E-MAIL SETTING 2]	[AUTO RECEPTION]	Configure the setting to automatically receive an Internet fax.	p. 5-14
		[REPLY ADDRESS]	Specify an address to send a receiving result report to when a receiving error occurs.	p. 5-11
		[HEADER PRINT]	Configure the setting to send a fax with a header.	p. 5-12

Settings			Contents	Reference page
[ADMIN. MANAGEMENT]	[COMM. SETTING]	[TONE/PULSE]	Specify the telephone line type such as the push telephone line or dialing telephone line.	p. 2-16
		[LINE MONITOR VOLUME]	Specify whether to make the line monitor sound audible through the speaker during communication.	p. 2-16
		[PSTN/PBX]	Specify the connected communication line such as [PSTN] or [PBX].	p. 2-17
[USER SETTING]	[DATE&TIME]		Specify the current date and time.	p. 2-12
	[DAYLIGHT SAVING]		Specify the time to switch to the daylight-saving time.	p. 2-13
	[USER FAX NUMBER]		Register the local fax number.	p. 2-14
	[USER NAME]		Register a sender name to be assigned to the header of the original to be sent.	p. 2-15

## 7.2 Store Address

This function allows you to register or change destinations or settings in the one-touch dial, speed dial, group dial, or program dial.

### 7.2.1 Registration items

No.	Store Address	Contents
1	[ONE-TOUCH DIAL]	Register a destination in a <b>One-Touch Dial Key</b> ; you can specify a destination easily and accurately without entering a telephone number using the <b>Keypad</b> . Up to 32 stations can be registered in the speed dial. It will be convenient to register the frequently used destinations.
2	[SPEED DIAL]	Register a destination in the speed dial; you can specify a destination easily and accurately without entering a telephone number using the <b>Keypad</b> . Up to 250 stations can be registered in the speed dial.
3	[GROUP DIAL]	Up to 50 stations can be registered as one group in a single <b>One-Touch Dial Key</b> . It will be convenient to register the group dial when frequently sending the same original to multiple determined destinations.
4	[PROGRAM DIAL]	Register a destination number and sending-receiving function such as the specified-time transmission or polling reception in a <b>One-Touch Dial Key</b> ; you can only press the <b>One-Touch Dial Key</b> to execute the function.



#### Reference

The items above, excluding No.4, can also be configured using LSU (Local Setup Utility). For details, refer to page 11-4.

If an optional **Network Card NC-504** or **Image Controller IC-209** is installed on this machine, settings can also be configured using **PageScope Web Connection**. Items other than No.4 can be configured. For details, refer to **PageScope Web Connection** - [Address] - [One-Touch Dial Setting], [Address] - [Speed Dial Setting], and [Address] - [Group Dial Setting] of [User's Guide Network Administrator].

To register destinations in the user mode of **PageScope Web Connection**, refer to the following.

Check the one-touch dial (p. 8-13)

Check the speed dial (p. 8-13)

Check the group dial (p. 8-14)

## 7.2.2 Registering destinations in the one-touch dial

Register a destination in a **One-Touch Dial Key**; you can specify a destination easily and accurately without entering a telephone number using the **Keypad**.

Up to 32 stations can be registered in the one-touch dial.

Tips

- You can print out a list of destinations registered in **One-Touch Dial Keys**. For details, refer to page 3-21.

- 1 Press the **Utility** key.
- 2 Use **▲▼** to select [DIAL REGISTRATION], and press the **OK** key.
- 3 Use **▲▼** to select [ONE-TOUCH DIAL], and press the **OK** key.
- 4 Press the **One-Touch Dial Key** to register a destination in.
- 5 Use **▲▼** to select [MANUAL SETTING], and press the **OK** key.
  - If the LDAP settings are not configured, this screen does not appear. Go to Step 6.
- 6 Enter the destination name using the **Keypad**, and press the **OK** key.
  - For details on how to enter a character string, refer to [Quick Guide].

→ The destination name can be specified with up to 20 characters.

- 7 Enter a destination fax number using the **Keypad**.
  - A fax number can be specified using up to 30 digits.

- If an optional **Image Controller IC-209** or **Network Card NC-504** is installed on this machine, an E-mail address can be entered into a destination.
- When not specifying the F-code transmission, baud rate, or transmission time, go to Step 10.
- When specifying the F-code transmission, baud rate, or transmission time, press **▼**, and go to the next step.
- For details on the F code such as the SUB address and password, refer to page 4-3.

- 8 Use ▲▼ to select a setting item, and press the **OK** key.
- If [SUB, SID SETTING] is selected: Enter the SUB address and password, and press the **Back** key.
  - The SUB address and password can be specified using up to 20 digits.

```

SUB, SID SETTING
SUB
-----
: 5555
SID
: 98765_

```

- When [MODEM SPEED] is selected: Use ▲▼ to select [33.6Kbps], [14.4Kbps], or [9.6Kbps], and press the **Back** key.
- If [BATCH TIME] is selected: Enter the transmission time using the **Keypad**, and press the **Back** key.

```

BATCH TIME
TIMER 12:3_

```

- Repeat this procedure until all the required settings are completed.

- 9 Select [RETURN], and press the **OK** key.  
This returns to the screen where a fax number can be entered.
- 10 Press **OK**.  
This registers settings, and returns to the Store Address screen.

### 7.2.3 Changing or deleting a one-touch dial destination

- 1 Press the **Utility** key.
- 2 Use ▲▼ to select [DIAL REGISTRATION], and press the **OK** key.
- 3 Use ▲▼ to select [ONE-TOUCH DIAL], and press the **OK** key.
- 4 Press the **One-Touch Dial Key** you want to change or delete.
- 5 Use ▲▼ to select [EDIT] or [DELETE], and press the **OK** key.
  - If [EDIT] is selected, go to the next step.
  - If [DELETE] is selected, the information registered in the **One-Touch Dial Key** is deleted, and the display returns to the Store Address screen.
- 6 Change the destination name, fax number, F code (SUB address or password), or baud rate.  
After all settings are completed, the display returns to the Store Address screen.



#### Reference

For details on how to change each setting, refer to Steps 6 to 8 in page 7-7.



### 7.2.4 Registering destinations in the speed dial

Register a destination in the speed dial; you can specify a destination easily and accurately without entering a fax number using the **Keypad**.

Up to 250 stations (001 to 250) can be registered in the speed dial.

- 1 Press the **Utility** key.
- 2 Use **▲▼** to select [DIAL REGISTRATION], and press the **OK** key.
- 3 Use **▲▼** to select [SPEED DIAL], and press the **OK** key.
- 4 Enter a desired 3-digit speed dial number using the **Keypad**, and press the **OK** key.
  - This displays a speed dial number that is not registered as the default.

```
SPEED DIAL
SPEED DIAL : 011

- PRESS OK KEY -
```

- 5 Use **▲▼** to select [MANUAL SETTING], and press the **OK** key.
  - If the LDAP settings are not configured, this screen does not appear. Go to Step 6.
- 6 Enter the destination name using the **Keypad**, and press the **OK** key.
  - For details on how to enter a character string, refer to [Quick Guide].
  - The destination name can be specified with up to 20 characters.

```
SPEED DIAL 011
NAME
: AAA OSAKA _ [A...]
```

- 7 Enter a destination fax number using the **Keypad**.
  - For details on how to enter a character string, refer to [Quick Guide].
  - A fax number can be specified using up to 30 digits.
  - If an optional **Image Controller IC-209** or **Network Card NC-504** is installed on this machine, an E-mail address can be entered into a destination.

```
SPEED DIAL 011
DESTINATION
: 0123456 _ [1...]

OTHER SETTING =▼
```

- When not specifying the F-code transmission, baud rate, or transmission time, go to Step 10.
- When specifying the F-code transmission or baud rate, press **▼**, and go to the next step.

→ For details on the F code such as the SUB address and password, refer to page 4-3.

- 8 Use ▲▼ to select a setting item, and press the **OK** key.
  - The SUB address and password can be specified using up to 20 digits.
  - If [SUB, SID SETTING] is selected: Enter the SUB address and password, and press the **Back** key.
  - When [MODEM SPEED] is selected: Use ▲▼ to select [33.6Kbps], [14.4Kbps], or [9.6Kbps], and press the **Back** key.
  - Repeat this procedure until all the required settings are completed.
- 9 Select [RETURN], and press the **OK** key.

This returns to the screen where a fax number can be entered.
- 10 Press **OK**.

This registers settings, and returns to the Store Address screen.

### 7.2.5 Changing or deleting a speed dial destination

- 1 Press the **Utility** key.
- 2 Use ▲▼ to select [DIAL REGISTRATION], and press the **OK** key.
- 3 Use ▲▼ to select [SPEED DIAL], and press the **OK** key.
- 4 Enter a target 3-digit speed dial number using the **Keypad**, and press the **OK** key.
- 5 Use ▲▼ to select [EDIT] or [DELETE], and press the **OK** key.
  - If [EDIT] is selected, go to the next step.
  - If [DELETE] is selected, the information registered in the **One-Touch Dial Key** is deleted, and the display returns to the Store Address screen.
- 6 Change the destination name, fax number, F code (SUB address or password), or baud rate.

After all settings are completed, the display returns to the Store Address screen.



#### Reference

*For details on how to change each setting, refer to Steps 6 to 8 in page 7-7.*

### 7.2.6 Registering destinations in the group dial

Up to 50 stations can be registered as one group in a single **One-Touch Dial Key**. It will be convenient to register the group dial when frequently sending the same original to multiple determined destinations.

- 1 Press the **Utility** key.
- 2 Use **▲▼** to select [DIAL REGISTRATION], and press the **OK** key.
- 3 Use **▲▼** to select [GROUP DIAL], and press the **OK** key.
- 4 Press the **One-Touch Dial Key** to register a destination in.
- 5 Enter the group name using the **Keypad**, and press the **OK** key.
  - For details on how to enter a character string, refer to [Quick Guide].
  - The group name can be specified with up to 20 characters.

```
GROUP DIAL 05
NAME
GROUP    5_      [ A ... ]
```

- 6 Use **One-Touch Dial Key** or Speed Dial to specify a destination, and press the **OK** key.

```
GROUP DIAL 05      1/50
DESTINATION
:
-
-OT or SPEED DIAL-
```

- To cancel the currently displayed setting, press the **Clear/Stop** key, and specify the correct value.
- 7 Use **▲▼** to select [ADD], and press the **OK** key.
    - Up to 50 stations can be registered in one group dial.
    - In Group Dial, you can specify a **One-Touch Dial Key** registered as a group dial. In this case, the stations registered in the specified **One-Touch Dial Key** (group dial) are added.
    - Return to Step 6, and specify the next destination.
    - Repeat Steps 6 and 7 until all the destinations are specified.
  - 8 After the specification of all destinations is completed, select [RETURN], and press the **OK** key. This registers settings, and returns to the Store Address screen.

### 7.2.7 Changing or deleting a Group dial destination

- 1 Press the **Utility** key.
- 2 Use **▲▼** to select [DIAL REGISTRATION], and press the **OK** key.
- 3 Use **▲▼** to select [GROUP DIAL], and press the **OK** key.
- 4 Press the **One-Touch Dial Key** you want to change or delete.
- 5 Use **▲▼** to select [EDIT] or [DELETE], and press the **OK** key.
  - If [EDIT] is selected, go to the next step.
  - If [DELETE] is selected, the information registered in the group dial is deleted, and the display returns to the Store Address screen.
- 6 Enter the group name using the **Keypad**, and press the **OK** key.

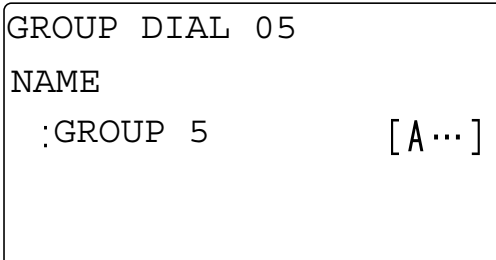

```
GROUP DIAL 05
NAME
:GROUP 5      [A...]
```

- 7 Select [ADD] or [CHECK/EDIT], and press the **OK** key.
  - If [ADD] is selected, go to Step 8.
  - If [CHECK/EDIT] is selected, go to Step 9.
- 8 To add a destination, select [ADD], and press the **OK** key.
  - In the displayed screen, specify a destination using the **One-Touch Dial Key** or Speed Dial.
  - After the addition of a destination is completed, select [RETURN] and press the **OK** key to return to the Store Address screen.
- 9 To check or delete a destination, select [CHECK/EDIT], and press the **OK** key.
  - In the displayed screen, check the currently registered destinations.
  - Pressing the **OK** key displays detailed information of the selected destination.
  - To delete a destination, press the **Clear/Stop** key in the screen to check the destination or display detailed information, and select [YES] in the displayed screen.
  - When deletion is completed, press the **Back** key. In the displayed screen, select [RETURN], and press the **OK** key to return to the Store Address screen.

### 7.2.8 Registering destinations in the program dial

Register a destination number and transmission-receiving function in a **One-Touch Dial Key**; you can only press the **One-Touch Dial Key** to execute the function.

<Transmission and receiving functions that can be registered>

- Sequential broadcast transmission
- Specified-time transmission
- Confidential TX
- Polling RX
- Relay instruction transmission

- 1 Press the **Utility** key.
- 2 Use ▲▼ to select [DIAL REGISTRATION], and press the **OK** key.
- 3 Use ▲▼ to select [PROGRAM DIAL], and press the **OK** key.
- 4 Press a target key among **One-Touch Dial Key 29 to 32**.
  - One-touch dial keys **29 to 32** are available when the **Switching Plate** is opened upward.

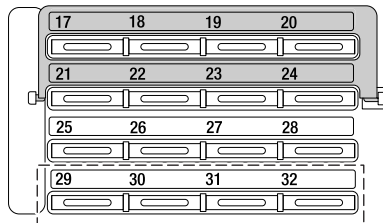

- 5 Use ▲▼ to select a target function, and press the **OK** key.
- 6 Follow the setting procedure for each function.
  - Sequential broadcast transmission (p. 3-15)
  - Specified-time transmission (p. 3-25)
  - Confidential transmission (p. 4-5)
  - Relay instruction transmission (p. 4-11)
  - Polling RX (p. 4-10)
 Settings are registered.
- 7 Use ▲▼ to select [RETURN], and press the **OK** key.
 

This registers settings, and returns to the Store Address screen.

### 7.2.9 Changing or deleting the sequential broadcast transmission program

- 1 Press the **Utility** key.
- 2 Use **▲▼** to select [DIAL REGISTRATION], and press the **OK** key.
- 3 Use **▲▼** to select [PROGRAM DIAL], and press the **OK** key.
- 4 Press the **One-Touch Dial Key** that contains the sequential broadcast transmission program you want to change or delete.
- 5 Use **▲▼** to select [EDIT] or [DELETE], and press the **OK** key.
  - If [EDIT] is selected, go to the next step.
  - If [DELETE] is selected, the information registered in the program dial is deleted, and the display returns to the Store Address screen.
- 6 Use **▲▼** to select [ADD] or [CHECK/EDIT], and press the **OK** key.
  - If [ADD] is selected, enter a destination, and press the **OK** key.
  - If [CHECK/EDIT] is selected, go to the next step.
- 7 Use **▲▼** to select a target destination, and press the **OK** key.
  - To delete the displayed destination, press the **Clear/Stop** key, and select [YES] in the displayed screen.
  - Repeat this procedure until checking and correcting a destination is completed. After this, press the **Back** key.
- 8 Select [RETURN], and press the **OK** key.

This registers settings, and returns to the Store Address screen.

### 7.2.10 Changing or deleting the specified-time transmission program

- 1 Press the **Utility** key.
- 2 Use **▲▼** to select [DIAL REGISTRATION], and press the **OK** key.
- 3 Use **▲▼** to select [PROGRAM DIAL], and press the **OK** key.
- 4 Press the **One-Touch Dial Key** that contains the specified-time transmission program you want to change or delete.
- 5 Use **▲▼** to select [EDIT] or [DELETE], and press the **OK** key.
  - If [EDIT] is selected, go to the next step.
  - If [DELETE] is selected, the information registered in the program dial is deleted, and the display returns to the Store Address screen.
- 6 Enter the transmission time using the **Keypad**, and press the **OK** key.

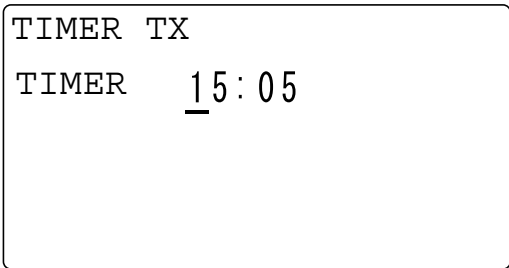

TIMER TX  
TIMER 15:05

- 7 Change the destination setting as necessary, and press the **OK** key.

This registers settings, and returns to the Store Address screen.

### 7.2.11 Changing or deleting the confidential transmission program

- 1 Press the **Utility** key.
- 2 Use **▲▼** to select [DIAL REGISTRATION], and press the **OK** key.
- 3 Use **▲▼** to select [PROGRAM DIAL], and press the **OK** key.
- 4 Press the **One-Touch Dial Key** that contains the confidential transmission program you want to change or delete.
- 5 Use **▲▼** to select [EDIT] or [DELETE], and press the **OK** key.
  - If [EDIT] is selected, go to the next step.
  - If [DELETE] is selected, the information registered in the program dial is deleted, and the display returns to the Store Address screen.
- 6 When necessary, use the **One-Touch Dial Key**, Speed Dial, or Keypad to specify a destination, and press the **OK** key.

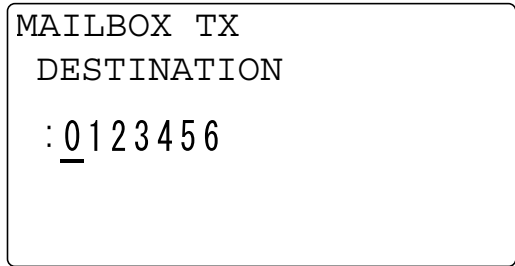

MAILBOX TX  
DESTINATION  
: 0123456

- 7 If necessary, change the Confidential User Box ID or password using the **Keypad**, and press the **OK** key.  
This registers settings, and returns to the Store Address screen.

### 7.2.12 Changing or deleting the polling RX program

- 1 Press the **Utility** key.
- 2 Use **▲▼** to select [DIAL REGISTRATION], and press the **OK** key.
- 3 Use **▲▼** to select [PROGRAM DIAL], and press the **OK** key.
- 4 Press the **One-Touch Dial Key** that contains the polling RX program you want to change or delete.
- 5 Use **▲▼** to select [EDIT] or [DELETE], and press the **OK** key.
  - If [EDIT] is selected, go to the next step.
  - If [DELETE] is selected, the information registered in the program dial is deleted, and the display returns to the Store Address screen.
- 6 Use **▲▼** to select [ADD] or [CHECK/EDIT], and press the **OK** key.
  - If [ADD] is selected, enter a destination, and press the **OK** key.
  - If [CHECK/EDIT] is selected, go to the next step.
- 7 Use **▲▼** to select a target destination, and press the **OK** key.
  - To delete the displayed destination, press the **Clear/Stop** key, and select [YES] in the displayed screen.
  - Repeat this procedure until checking and correcting a destination is completed. After this, press the **Back** key.
- 8 Select [RETURN], and press the **OK** key.  
This registers settings, and returns to the Store Address screen.

### 7.2.13 Changing or deleting the relay instruction transmission program

- 1 Press the **Utility** key.
- 2 Use **▲▼** to select [DIAL REGISTRATION], and press the **OK** key.
- 3 Use **▲▼** to select [PROGRAM DIAL], and press the **OK** key.
- 4 Press the **One-Touch Dial Key** that contains the relay instruction transmission program you want to change or delete.
- 5 Use **▲▼** to select [EDIT] or [DELETE], and press the **OK** key.
  - If [EDIT] is selected, go to the next step.
  - If [DELETE] is selected, the information registered in the program dial is deleted, and the display returns to the Store Address screen.
- 6 When necessary, use the **One-Touch Dial Key**, Speed Dial, or Keypad to specify a destination, and press the **OK** key.

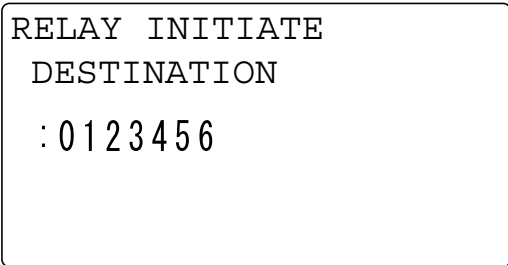

```
RELAY INITIATE
DESTINATION
: 0123456
```

- 7 If necessary, change the Relay User Box ID or password using the **Keypad**, and press the **OK** key. This registers settings, and returns to the Store Address screen.



## 7.3 Fax registration

This section explains registration items that are available for efficiently using the fax functions of this machine.

### 7.3.1 Fax registration items

No.	Fax registration	Contents
1	[MAIL BOX]	Specify the Confidential User Box ID to use confidential RX or polling TX. The confidential RX or polling TX is performed when the destination side uses the User Box ID specified in this item.
2	[RELAY BOX]	Specify the Relay User Box ID to use this machine as a relay distribution station. When the sender specifies the User Box ID specified in this item, this machine receives the original from the sender once, and sends it to a destination (receiving station).

### 7.3.2 Registering the Confidential User Box

To use the confidential RX, which saves received data in the Confidential User Box only when the User Box ID specified on this machine matches that sent from the sender, specify the User Box ID in advance.

Tips

- The same value cannot be registered between the Relay User Box ID and Confidential User Box ID.

- 1 Press the **Utility** key.
- 2 Use **▲▼** to select [FAX REGISTRATION], and press the **OK** key.
- 3 Use **▲▼** to select [MAILBOX], and press the **OK** key.
- 4 Enter a Confidential User Box number using the **Keypad**, and press the **OK** key.
  - For Confidential User Box number, specify a numeric value between 1 and 5.

MAILBOX

NO : \_ (1-5)

- 5 Enter a 4-digit User Box ID using the **Keypad**, and press the **OK** key.
  - For User Box ID, specify a numeric value between 0000 and 9999.
  - To correct a User Box ID, press the **Clear/Stop** key.

- 6 Enter a 4-digit password using the **Keypad**, and press the **OK** key.

```
MAILBOX
MAILBOX 5 ID
: 0123
PASSWORD
: 5678
```

- For password, specify a numeric value between 0000 and 9999.
- To correct a password, press the **Clear/Stop** key.
- When not registering a password, press the **OK** key without entering any digits. This returns to the fax registration screen.

### 7.3.3 Deleting the Confidential User Box setting

- 1 Press the **Utility** key.
- 2 Use **▲▼** to select [FAX REGISTRATION], and press the **OK** key.
- 3 Use **▲▼** to select [MAILBOX], and press the **OK** key.
- 4 Enter a target Confidential User Box number using the **Keypad**, and press the **OK** key.
- 5 Select [DELETE], and press the **OK** key.
- 6 Enter a registered 4-digit User Box ID using the **Keypad**, and press the **OK** key.

```
MAILBOX
MAILBOX 5 ID
: 0123
```

- To correct a numeric value, press the **Clear/Stop** key. This returns to the fax registration screen.

### 7.3.4 Registering the Relay User Box

When this machine receives an original sent from other fax machine (relay instruction station) as a relay distribution station and sends the original to multiple destinations (receiving stations), specify the Relay User Box ID and other items in advance.

#### Tips

- The same value cannot be registered between the Relay User Box ID and Confidential User Box ID.
- When necessary, you can specify that a relay result report is returned from this machine (relay distribution station) to a destination. For a return destination, specify a fax number of a relay instruction station or other sender using the **One-Touch Dial Key**, Speed Dial, or Keypad. To specify a destination using a **One-Touch Dial Key** or speed dial number, register a fax number of a return destination in a **One-Touch Dial Key** or speed dial number in advance.

- 1 Press the **Utility** key.
- 2 Use **▲▼** to select [FAX REGISTRATION], and press the **OK** key.
- 3 Use **▲▼** to select [RELAY BOX], and press the **OK** key.
- 4 Enter a Relay User Box number using the **Keypad**, and press the **OK** key.
  - For Relay User Box number, specify a numeric value between 0 and 9.

```
RELAY BOX
NO : _ (0-9)
```

- 5 Enter a 4-digit User Box ID using the **Keypad**, and press the **OK** key.
  - For User Box ID, specify a numeric value between 0000 and 9999.
  - To correct a User Box ID, press the **Clear/Stop** key.
- 6 Enter a 4-digit password using the **Keypad**, and press the **OK** key.

```
RELAY BOX
RELAY BOX 5 ID
: 0123
PASSWORD
: 5678
```

- For password, specify a numeric value between 0000 and 9999.
  - To correct a password, press the **Clear/Stop** key.
  - When not registering a password, press the **OK** key without entering any digits.
- 7 To return a relay result report, select [REPORT], and press the **OK** key.
    - When not returning a report, skip to Step 9.

- 8 Use the **One-Touch Dial Key**, Speed Dial, or Keypad to specify a return destination, and press the **OK** key.

```
RELAY BOX 5
DESTINATION
SPEED DIAL :011
-PRESS OK KEY-
```

- 9 Select [DESTINATION], and press the **OK** key.
- 10 Use a **One-Touch Dial Key** or speed dial to specify a receiving station, and press the **OK** key.

```
RELAY BOX 5          1/50
DESTINATION
:AAA KYOTO
7654321
```

→ To continuously specify a destination, select [ADD] in the next displayed screen, and repeat this procedure.

- 11 After the specification of all receiving stations is completed, select [RETURN], and press the **OK** key. This returns to the fax registration screen.

### 7.3.5 Deleting the Relay User Box setting

- 1 Press the **Utility** key.
- 2 Use **▲▼** to select [FAX REGISTRATION], and press the **OK** key.
- 3 Use **▲▼** to select [RELAY BOX], and press the **OK** key.
- 4 Enter a target Relay User Box number using the **Keypad**, and press the **OK** key.

```
RELAY BOX
NO : 5 (0-9)
```

- 5 Select [DELETE], and press the **OK** key. This returns to the fax registration screen.

## 7.4 Fax TX setting

Configure various transmission settings for fax communication.

### 7.4.1 Fax TX setting items

No.	Fax TX setting	Contents
1	[DENSITY LEVEL]	Select the default density to scan the original from five levels. When the paper color (background color) is darker, adjust to the light side. When a text is faint or colored, adjust to the dark side.
2	[QUALITY PRIORITY]	Specify the default image quality (resolution) to scan the original with a combination of [STD/TEXT], [FINE/TEXT], [S-FINE/TEXT], [STD/PHOTO], [FINE/PHOTO], and [S-FINE/PHOTO]. <ul style="list-style-type: none"> <li>The factory default is [STD/TEXT].</li> </ul>
3	[DEFAULT TX]	Select the default transmission method from [MEMORY TX] and [ADF TX]. <ul style="list-style-type: none"> <li>The factory default is [MEMORY TX].</li> </ul> <b>Tips</b> This setting is displayed when optional <b>Reverse Automatic Document Feeder DF-625</b> is installed.
4	[HEADER]	To specify whether to add a header (transmission date and time, sender name, sender's fax number, and other items) when transmitting a fax, select [ON] or [OFF] as the default. <ul style="list-style-type: none"> <li>The factory default is [ON].</li> </ul> <b>Tips</b> This setting item may not be displayed in some regions.
5	[CONFIRM FAX NO.]	When specifying a fax destination with direct input, a screen appears prompting you to enter the fax number again for confirmation. Entering the fax number twice prevents one from entering incorrect destinations. Select [ON] or [OFF] as needed. <ul style="list-style-type: none"> <li>The factory default is [OFF].</li> </ul>



#### Reference

*Fax TX settings can also be configured using LSU (Local Setup Utility). For details, refer to page 11-4.*

*If an optional **Image Controller IC-209** or **Network Card NC-504** is installed on this machine, settings can also be configured using **PageScope Web Connection**. For details, refer to **PageScope Web Connection - [Address] - [Fax Configuration]** of *[User's Guide Network Administrator]*.*

### 7.4.2 Specifying the scanning density

- 1 Press the **Utility** key.
- 2 Use **▲▼** to select [FAX TX OPERATION], and press the **OK** key.
- 3 Use **▲▼** to select [DENSITY LEVEL], and press the **OK** key.
- 4 Use **◀▶** to select the density, and press the **OK** key.  
This returns to the fax TX settings screen.

### 7.4.3 Specifying the quality priority

- 1 Press the **Utility** key.
- 2 Use **▲▼** to select [FAX TX OPERATION], and press the **OK** key.
- 3 Use **▲▼** to select [QUALITY PRIORITY], and press the **OK** key.
- 4 Use **▲▼** to select a target image quality, and press the **OK** key.  
This returns to the fax TX settings screen.

### 7.4.4 Specifying the default TX mode

#### Tips

This setting item may not be displayed in some regions.

- 1 Press the **Utility** key.
- 2 Use **▲▼** to select [FAX TX OPERATION], and press the **OK** key.
- 3 Use **▲▼** to select [DEFAULT TX], and press the **OK** key.
- 4 Use **▲▼** to select [MEMORY TX] or [ADF TX], and press the **OK** key.  
This returns to the fax TX settings screen.

### 7.4.5 Configuring header printing

#### Tips

This setting item may not be displayed in some regions.

- 1 Press the **Utility** key.
- 2 Use **▲▼** to select [FAX TX OPERATION], and press the **OK** key.
- 3 Use **▲▼** to select [HEADER], and press the **OK** key.
- 4 Use **▲▼** to select [OFF] or [ON], and press the **OK** key.  
This returns to the fax TX settings screen.

### 7.4.6 Configuring the fax number confirmation function

- 1 Press the **Utility** key.
- 2 Use **▲▼** to select [FAX TX OPERATION], and press the **OK** key.
- 3 Use **▲▼** to select [CONFIRM FAX NO.], and press the **OK** key.
- 4 Use **▲▼** to select [OFF] or [ON], and press the **OK** key.  
This returns to the fax TX settings screen.

## 7.5 Fax RX setting

Configure various receiving settings for fax communication.

### 7.5.1 Fax RX setting items

No.	Fax RX setting	Contents
1	[MEMORY RX MODE]	Select [ON] or [OFF] for memory RX. If you have received a confidential document, you can save it in the memory once, and print out it at the specified time or when the memory RX mode is set to [OFF]. Specify the memory RX starting and ending times as well as the password to cancel memory RX. The specified starting and ending times are available every day until the memory RX mode is released. <ul style="list-style-type: none"> <li>The factory default is [OFF].</li> </ul>
2	[NO. of RINGS]	Select the number of rings used for auto RX between 1 and 16.
3	[REDUCTION RX]	Select [ON] to reduce, [OFF] to split, or [CUT] to cut a longer document than the print paper size. Specifying [CUT] cuts maximum 1 inch (24 mm). However, if a long text of 1 inch (24 mm) or more is sent, the [CUT] setting is not applied. In this case, the document is split into parts. <ul style="list-style-type: none"> <li>The factory default is [ON].</li> </ul>
4	[RX PRINT]	Select [MEMORY RX] to start printing after all the original pages have been received, or [PRINT RX] to start printing when the first original page has been received. <ul style="list-style-type: none"> <li>The factory default is [MEMORY RX].</li> </ul>
5	[RX MODE]	Select auto RX or manual RX. [ <b>AUTO RX</b> ]: Starts receiving data automatically after rings have sounded by the specified number of times. [ <b>MANUAL RX</b> ]: Does not switch to the fax mode automatically when the phone rings. Pick up the phone receiver of the external telephone or press the <b>On Hook</b> key to connect the line. Then, press the <b>Start</b> key to start the receiving operation. <ul style="list-style-type: none"> <li>The factory default is [AUTO RX].</li> </ul>
6	[FORWARD]	Select whether to forward the received original. [ON]: Forwards the received original to the specified fax number or E-mail address. [ON (PRINT)]: Forwards the received original to a specified fax number or E-mail address, and also prints it out on this machine. [OFF]: Does not forward the received original. <ul style="list-style-type: none"> <li>The factory default is [OFF].</li> </ul> * To forward to an E-mail address, you need to install an optional <b>Image Controller IC-209</b> or <b>Network Card NC-504</b> in advance.
7	[FOOTER]	Select whether to print receiving information (receiving date and time, number of pages, and other items) in the footer area of the received original. <ul style="list-style-type: none"> <li>The factory default is [OFF].</li> </ul>
8	[SELECT TRAY]	Select a paper tray when printing the received original or communication report. (You can specify a tray to prohibit paper feeding.) <ul style="list-style-type: none"> <li>The factory default is [ENABLE].</li> </ul>
9	[CLOSED NETWORK]	Select whether to receive a fax when the fax number of the sender does not match that registered in the one-touch dial or speed dial of this machine. If it is set to [ON], only faxes from the registered fax numbers will be received, and this can reject unwanted faxes. <ul style="list-style-type: none"> <li>The factory default is [OFF].</li> </ul>

## 7.5.2 Specifying the memory RX mode

- 1 Press the **Utility** key.
- 2 Use **▲▼** to select [FAX RX OPERATION], and press the **OK** key.
- 3 Use **▲▼** to select [MEMORY RX MODE], and press the **OK** key.
- 4 Use **▲▼** to select [ON], and press the **OK** key.
- 5 Enter the starting time using the **Keypad**, and press the **OK** key.
- 6 Enter the ending time using the **Keypad**, and press the **OK** key.
- 7 Enter a 4-digit password using the **Keypad**, and press the **OK** key.

```
MEMORY RX MODE
ON TIME      18:00
OFF TIME     21:00
PASSWORD     1234
```

→ When not registering a password, press the **OK** key without entering any digits.  
This returns to the fax RX settings screen.

## 7.5.3 Releasing the memory RX mode

The memory RX mode is released automatically at the ending time, and the received original is printed out. If the ending time is not specified or if you want to release the memory RX mode before the ending time, follow the steps shown below.

- 1 Press the **Utility** key.
- 2 Use **▲▼** to select [FAX RX OPERATION], and press the **OK** key.
- 3 Use **▲▼** to select [MEMORY RX MODE], and press the **OK** key.
- 4 Use **▲▼** to select [OFF], and press the **OK** key.
  - If a password is specified, go to the next step.
  - If a password is not specified, the received original in the memory is printed out, and the display returns to the fax RX settings menu.
- 5 Enter a 4-digit password using the **Keypad**, and press the **OK** key.

```
MEMORY RX MODE
PASSWORD : 1234
```

This returns to the fax RX settings screen.



### 7.5.4 Specifying the number of rings

- 1 Press the **Utility** key.
- 2 Use **▲▼** to select [FAX RX OPERATION], and press the **OK** key.
- 3 Use **▲▼** to select [NO. of RINGS], and press the **OK** key.
- 4 Enter the number of rings using the **Keypad**, and press the **OK** key.  
→ For the number of rings, specify a numeric value between 1 and 16.

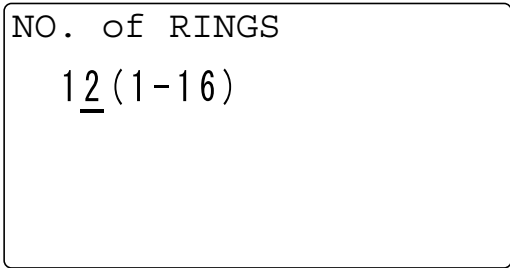

NO. of RINGS  
12 (1-16)

This returns to the fax RX settings screen.

### 7.5.5 Configuring the print reduction

- 1 Press the **Utility** key.
- 2 Use **▲▼** to select [FAX RX OPERATION], and press the **OK** key.
- 3 Use **▲▼** to select [REDUCTION RX], and press the **OK** key.
- 4 Use **▲▼** to select [OFF], [ON], or [CUT], and press the **OK** key.  
This returns to the fax RX settings screen.

### 7.5.6 Configuring the RX printing

- 1 Press the **Utility** key.
- 2 Use **▲▼** to select [FAX RX OPERATION], and press the **OK** key.
- 3 Use **▲▼** to select [RX PRINT], and press the **OK** key.
- 4 Use **▲▼** to select [MEMORY RX] or [PRINT RX], and press the **OK** key.  
This returns to the fax RX settings screen.

### 7.5.7 Configuring the RX mode

- 1 Press the **Utility** key.
- 2 Use **▲▼** to select [FAX RX OPERATION], and press the **OK** key.
- 3 Use **▲▼** to select [RX MODE], and press the **OK** key.
- 4 Use **▲▼** to select [AUTO RX] or [MANUAL RX], and press the **OK** key.  
This returns to the fax RX settings screen.

### 7.5.8 Configuring the forward mode

- 1 Press the **Utility** key.
- 2 Use **▲▼** to select [FAX RX OPERATION], and press the **OK** key.
- 3 Use **▲▼** to select [FORWARD], and press the **OK** key.
- 4 Use **▲▼** to select [OFF], [ON], or [ON (PRINT)], and press the **OK** key.
  - If [ON] or [ON (PRINT)] is selected, go to Step 5.
  - If [OFF] is selected, the display returns to the fax RX settings menu.
- 5 Use the **One-Touch Dial Key**, speed dial, or **Keypad** to specify a fax number of a forward destination, and press the **OK** key.

FORWARD	
DESTINATION	
: 0 1 2 3 4 5 6 _	[ 1 ... ]
SUB, SID SETTING = <b>▼</b>	

- If an optional **Image Controller IC-209** or **Network Card NC-504** is installed on this machine, an E-mail address can be specified as a forward destination. For details, refer to **PageScope Web Connection** - [Address] - [Fax Configuration] of [User's Guide Network Administrator].  
This returns to the fax RX settings screen.

### 7.5.9 Configuring footer printing

- 1 Press the **Utility** key.
- 2 Use **▲▼** to select [FAX RX OPERATION], and press the **OK** key.
- 3 Use **▲▼** to select [FOOTER], and press the **OK** key.
- 4 Use **▲▼** to select [OFF] or [ON], and press the **OK** key.  
This returns to the fax RX settings screen.

### 7.5.10 Selecting a tray

- 1 Press the **Utility** key.
- 2 Use **▲▼** to select [FAX RX OPERATION], and press the **OK** key.
- 3 Use **▲▼** to select [SELECT TRAY], and press the **OK** key.
- 4 Use **▲▼** to select a target tray, and press the **OK** key.
- 5 Use **▲▼** to select [DISABLE] or [ENABLE], and press the **OK** key.  
This returns to the fax RX settings screen.

### 7.5.11 Configuring the closed network

- 1 Press the **Utility** key.
- 2 Use **▲▼** to select [FAX RX OPERATION], and press the **OK** key.
- 3 Use **▲▼** to select [CLOSED NETWORK], and press the **OK** key.
- 4 Use **▲▼** to select [OFF] or [ON], and press the **OK** key.  
This returns to the fax RX settings screen.

## 7.6 Report setting

Configure settings to automatically print out various reports for fax communication.

### 7.6.1 Report setting items

No.	Report setting	Contents
1	[ACTIVITY REPORT]	Prints out the sending and receiving result as a report every 60 communications. Select whether to print out a report automatically when 60 communications are reached. <ul style="list-style-type: none"> <li>The factory default is [ON].</li> </ul>
2	[RESERVATION REPORT]	Prints out the reserved information as a report when you establish communications with multiple destinations by sequential broadcast transmission or polling RX. Select whether to automatically print out a report. <ul style="list-style-type: none"> <li>The factory default is [OFF].</li> </ul>
3	[TX RESULT REPORT]	Prints out the transmission result as a report after a transmission has been completed. Select whether to automatically print out a report. <ul style="list-style-type: none"> <li>The factory default is [OFF].</li> </ul>
4	[RX RESULT REPORT]	Select whether to print out a report automatically after a confidential reception has been completed. (If a normal reception has not been completed properly, a report is output regardless of this setting.) <ul style="list-style-type: none"> <li>The factory default is [OFF].</li> </ul>



#### Reference

*Report settings can also be configured using LSU (Local Setup Utility). For details, refer to page 11-4.*

*If an optional **Image Controller IC-209** or **Network Card NC-504** is installed on this machine, settings can also be configured using **PageScope Web Connection**. For details, refer to **PageScope Web Connection - [Address] - [Fax Configuration]** of **[User's Guide Network Administrator]**.*

### 7.6.2 Selecting whether to automatically print out a Activity Report

- 1 Press the **Utility** key.
- 2 Use **▲▼** to select [REPORTING], and press the **OK** key.
- 3 Use **▲▼** to select [ACTIVITY REPORT], and press the **OK** key.
- 4 Use **▲▼** to select [OFF] or [ON], and press the **OK** key.  
This returns to the report settings screen.

### 7.6.3 Selecting whether to automatically print out a reservation report

- 1 Press the **Utility** key.
- 2 Use **▲▼** to select [REPORTING], and press the **OK** key.
- 3 Use **▲▼** to select [RESERVATION REPORT], and press the **OK** key.
- 4 Use **▲▼** to select [OFF] or [ON], and press the **OK** key.  
This returns to the report settings screen.

#### 7.6.4 Selecting whether to automatically print out a transmission result report

- 1 Press the **Utility** key.
- 2 Use **▲▼** to select [REPORTING], and press the **OK** key.
- 3 Use **▲▼** to select [TX RESULT REPORT], and press the **OK** key.
- 4 Use **▲▼** to select [OFF] or [ON], and press the **OK** key.  
This returns to the report settings screen.

#### 7.6.5 Selecting whether to automatically print out a receiving result report

- 1 Press the **Utility** key.
- 2 Use **▲▼** to select [REPORTING], and press the **OK** key.
- 3 Use **▲▼** to select [RX RESULT REPORT], and press the **OK** key.
- 4 Use **▲▼** to select [OFF] or [ON], and press the **OK** key.  
This returns to the report settings screen.





## **PageScope Web Connection**





## 8 PageScope Web Connection

### 8.1 Overview

**PageScope Web Connection** is a device control utility that is built into the printer controller of this machine. This utility can be used as an interface to control the machine remotely via the Web browser.

Tips

- To use **PageScope Web Connection**, **Network Card NC-504** or **Image Controller IC-209** must be installed on the machine.

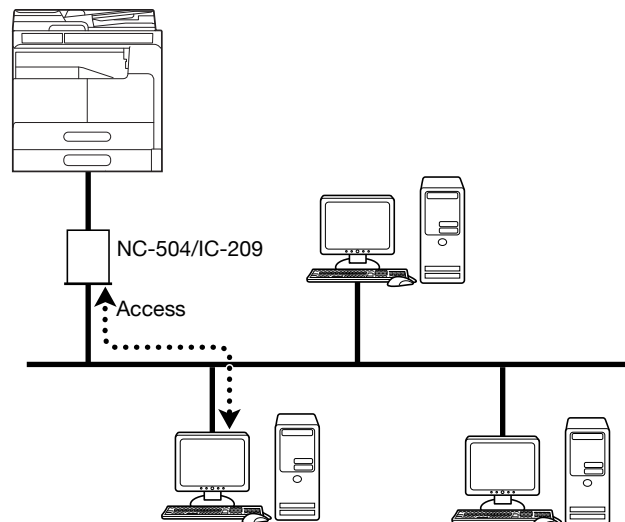

You can use **PageScope Web Connection** to perform the following tasks:

- Changing the settings
  - Registering the destination telephone numbers
  - Changing the printer settings
  - Changing the network settings
- Controlling the status remotely
  - Checking the tray, consumables, and total counter information
  - Checking print jobs (that can be deleted in administrator mode)
- Maintenance
  - Resetting both the **Network Card** and **Image Controller**
  - Initializing the **Network Card** and **Image Controller** to the factory default

#### 8.1.1 Operating environments

Network	Ethernet (TCP/IP)
Operating systems	Windows Vista/7/8/8.1/Server 2008/ Server 2008 R2/Server 2012/Server 2012 R2
Compatible Web browsers	Microsoft Internet Explorer 7 or later Mozilla Firefox 3.5/3.6 or later

## 8.2 How to use PageScope Web Connection

### 8.2.1 How to access

**PageScope Web Connection** can be accessed directly from the Web browser.

- 1 Start the Web browser.
- 2 Enter the IP address of this machine in the URL field as shown below, then press the Enter key.
  - http://<IP address for the machine>/
  - Example: When the IP address for the machine is 192.168.1.20  
http://192.168.1.20/

Tips

- To access **PageScope Web Connection**, an IP address must be assigned to the machine.

### 8.2.2 How to view the screen

When you access **PageScope Web Connection**, the following screen appears.

Tips

- Screen images included in this document may differ from actual view. Note that the product specification is subject to change without notice.

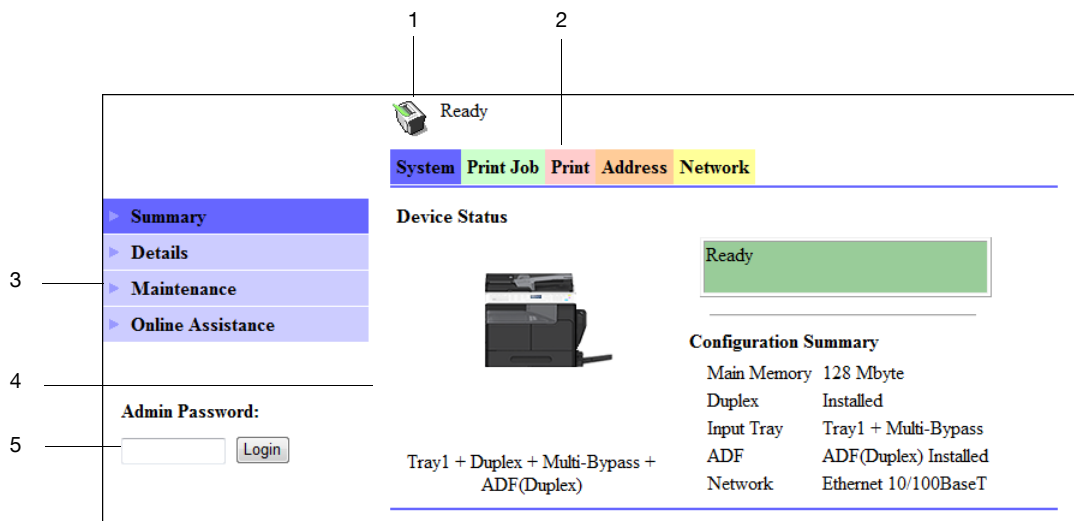

No.	Item	Description
1	Status display	The status of the machine is indicated by an icon and a message.
2	Tabs	Select the category of the item to be displayed. The following tabs are displayed in user mode. <ul style="list-style-type: none"> <li>• System</li> <li>• Print Job</li> <li>• Print</li> <li>• Address</li> <li>• Network</li> </ul>
3	Menu	Displays information and settings for the selected tab. The menu that appears in this area varies depending on which tab was selected.
4	Information and settings	Displays the details of the item selected in the menu.
5	Administrator Password	Enter the password to log into administrator mode.

## Tips

- The [Print] tab is displayed only when **Image Controller IC-209** is installed.
- The contents of the **PageScope Web Connection** pages vary depending on the options installed on this machine or the settings of this machine.

### 8.2.3 User mode and administrator mode

**PageScope Web Connection** provides the user mode and administrator mode.

## User mode

- This mode is available for all users. Only items that can be checked or operated on the user level are displayed in this mode.

## Administrator mode

- This mode is only available for administrators. Almost all items that can be configured or checked in **PageScope Web Connection** are displayed in this mode. Settings of each item can also be changed.

The screen first appears when you access **PageScope Web Connection** is for user mode.

To change the mode into administrator mode, enter the administrator password in the [Admin Password], then click [Login].

**Reference**

*For details on the administrator mode, refer to the [User's Guide Network Administrator].*

### 8.2.4 How to operate

To operate **PageScope Web Connection**, click a tab to select a category of the desired function, then click the menu item to display the settings.

If the selected item is for view only, check the content in the area displaying the information and settings.

If the selected item is available for editing, edit the settings in the information and setting view.

To change the settings, click each tab and configure the necessary settings, then click [Apply]. The method to change settings may differ depending on the selected item. For details, refer to the page explaining the item.

**PageScope Web Connection** can be operated just like Internet Web pages. You can click a link in an Web page to jump to the destination, or click [Back] or [Forward] in the Web browser to view the previous or next page.

## 8.3 User mode

This section describes the usage for each menu item that is displayed at the left-hand side when you click a tab in user mode.

For details on the administrator mode, refer to the [User's Guide Network Administrator].

### 8.3.1 [System] - [Summary]

This item displays the system configuration and status of the machine. This view first appears when you access **PageScope Web Connection** from the Web browser.

Ready

System Print Job Print Address Network

Summary  
Details  
Maintenance  
Online Assistance

Admin Password:  Login

Device Status

Ready

Tray1 + Duplex + Multi-Bypass + ADF(Duplex)

Configuration Summary

Main Memory	128 Mbyte
Duplex	Installed
Input Tray	Tray1 + Multi-Bypass
ADF	ADF(Duplex) Installed
Network	Ethernet 10/100BaseT

### 8.3.2 [System] - [Details]

You can check paper tray, output tray, ROM version, and interface information, as well as the status of consumables.

Ready

System Print Job Print Address Network

Summary  
Details  
Input Tray  
Output Tray  
ROM Version  
Interface Information  
Consumable  
Maintenance  
Online Assistance

Admin Password:  Login

Input Tray

Tray	Paper Size	Media Type	Orientation	Capacity	Status
Tray1	A4	Plain	Shortedge	250	Ready
Multi-Bypass	A4	Plain	Longedge	100	Empty

Item	Description
[Input Tray]	Displays the installed tray names, paper size, paper type, orientation, the maximum capacity and status of each tray.

Item	Description
[Output Tray]	Displays the installed output tray names, the maximum capacity and status of each tray.
[ROM Version]	Displays the installed controller and its ROM version.
[Interface Information]	Displays the installed interfaces and its information.
[Consumable]	Displays information about consumables relevant to the machine.

#### Tips

- The items displayed may vary depending on options installed or settings.

### 8.3.3 [System] - [Maintenance] - [Counter]

Enables you to check the count information that is managed on this machine.

 Ready

System
Print Job
Print
Address
Network

---

- ▶ Summary
- ▶ Details
- ▼ Maintenance
  - ▶ Counter
  - ▶ Power Save Setting
  - ▶ Online Assistance

**Counter**

Total Count	003647
Duplex Total Count	000420
Paper Size Count	000328

---

**Admin Password:**

### 8.3.4 [System] - [Maintenance] - [Power Save Setting]

Configure the settings related to transition to the Power Save mode.

Ready

System Print Job Print Address Network

Summary  
Details  
Maintenance  
Counter  
Power Save Setting  
Online Assistance

Power Save Setting

Sleep Time 240 minute (1-240)

Enter Power Save Mode Normal

Apply Clear

Admin Password:  
 Login

Configure the settings and click [Apply] to apply the change.

Item	Description
[Sleep Time]	Enter a time interval before the machine transitions to the Power Save mode after the last operation.
[Enter Power Save Mode]	Specify how the machine should enter the Power Save mode after printing out a received document. Setting this item to [Immediately] returns the machine to the Power Save mode immediately after receiving and outputting a print job while it is not being used (in the night for example), and thereby saves the electric power mode efficiently. If [Normal] is selected, the machine returns to the Power Save mode according to the [Sleep Time] setting.

### 8.3.5 [System] - [Online Assistance]

This item displays the online assistance about this product.

Ready

System Print Job Print Address Network

Summary  
Details  
Maintenance  
Online Assistance

Online Assistance

Contact KONICA MINOLTA Customer Support

Contact Tel Number

Product Help URL <http://pagescope.com>

Corporate URL <http://konicaminolta.com>

Tel Number for Supplies / Accessories

Admin Password:  
 Login

### 8.3.6 [Print Job] - [Print Job Management]

This item enables you to check details on print jobs.

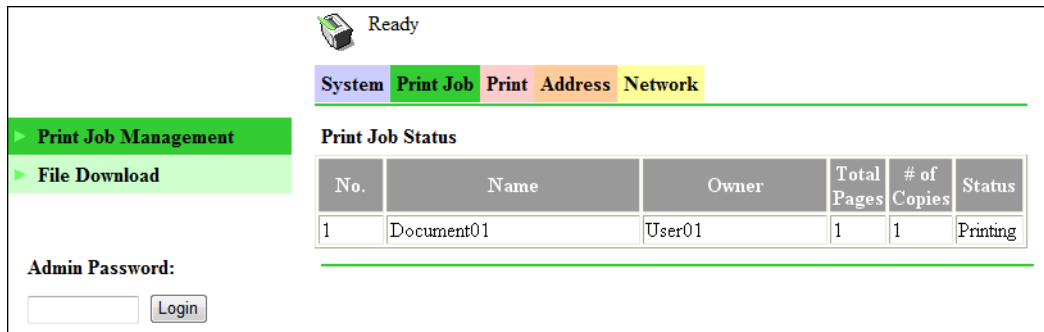

Ready

System **Print Job** Print Address Network

Print Job Management

File Download

Admin Password:  Login

Print Job Status

No.	Name	Owner	Total Pages	# of Copies	Status
1	Document01	User01	1	1	Printing

#### Tips

- Up to 20 print jobs can be displayed. Completed print jobs are deleted automatically.
- Jobs specified as secure print are not displayed.
- The job number displayed here was assigned when the job was registered with the machine.
- To delete a print job, you must log into administrator mode.

### 8.3.7 [Print Job] - [File Download]

A PRN file created with the printer driver of this machine can be downloaded on to the machine and printed.

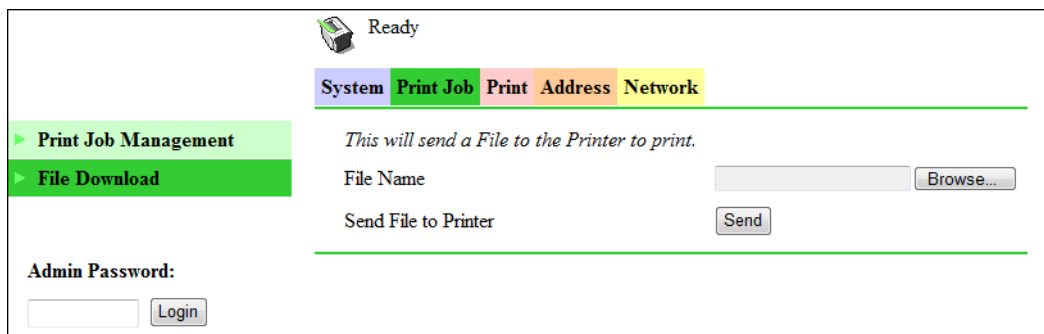

Ready

System **Print Job** Print Address Network

Print Job Management

File Download

Admin Password:  Login

*This will send a File to the Printer to print.*

File Name  Browse...

Send File to Printer

1 Click [Browse] and select a file.

2 Click [Send].

The file is downloaded on to the machine and printed.

#### Tips

- The following formats can be downloaded and printed depending on the option installation status.
  - No option: GDI and XPS PRN files
  - When **Image Controller IC-209** is installed: PCL and XPS PRN files, and ASCII text files
- If a file other than the above is downloaded, the characters will become garbled and will not print correctly.

### 8.3.8 [Print] - [Settings] - [Paper Handling]

This item enables you to check the settings relevant to the printer output.

If a print job is received with no settings configured, the job is printed in this setting.

The screenshot shows a printer control panel with a 'Ready' status and a navigation bar with tabs: System, Print Job, Print, Address, and Network. The 'Print' tab is active. On the left, a settings menu is expanded to 'Paper Handling'. The main area displays 'Paper Handling' settings: 'Copies' is set to 1 (range 1-999), 'Paper Source' is set to Auto, and 'Media Path' is set to simplex. At the bottom, there is an 'Admin Password:' field with a 'Login' button.

Item	Description
[Copies]	Displays the specified number of copies.
[Paper Source]	Displays the selected paper tray.
[Media Path]	Displays the selected printing method.

Tips

- The [Print] tab is displayed only when **Image Controller IC-209** is installed.

### 8.3.9 [Print] - [Settings] - [Page Layout]

This item enables you to check the paper size specified for the output paper size of the printer.

If a print job is received with no settings configured, the job is printed in this setting.

The screenshot shows the same printer control panel as in 8.3.8, but with the 'Page Layout' tab selected in the settings menu. The main area displays 'Page Layout' settings: 'Paper Size' is set to A4. The 'Admin Password:' field and 'Login' button are also visible at the bottom.

Tips

- The [Print] tab is displayed only when **Image Controller IC-209** is installed.



### 8.3.10 [Print] - [Settings] - [Printer Setting]

This item enables you to check the settings relevant to the PCL function of the printer.

If a print job is received with no settings configured, the job is printed in this setting.

Ready

System Print Job **Print** Address Network

Settings

- Paper Handling
- Page Layout
- Printer Setting**
- Test Print
- Font Information

**PCL Settings**

Orientation  Portrait  Landscape

Size  (4.00-999.75)

Pitch  (0.44-99.99)

Font No.  (1-53)

Symbol Set

Form Length  (5-128)

Admin Password:

Item	Description
[Orientation]	Select the paper orientation.
[Size]	Displays the specified font size.
[Pitch]	Displays the specified font pitch.
[Font No.]	Displays the specified font number.
[Symbol Set]	Displays the selected symbol set.
[Form Length]	Displays the specified page length.

#### Tips

- The [Print] tab is displayed only when **Image Controller IC-209** is installed.

### 8.3.11 [Print] - [Test Print]

This item enables you to print the following test pages.

- Configuration Page
- PCL Font List

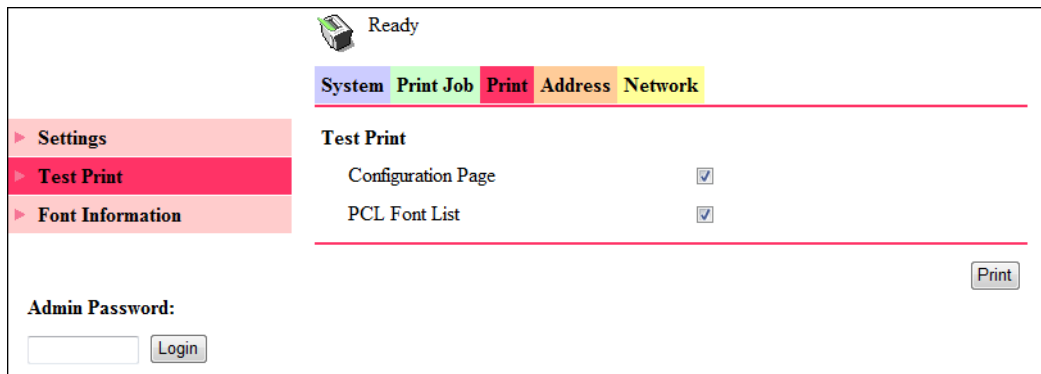

- 1 On the [Print] tab, click [Test Print].
  - 2 Select the test page you want to print.
  - 3 Click [Print].
- The selected test page is printed out.

Tips

- The [Print] tab is displayed only when **Image Controller IC-209** is installed.

### 8.3.12 [Print] - [Font Information]

This item enables you to check the PCL font list.

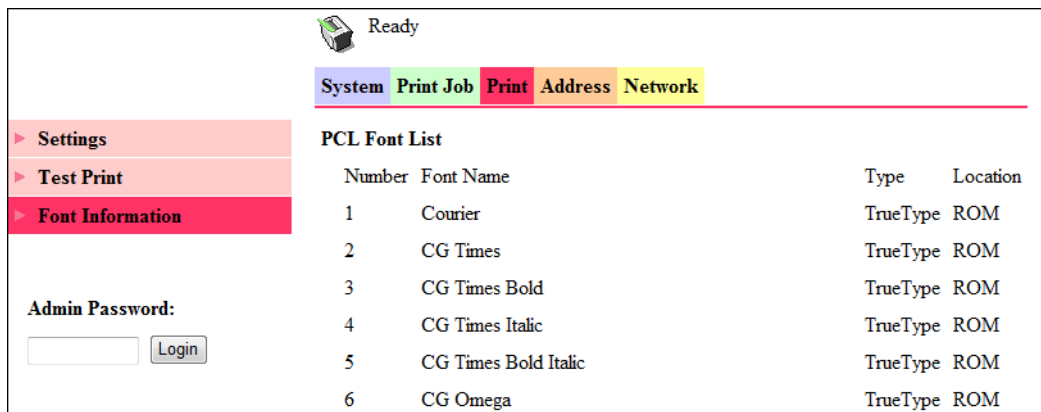

Tips

- The [Print] tab is displayed only when **Image Controller IC-209** is installed.

### 8.3.13 [Address] - [One-Touch Dial Setting]

This item enables you to check the registered one-touch dial settings.

 Ready

System
Print Job
Print
Address
Network

---

- ▶ One-Touch Dial Setting
- ▶ Speed Dial Setting
- ▶ Group Dial Setting

**Admin Password:**

**One-Touch Dial List**

No.	Name	Address	Batch
01	Sales A	0123456789	-
02	Sales B	sales_b@abc.com	-
03	ALL Sales	(Group Dial)	-
04	-	-	-
05	-	-	-
06	-	-	-

### 8.3.14 [Address] - [Speed Dial Setting]

This item enables you to check the registered speed dial settings.

 Ready

System
Print Job
Print
Address
Network

---

- ▶ One-Touch Dial Setting
- ▶ Speed Dial Setting
- ▶ Group Dial Setting

**Admin Password:**

**Speed Dial Index**

001-020	021-040	041-060	061-080	081-100
101-120	121-140	141-160	161-180	181-200
201-220	221-240	241-250		

**Speed Dial Index (Scan to Server)**

251-270	271-290	291-300
---------	---------	---------

**Speed 001-020** Top

No.	Name	Address
001	Email 192.168.0.20	user01@test.local
002	Sales B	1234567890
003	-	-
004	-	-
005	-	-
006	-	-

### 8.3.15 [Address] - [Group Dial Setting]

This item enables you to check the registered group dial settings.

 Ready

System
Print Job
Print
Address
Network

---

- ▶ One-Touch Dial Setting
- ▶ Speed Dial Setting
- ▶ **Group Dial Setting**

**Admin Password:**

**Group Dial List**

No.	Name	Address
01	Sales A	(Fax)
02	Sales B	(E-Mail)
03	ALL Sales	(Group Dial)
04	-	-
05	-	-
06	-	-

### 8.3.16 [Network] - [Summary]

This item enables you to check the basic network settings.

 Ready

System
Print Job
Print
Address
Network

---

- ▶ **Summary**

**Admin Password:**

**Summary**

Device Name	Ethernet 10/100BaseT
ROM Version	A3PE0778-3000-E00-26
IP Address	192.168.1.200
Hardware Address	08:20:8c:33:88:6c



**If This Message Appears**

---



## 9 If This Message Appears

### 9.1 Primary messages and corrective actions



#### Reference

For details on errors and corrective actions when using this machine or the copy function, refer to [User's Guide Copy].

Message	Cause	Correction action
[Paper jam] [Open 1st side cover]	A paper jam occurs in this machine.	Open the cover at the displayed position, and remove the jammed paper.
	Jammed paper is left in this machine.	Open the cover at the displayed position, and remove the jammed paper again.
[Original doc. jam] [Open doc. feed cover]	A paper jam occurs in the <b>ADF</b> . Jammed paper is left in the <b>ADF</b> .	Open the cover at the displayed position, and remove the jammed paper.
[Paper jam] [Open duplex cover]	A paper jam has occurred in <b>Automatic Duplex Unit AD-509</b> .	Open the cover of <b>Automatic Duplex Unit AD-509</b> , and remove the jammed paper.
[FRONT COVER OPEN] [CLOSE FRONT COVER]	The <b>Front Cover</b> of this machine is opened, or not set securely.	Securely close the <b>Front Cover</b> of this machine.
[DOCUMENT COVER OPEN CLOSE DOCUMENT COVER]	An original is loaded into the <b>ADF</b> while the <b>ADF</b> is opened.	Securely close the <b>ADF</b> .
[DOC.FEED COVER OPEN] [CLOSE DOC.FEED COVER]	The <b>Left Cover</b> of the <b>ADF</b> is opened.	Securely close the <b>Left Cover</b> .
[Toner empty]	Toner is depleted. Cannot copy or print data.	Install a new <b>Toner Bottle</b> .
[PAPER EMPTY] [LOAD PAPER (#XXX)]	Paper-out occurs in the selected tray. "#" indicates a tray, and "XXX" indicates the paper size.	Load paper of the displayed size into the displayed tray.
[PAPER SIZE ERROR] [RESET PAPER (#XXX)]	The paper loaded into the tray does not match the specified size. "#" indicates a tray, and "XXX" indicates the paper size.	Load the appropriate paper into the tray.
[COMMUNICATION ERROR (####)]	<ul style="list-style-type: none"> <li>A communication has failed due to an error occurred in this machine.</li> <li>A communication has failed for certain reasons related to the fax machine at the destination.</li> </ul>	Press any key to print out a sending or receiving result report and check the details of this error. Then, select the Utility screen to re-configure fax communication settings.
[REDIAL ALL FAILED]	All attempts to redial failed because the destination line was busy or no response was returned.	Press any key to check the line status of the destination, and retry the transmission job.
[MEMORY FULL]	Image data has caused a memory overflow during fax transmission.	<ul style="list-style-type: none"> <li>Remove the received data that is saved in the memory.</li> <li>Transmit a fax using the immediate transmission function.</li> </ul>
[MEMORY FULL]	Image data has caused a memory overflow during E-mail transmission.	Remove the received data that is saved in the memory.

Message	Cause	Correction action
[MEMORY FILE FULL]	The maximum number of memory files has been used during fax transmission.	Remove the received data that is saved in the memory.
[MEMORY FILE FULL]	The maximum number of memory files has been used during fax receiving.	Remove the received data that is saved in the memory.
[CANNOT CONNECT]	An error has occurred during connection with the server.	Reconfigure network settings in the Utility screen. If this error recurs after a communication has restarted, contact your network administrator.
[CANNOT GET IP]	Cannot obtain the IP address.	Respecify the IP address in the Utility screen. If this error recurs after a communication has restarted, contact your network administrator.
[WRONG PASSWORD]	Cannot connect to the POP3 server due to entry of an incorrect password.	Specify the correct POP3 password in the Utility screen. If this error recurs after a communication has restarted, contact your network administrator.
[RECEIVE WRONG DATA]	Data that cannot be printed on this machine was received. (The attached file is not of the TIFF-F type.)	Ask the sender to send a TIFF-F file or correct type of text file.
[SERVER MEMORY FULL]	A memory overflow has occurred in the transmission server during Internet fax transmission.	Delete the transmission data that is saved in the memory.
Error code: 0027	This machine is currently accessing the administrator mode of <b>PageScope Web Connection</b> , LSU, or RSD.	<ul style="list-style-type: none"> <li>• Log out from <b>PageScope Web Connection</b>.</li> <li>• Disconnect the LSU.</li> <li>• If no operation is performed for 600 seconds, the display returns to the basic screen.</li> <li>• For an RSD communication, consult your service representative.</li> </ul>



---

**10**

**If you suspect a failure then  
do the following**

---



## 10 If you suspect a failure then do the following

### 10.1 Having problems sending a fax

Fax status	Major cause	Corrective actions
The original is not scanned.	Is the original too thick?	Load the original on the <b>Original Glass</b> . For details, refer to [User's Guide Copy].
	Is the original too thin or small?	Load the original on the <b>Original Glass</b> . For details, refer to [User's Guide Copy].
	Is the <b>Original Glass</b> dirty?	Wipe the <b>Original Glass</b> with a soft, dry cloth.
The original is scanned obliquely.	Does the <b>Lateral Guide</b> match the original width?	Adjust the <b>Lateral Guide</b> to the original width. For details, refer to [User's Guide Copy].
An unclear image has been received in a destination.	Is the original positioned correctly?	Position the original correctly. For details, refer to [User's Guide Copy].
	Is the <b>Original Glass</b> dirty?	Wipe the <b>Original Glass</b> with a soft, dry cloth.
	Is the original text too faint?	Specify the scanning density. (p. 7-21)
	Is there a problem on the line status or destination fax?	Make a copy on this machine to check the result. If a copy image is clear, send the fax again.
A blank image has been received by the destination fax machine.	Has the original been loaded with the side containing the message facing down? (in use of <b>ADF</b> )	Load the original, ensuring that the side containing the message is facing up. Then, send the original again. For details, refer to [User's Guide Copy].
Cannot send a fax automatically.	Is the number correct?	Check the number.
	Are you calling a telephone-dedicated number?	Check the number.
	Is there a problem at the destination? (Paper out, Auto RX is disabled, the power is not turned off, and other causes)	Check with the sender.

## 10.2 Having problems receiving a fax

Fax status	Major cause	Corrective actions
The received image is not clear.	Is the specified paper being used?	Use the specified paper.
	Is the paper damp?	Replace with new paper.
	Is toner sufficient?	Install a new <b>Toner Bottle</b> . For details, refer to [Quick Guide].
	Is there a problem with a destination fax machine?	Make a copy on this machine to check the result. If a copy image is clear, ask the sender to send the fax again.
Blank paper is received.	Is toner sufficient?	Install a new <b>Toner Bottle</b> . For details, refer to [Quick Guide].
	Does the sender load the original, turning it over?	Check with the sender.
Faxes are not received automatically.	Has the Receive Mode been set to Manual RX?	Set to Auto RX. (p. 7-26)
	Is the memory full?	If paper out occurs, add paper, and print out files saved in the memory.
	Is a message displayed?	Release the message as instructed in the screen.
The received paper contains some black streaks.	Is there a problem with a destination fax machine?	Make a copy on this machine to check the result. If a copy image is clear, ask the sender to send the fax again.

## 10.3 Having problems making a call

Fax status	Major cause	Corrective actions
No sound is heard through an external phone.	Is the telephone cord connected to this machine?	Connect the telephone cord to this machine.
	Is the line cable connected to this machine?	Connect the line cable to this machine.
	During communication	After a communication has ended, check the connection again.
Cannot hear a tone after dialing.	Has the line type been specified correctly?	Specify the correct line type. (p. 2-16)
Difficult to hear the recipient's voice in the on-hook dial mode.	Is the monitor volume low?	Increase the monitor volume level. (p. 2-16)
The phone ring volume is low or high.	Is the ring volume of the external phone set to a low or high level?	Adjust the ring volume of the external phone.



---









**11** Others





# 11 Others

## 11.1 Fax specifications

Specifications	
Transmission mode	G3
Applied line	General telephone subscriber line
Connection type	Direct connection (Plug-in phone jack used)
Baud rate	33.6 / 31.2 / 28.8 / 26.4 / 24.0 / 21.6 / 19.2 / 16.8 / 14.4 / 12.0 / 9.6 / 7.2 / 4.8 / 2.4 kbps (Switched automatically)
Transmission time	3 sec.*
Scanning line density	8 dot/mm × 3.85/7.7/15.4 line/mm, 16 dot/mm × 15.4 line/mm**
Original size	Max. A3  Long original (Max. 39-1/2 inches (1,000mm)) available
Print paper size	11 × 17  to 5-1/2 × 8-1/2  , A3  , B4  , A4  /  , B5  , A5 
Number of sheets that can be scanned from memory	Standard (16MB): 1,024 sheets * For A4 standard original
Band compression system	MH / MR / MMR / JBIG

\* Indicates the speed when an A4-size original of approximately 700 characters is sent with the standard image quality (8 dots/mm × 3.85 lines/mm) in the high-speed mode (33.6 kbps). This is a transmission time only for image information, excluding the communication control time. The actual communication time varies depending on the contents of an original, destination model, and line conditions.

\*\* Supported only for immediate transmission using the **ADF**.

## 11.2 LSU

### 11.2.1 What is LSU?

LSU stands for Local Setup for Utility. If a computer with this application installed is connected to this machine, you can change the settings of this machine or view the counter or machine conditions.

LSU supports the following functions.

- Saving the information registered in the one-touch dial, speed dial, or group dial of this machine, in a computer
- Changing the information registered in the one-touch dial, speed dial, or group dial of this machine
- Configuring Utility settings of this machine
- Viewing the total counter
- Viewing the configuration page

### 11.2.2 LSU operating environment

To install LSU in a computer, the following conditions are required.

Operating environment	
Operating systems	Windows Vista (x86/x64) Windows Server 2008 (x86/x64) Windows Server 2008 R2 (x64) Windows 7 (x86/x64) Windows 8 (x86/x64) Windows 8.1 (x86/x64) Windows Server 2012 (x64) Windows Server 2012 R2 (x64)
CPU	Any processor of the same or higher specifications as recommended for your operating system.
Memory	Memory capacity as recommended for your operating system. Sufficient memory resource is required for your operating system and the applications to be used.

Connection interface

- USB 2.0 interface, USB cable

Tips

- Use a type A (4 pin, male) or type B (4 pin, male) USB cable. A USB cable measuring three meters or less is recommended.

### 11.2.3 Setup procedure

Before using LSU, connect this machine to a computer, and install LSU in a computer.

- 1 Connect this machine to the computer.
- 2 Install the TWAIN driver and printer driver supplied with this machine.
- 3 Install LSU in the computer.



#### Reference

*For details on how to install the TWAIN driver and printer driver, refer to [User's Guide Printer Operations] and [User's Guide Scan].*

*For details on how to install LSU, refer to page 11-5.*

### 11.2.4 Installing LSU

- 1 Insert the LSU DVD-ROM into the DVD-ROM drive of the computer.
- 2 Open the [LSU] folder on the DVD-ROM, and double-click [LSUSetup.exe].
- 3 Select your model.
- 4 Select a language.
- 5 Click [Next], and perform the procedure as instructed in the dialog box.
- 6 When the message appears to indicate that LSU installation has been finished, click [Finish].  
This completes the LSU installation process.

### 11.2.5 Starting LSU

- From the Start menu, click [All Programs] (or [Programs]) - [KONICA MINOLTA XXX] - [KONICA MINOLTA XXX].
- In Windows 8.1/Server 2012 R2, click [⬇] in the Start window. In the list, click [KONICA MINOLTA XXX].
- In Windows 8/Server 2012, click [KONICA MINOLTA XXX] in the Start window.  
The LSU screen appears.

## 11.2.6 LSU screen

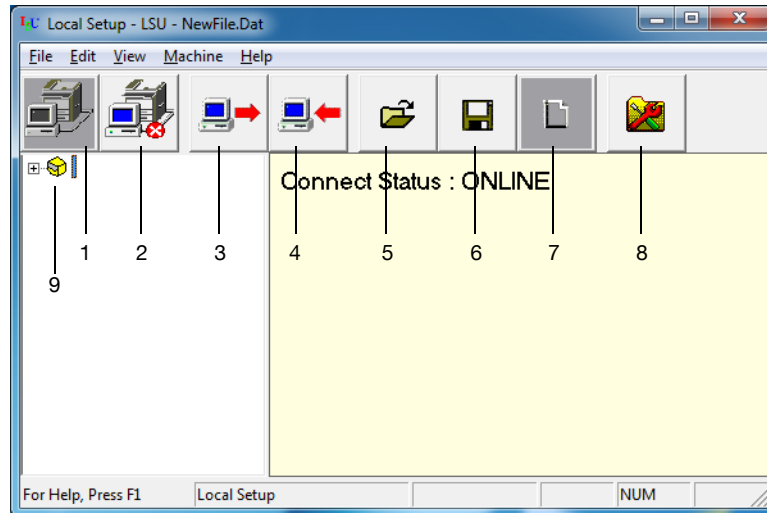

No.	Name	Description
1	Connection icon	Select this icon to connect LSU to this machine.
2	Disconnection icon	Select this icon to disconnect LSU from this machine.
3	Upload icon	Select this icon to send the configuration file to this machine.
4	Download icon	Select this icon to send the settings of this machine to a computer.
5	Open icon	Select this icon to open the configuration file.
6	Overwrite icon	Select this icon to overwrite the configuration file.
7	New creation icon	Select this icon to create a new file.
8	Utility setting icon	Select this icon to display the Utility setting screen.
9	This-machine icon	Select this icon  to display the one-touch dial, speed dial, and group dial of this machine.

## 11.2.7 Connecting LSU to this machine

→ Click .

When LSU is connected to this machine, [Connect Status:ONLINE] appears.

Tips

- You can also click [Machine] - [Connect] to connect LSU to this machine.
- You cannot use the **Control Panel** of this machine while operating LSU.

## 11.2.8 Downloading the registered information from this machine

→ Click .

Tips

- You can also click [Machine] - [Download] to download information.

### 11.2.9 Creating a new configuration file

→ Click .

Tips

- You can also click [File] - [New] to create a configuration file.
- If LSU is already connected to this machine, you cannot create a new file. Click the disconnection icon to disconnect LSU from this machine.

### 11.2.10 Registering destinations in the one-touch dial

- 1 Click the this-machine icon , and also click [One-Touch].
- 2 Double-click a target number in the displayed list.  
→ Up to 32 destinations can be registered in the one-touch dial.
- 3 Enter the required items.

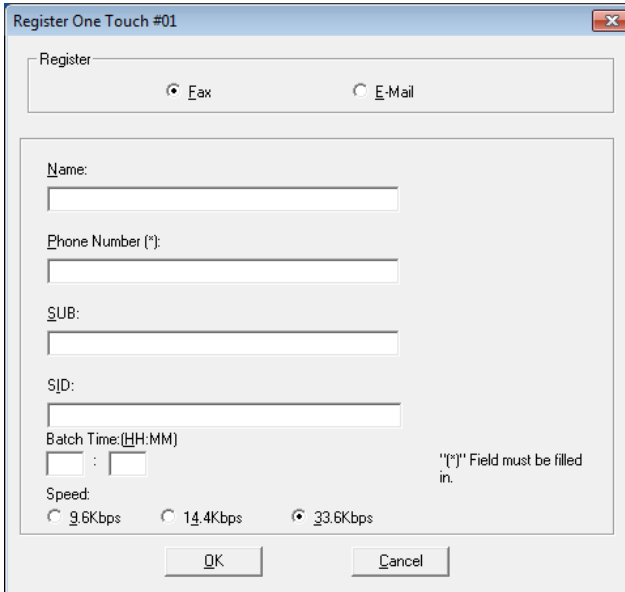

→ The character string entered in the [Name] field is displayed as a destination name on the **Display**.

- 4 Click [OK].  
This completes the one-touch dial registration process.

### 11.2.11 Editing a one-touch dial destination

→ Click the this-machine icon , and also click [One-Touch].

When necessary, select a desired destination from the one-touch dial list to change its setting.

Tips

- When editing the registered information, select [Cut], [Copy], [Paste], or [Delete] on the [Edit] menu.

### 11.2.12 Registering destinations in the speed dial

- 1 Click the this-machine icon , and also click [Speed Dial].
- 2 Double-click a target number in the displayed list.  
→ Up to 250 destinations can be registered in the speed dial.
- 3 Enter the required items.

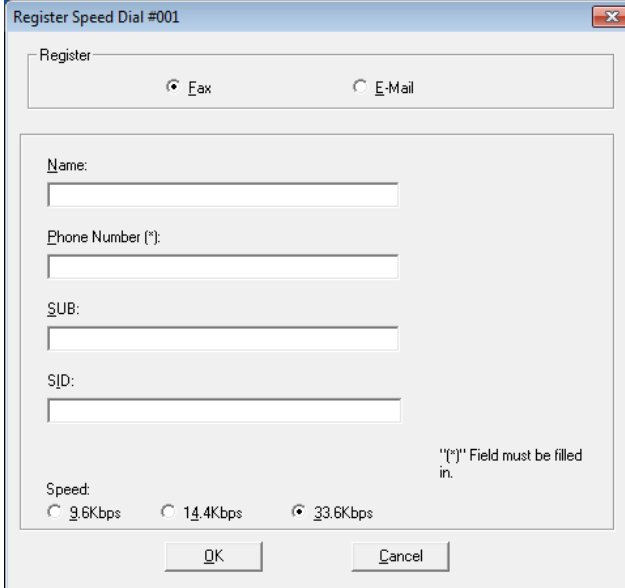

The dialog box titled "Register Speed Dial #001" contains the following elements:

- A "Register" section with two radio buttons: "Fax" (selected) and "E-Mail".
- Four text input fields labeled "Name:", "Phone Number (\*)", "SUB:", and "SID:". The "Phone Number (\*)" field has an asterisk indicating it is required.
- A "Speed:" section with three radio buttons: "9.6Kbps", "14.4Kbps", and "33.6Kbps" (selected).
- Buttons for "OK" and "Cancel" at the bottom.
- A note at the bottom right: "('\*') Field must be filled in."

→ The character string entered in the [Name] field is displayed as a destination name on the **Display**.

- 4 Click [OK].  
This completes the speed dial registration process.



### 11.2.13 Editing a speed dial destination

- Click the this-machine icon , and also click [Speed Dial].
- When necessary, select a desired destination from the speed dial list to change its setting.

#### Tips

- When editing the registered information, select [Cut], [Copy], [Paste], or [Delete] on the [Edit] menu.

### 11.2.14 Registering destinations in the group dial

- ✓ Register the group dial after registering the one-touch dial and speed dial.
  - ✓ Up to 50 destinations can be registered in the group dial.
- 1 Click the this-machine icon , and also click [Group].
  - 2 Double-click a target number in the displayed list.
  - 3 Select a target number to be registered with the group, and click  .

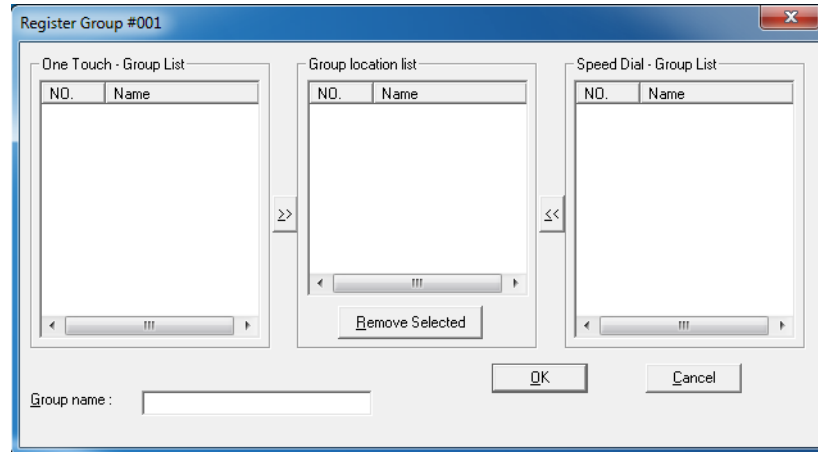

- 4 Enter a group name.
  - The character string entered in the [Name] field is displayed as a destination name on the **Display**.
- 5 Click [OK].
  - This completes the group registration process.

### 11.2.15 Editing a destination in the group dial

- Display the group dial list, and select a group number to be edited.
  - When necessary, select a desired destination from the group dial list to change its setting.

### 11.2.16 Printing out the one-touch dial, speed dial, or group dial list

- 1 Click [File] - [Print].
  - The following screen appears.

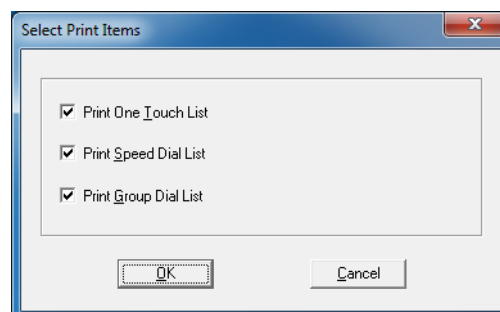

- 2 Select a target check box, and click [OK].

### 11.2.17 Saving settings in a computer

- 1 Click .
  - You can also click [File] - [Save As...] to save settings.
- 2 Specify a folder to save the file in, and enter a file name.
- 3 Click [Save].

### 11.2.18 Saving settings on this machine

- Click , and send settings to this machine.

Tips

- You can also click [Machine] - [Upload] to save data on this machine.

### 11.2.19 Saving the Utility settings

The Utility settings can be configured using the utility setting screen of LSU instead of using the **Control Panel** of this machine.

Tips

- You cannot use the **Control Panel** of this machine while operating LSU.

- Click .

The Utility Setting screen appears.

- You can also click [Machine] - [Utility Setting] to display the Utility Setting screen.

The following items can be configuring using LSU.

Tabs	Item	
Machine Setting	Auto Panel Reset	
	Auto Shut Time	
	Density (ADF)	
	Buzzer Volume	
	Initial Mode	
	Density (BOOK)	
	Language	
	Scan threshold	
	Sleep Mode	
	LCD contrast	
	Print Density	
	Key Speed Setting	
	Paper Source	Tray1 Paper
Auto, Inch/Metric, Paper Size		
Tray 2 to 5 Setting		Inch/Metric
		Media Type



<b>Tabs</b>	<b>Item</b>
Copy Setting (1)	Paper Priority
	Quality Priority
	Density Priority
	Density Level (A)
	Density Level (M)
	Duplex Priority
	Output Bind Pos.
	Orig. Binding Pos.
	Page Margin Setting
	Small Original
	Binding Position
	Erase Setting
Copy Setting (2)	Copy Priority
	Output Priority
	4-IN1 Copy Order
	Mixed Original
	Crisscross Mode
	Orig. Direction
	Book separation
	Stamp
	Page Format
	DateTime Format
FAX TX Operation	Density Level
	Quality Priority
	Default Tx
	Header
	Confirm Fax No.
FAX RX Operation	Memory RX Mode
	Reduction RX
	RX Print
	RX Mode
	No. of rings
	Select Tray
	Forward Mode
	Footer
	Closed Network
Report Setting	Activity Report
	Reservation Report
	TX Result Report
	RX Result Report
Scan Setting	Quality Priority
	Image Format
	BW Coding Method
	Color Setting

## 11.2.20 Configuring administrator settings

- 1 Click [Machine] - [Admin. Management].
  - 2 Enter the administrator number.  
The Administrator Settings screen appears.
- The following items can be configuring using LSU.

<b>Tabs</b>	<b>Item</b>
Administrator Mode	Display Auto Shut
	Sleep Shift
	Account Track
	Remote Monitor
	Change Admin No.
	Scan to USB
Network Setting	Auto / Specify IP address
	IP Address
	Subnet Mask
	Gateway
	DNS Configuration
	IPv6
	Web Setting
	LPD Setting
	SLP Setting
	SNMP Setting
	Auto Get Time
E-Mail Setting (1)	Sender Name
	E-Mail Address
	SMTP Server Address
	SMTP Port No.
	SMTP Timeout
	Default Subject
	E-Mail Mode
	TEXT Insert
POP Before SMTP	
E-Mail Setting (2)	POP3 Server Address
	POP3 Account
	POP3 Password
	POP3 Port No.
	POP3 Timeout
	Auto reception
	Reply address
Header Print	

Tabs	Item
LDAP Setting	LDAP Server
	LDAP Port No.
	Search Base
	Search Method
	LDAP Timeout
	Max. Search Results
	LDAP Account
	LDAP Password
	Domain Name
	ATTRIBUTE
	SSL Setting
	Authentication Mode
Communication Setting	Tone/Pulse
	Line Monitor
	PSTN/PBX
Machine Information	Time Zone
	Datelight Saving
	Name
	Fax No.

### 11.2.21 Viewing the total counter

- Click [Machine] - [Total Counter].  
The total counter appears.

### 11.2.22 Viewing the configuration page

- Click [Machine] - [Configuration].  
The machine setting list appears.

### 11.2.23 Uninstalling LSU

- 1 Start the deletion program.
  - From the Start menu, click [All Programs] (or [Programs]) - [KONICA MINOLTA XXX] - [Uninstall].
  - In Windows 8.1/Server 2012 R2, click [⊕] in the Start window, select [Control Panel] - [Programs], then click [Uninstall a program]. In the list, double-click [KONICA MINOLTA XXX].
  - In Windows 8/Server 2012, right-click the Start window, select [All apps] - [Control Panel] - [Programs], then click [Uninstall a program]. In the list, double-click [KONICA MINOLTA XXX].
- 2 Follow the subsequent on-screen instructions.

## 11.3 Glossary

Explanation of terms

Term	Description
Auto redial	This function automatically recalls a destination if a communication fails because the destination is busy. When the memory contains multiple originals queued for sending, they are moved forward and sent in sequence until the recalling time is reached.
Book original	Bound original such as a book or booklet
F-Code	The F code is a mail box function that uses [SUB (SUB address)], [SEP (selective polling)], and [SID], [PWD] (password) that are defined in the G3 standard of the International Telecommunication Union (ITU-T). A confidential communication or relay instruction transmission is available between machines compatible with an F code.
G3 communication	Establishes a communication in the G3 standard (international facsimile standard). A fax communication is established using an analog line (general telephone subscriber line).
Internet fax	Establishes a fax communication via Internet or intranet instead of a telephone line. You can specify an E-mail address instead of a fax number to send a scanned image (in TIFF format) to a computer or Internet fax as an E-mail file. You can also receive an E-mail sent from a computer as an image.
General subscriber line	Analog telephone line on the public network.
JBIG encoding method	A new data compression-extension method, which is determined in the Joint Bi-level Image Expert Working Group that is a part of the ITU-T (International Telecommunication Union). This method is effective when transferring a large amount of halftone data or high-resolution data.
Manual RX	This function allows you to receive an original after speaking with the sender by phone.
Manual transmission	This function allows you to send an original after speaking with the recipient by phone.
Memory	Used to save image data to be faxed or copied. Extending the memory allows you to store more image data in the memory.
Network scanner	This function sends a scanned image to a computer via the network. The scanned data can be sent as an E-mail file or uploaded to the FTP or SMB server.
On-hook	This function allows you to dial while the phone remains put on the hook. To use this function, press the <b>On Hook</b> key.
PBX (Private Branch exchange)	An abbreviation of Private Branch exchange. PBX allows you to connect multiple telephone sets to a couple of local station lines or freely connect those telephones as extensions.
Push signal	Electric signals used in a telephone communication that sound "beep boop beep" when you use a push telephone line (PB). This is used when using a push telephone line for calling or using the push-button phone service. Pressing $\times$ on the <b>Keypad</b> allows you to use the push signal service via a dialing telephone line.

---

# 12

Index



## 12 Index

### 12.1 Index by item

#### Numerics

1-sided original *2-9*

2-sided original *2-9*

#### A

Activity report *3-22*

Address Book *3-13*

Address Book Search *5-5*

Address Search *5-5*

Administrator settings *11-12*

Auto RX *3-27*

#### B

Basic or Advanced *5-8*

Batch transmission *3-26*

#### C

Canceling a transmission *3-20*

Canceling a transmission reservation *3-20*

Canceling the Relay User Box setting *7-20*

Chain dial *3-14*

Changing or deleting a Group dial destination *7-12*

Changing or deleting a one-touch dial destination *7-8*

Changing or deleting a speed dial destination *7-10*

Changing or deleting the confidential transmission program *7-15*

Changing or deleting the polling RX program *7-15*

Changing or deleting the relay instruction transmission program *7-16*

Changing or deleting the sequential broadcast transmission program *7-14*

Changing or deleting the specified-time transmission program *7-14*

Check speed dial settings *8-13*

Checking group dial settings *8-14*

Checking network settings *8-14*

Checking one-touch dial settings *8-13*

Checking the communication result *3-21*

Confidential communication *4-5*

Confidential reception *4-7*

Confidential transmission *4-6*

Configuration page *3-23*

Configuring footer printing *7-26*

Configuring header printing *7-22*

Configuring sender information *6-11*

Configuring the closed network *7-27*

Configuring the fax number confirmation function *7-22*

Configuring the forward mode *7-26*

Configuring the print reduction *7-25*

Configuring the RX mode *7-26*

Configuring the RX printing *7-25*

Configuring transmission settings *5-7*

Copy mode *2-8*

Corrective actions *9-3*

Custom Size *3-5*

#### D

Default settings *2-11*

Deleting a destination or group *6-13*

Deleting a document sent by polling *4-9*

Deleting the Confidential User Box setting *7-18*

Download *8-9*

#### E

Editing a destination in the address book *6-12*

Editing a destination in the group dial *11-9*

Editing a group *6-13*

Editing a one-touch dial destination *11-7*

Editing a speed dial destination *11-8*

Entering a fax number *3-8*

Entry mode *2-7*

Export *6-14*

#### F

Fax cover sheet *6-9*

Fax driver *6-4*

Fax driver settings *6-10*

Fax mode *2-8*

Fax Registration *7-17*

Fax RX settings *7-23*

Fax settings *7-3*

Fax specifications *11-3*

Fax TX settings *7-21*

F-Code TX *4-3, 4-5*

Forward *4-14*

#### G

Group dial *3-11*

#### I

Image quality *3-7*

Immediate transmission *3-24*

Import *6-14*

Initial mode *2-8*

Install *6-6*

Installation (LSU) *11-5*

Internet fax *5-3*

#### K

Key setting list *3-23*

**L**

LSU 11-4

**M**

Machine status list 3-23  
 Making a call 3-29  
 Manual redialing 3-16  
 Manual RX 3-28  
 Manual transmission 3-19  
 Memory 3-24  
 Memory image print 3-22  
 Memory RX 3-27  
 Memory shortage 3-17  
 Memory transmission 3-24  
 Message 2-7  
 Messages 9-3  
 Mixed original 2-9

**O**

One touch dial 3-9  
 One-touch dial list 3-23  
 Online Assistance 8-8  
 Original Glass 2-9, 3-6  
 Original size 2-9  
 Original types 2-9

**P**

PageScope Web Connection 8-3  
 Paper Size 8-10  
 Paper size of received document 3-27  
 PASSWORD(SID) 4-3, 4-5  
 PC-FAX 6-3  
 PCL font list 3-23, 8-12  
 PCL Setting 8-11  
 Pictogram 2-8  
 POLL ID(SEP) 4-3  
 Polling RX 4-10  
 Polling TX 4-8  
 Print Job 8-9  
 Printing out the one-touch dial, speed dial, or group dial list 11-9  
 Program dial 3-12  
 Push telephone line 2-16

**R**

Receiving a call 3-30  
 Receiving an Internet fax 5-13  
 Receiving an Internet fax automatically 5-14  
 Receiving an Internet fax manually 5-14  
 Receiving data 3-27  
 Registering a destination in the address book 6-12  
 Registering a group 6-13  
 Registering a local fax number 2-14  
 Registering the Confidential User Box 7-17  
 Registering the group dial 7-11, 11-9  
 Registering the one-touch dial 7-7, 11-7  
 Registering the program dial 7-13

Registering the Relay User Box 7-19  
 Registering the speed dial 7-9, 11-8  
 Relay Box list 3-23  
 Relay broadcasting 4-13  
 Relay instruction transmission 4-11  
 Releasing the memory RX mode 7-24  
 Remaining amount of memory 2-7  
 Report or List Types 3-22  
 Report Settings 7-28  
 Report/List 3-21  
 RX Result Report 3-22

**S**

Saving settings 11-10  
 Saving the Utility settings 11-10  
 Selecting a tray 7-27  
 Selecting whether to automatically print out a Activity Report 7-28  
 Selecting whether to automatically print out a receiving result report 7-29  
 Selecting whether to automatically print out a reservation report 7-28  
 Selecting whether to automatically print out a transmission result report 7-29  
 Sender name 2-15  
 Sending a fax 6-8  
 Sequential broadcast transmission 3-15  
 Specified-time transmission 3-25  
 Specifying a Destination 3-8  
 Specifying a forward destination 5-11  
 Specifying a title 5-11  
 Specifying header printing 5-12  
 Specifying the communication line 2-17  
 Specifying the compression coding method 5-9  
 Specifying the current date and time 2-12  
 Specifying the default TX mode 7-22  
 Specifying the density 5-10  
 Specifying the image quality 5-10  
 Specifying the line monitor sound 2-16  
 Specifying the line type 2-16  
 Specifying the maximum transmission resolution 5-8  
 Specifying the maximum transmission size 5-8  
 Specifying the memory RX mode 7-24  
 Specifying the number of rings 7-25  
 Specifying the quality priority 7-22  
 Specifying the scanning density 7-21  
 Specifying the transmission time 5-7  
 Speed dial 3-10  
 Speed dial list 3-23  
 Store Address 7-6  
 SUB 4-3, 4-6

**T**

Test Print 8-12  
 TIMER SETTING 5-7  
 TX Result Report 3-22



**U**

Uninstallation *6-6*

Uninstalling LSU *11-13*

User mode *8-6*

Using the ADF *2-9*

**V**

Viewing the configuration page *11-13*

Viewing the total counter *11-13*

## 12.2 Index by button

### A

A3 5-8  
 A4 5-8  
 ACTIVITY REPORT 7-28  
 Add Group 6-13  
 Address 6-11  
 Address Book 6-12  
 AddressBook 3-13  
 ADMIN. MANAGEMENT 7-4, 7-5  
 Admin. Management 11-12  
 ADVANCED 5-8  
 AUTO RECEPTION 5-14, 7-4

### B

B4 5-8  
 BASIC 5-8  
 BASIC/ADVANCED 5-8  
 BROADCAST 3-15  
 BUZZER VOLUME 7-4

### C

CANNOT CONNECT 9-4  
 CANNOT GET IP 9-4  
 CAUTION 7-4  
 CLOSE DOC.FEED COVER 9-3  
 CLOSE FRONT COVER 9-3  
 CLOSED NETWORK 7-23, 7-27  
 CODING METHOD 5-9  
 COMM. SETTING 7-5  
 COMMUNICATION ERROR (####) 9-3  
 Company Name 6-11  
 COMPLETE 7-4  
 Configuration 11-13  
 CONFIRM FAX NO. 7-21, 7-22  
 CONFIRMATION 7-4  
 Consumable 8-7  
 Copies 8-10  
 Cover Sheet 6-9  
 Cover Sheet Information 6-9

### D

Date/Time 6-9  
 DATE&TIME 2-12, 7-5  
 DEFAULT TX 7-21  
 DEFAULT SUBJECT 5-11  
 DEFAULT TX 7-22  
 Delete 6-13  
 Density 5-10  
 DENSITY LEVEL 7-21  
 Department 6-11  
 Destination List 6-8, 6-9  
 DIAL REGISTRATION 7-3  
 DISABLE/ENABLE 7-4

DOC.FEED COVER OPEN 9-3  
 DOCUMENT COVER OPEN CLOSE DOCUMENT  
 COVER 9-3

### E

Edit 6-13  
 E-mail Address 6-11  
 E-MAIL SETTINGS 2 7-4  
 Enter Power Save Mode 8-8  
 Export 6-14

### F

Fax Number 6-8, 6-11  
 FAX REGISTRATION 7-3  
 FAX RX OPERATION 7-3  
 FAX TX OPERATION 7-3  
 File Path 6-9  
 FINE 5-8  
 Font No. 8-11  
 FOOTER 7-23, 7-26  
 Form Length 8-11  
 FORWARD 7-23, 7-26  
 FRONT COVER OPEN 9-3

### G

GROUP DIAL 7-6  
 Group 11-9  
 GROUP DIAL 7-11

### H

HEADER 7-21, 7-22  
 HEADER PRINT 5-12, 7-4

### I

Import 6-14  
 INITIAL MODE 7-4  
 Input Tray 8-6  
 Insert Image 6-9  
 Interface Information 8-7  
 IPv4 Configuration 6-5

### L

LDAP SEARCH 5-5  
 LINE MONITOR VOLUME 7-5  
 LIST 3-13  
 LOAD PAPER (#XXX) 9-3  
 LPD Setting 6-5

### M

MACHINE SETTING 7-4  
 MAIL BOX 7-17  
 MAILBOX 7-17  
 MAILBOX TX 4-6  
 MAX QUALITY 5-8  
 MAX TX SIZE 5-8  
 Media Path 8-10  
 MEMORY FILE FULL 9-4

MEMORY FULL 9-3  
 MEMORY RX MODE 7-23, 7-24  
 MH 5-9  
 MMR 5-9  
 MR 5-9  
 MULTI 4-8, 4-9

**N**

Name 6-8, 6-11  
 NO. of RINGS 7-23, 7-25

**O**

One-Touch 11-7  
 ONE-TOUCH DIAL 7-6, 7-7  
 Open 1st side cover 9-3  
 Open doc. feed cover 9-3  
 Open duplex cover 9-3  
 Orientation 6-10, 8-11  
 Original doc. jam 9-3  
 Output Tray 8-7

**P**

Page Layout 6-10  
 PAPER EMPTY 9-3  
 Paper jam 9-3  
 Paper Size 6-10  
 PAPER SIZE ERROR 9-3  
 Paper Source 8-10  
 PBX 2-17  
 Pitch 8-11  
 POLLING RX 4-10  
 POLLING TX 4-8, 4-9  
 PREPARATION 7-4  
 Print 11-9  
 PRINT MAILBOX RX 4-7  
 PRINT REPORT 3-21  
 PROGRAM DIAL 7-6, 7-13  
 PSTN 2-17  
 PSTN/PBX 7-5  
 PULSE 2-16

**Q**

Quality 5-10  
 QUALITY PRIORITY 7-21, 7-22

**R**

RECEIVE E-MAIL 5-14  
 RECEIVE WRONG DATA 9-4  
 REDIAL ALL FAILED 9-3  
 Redial/Pause 3-16  
 REDUCTION RX 7-23, 7-25  
 RELAY BOX 7-17, 7-19  
 RELAY INITIATE 4-11  
 REMOTE MONITOR 7-4  
 REPLY ADDRESS 5-11, 7-4  
 REPORTING 7-3  
 RESERVATION REPORT 7-28  
 RESET PAPER (#XXX) 9-3

Resolution 6-10  
 ROM Version 8-7  
 RX MODE 7-23, 7-26  
 RX PRINT 7-23, 7-25  
 RX RESULT REPORT 7-28, 7-29

**S**

Save As... 11-10  
 SEARCH 3-13  
 Select Cover Sheet 6-9  
 SELECT TRAY 7-23, 7-27  
 Sender 6-9  
 Sender Information 6-11  
 SERVER MEMORY FULL 9-4  
 S-FINE 5-8  
 SINGLE 4-8, 4-9  
 Size 8-11  
 Sleep Time 8-8  
 SPEED DIAL 7-6, 7-9  
 Speed Dial 11-8  
 SUB, SID SETTING 4-3, 4-4  
 Subject 6-9  
 Symbol Set 8-11

**T**

Telephone No. 6-11  
 TIMER SETTING 5-7  
 TONE 2-16  
 TONE/PULSE 7-5  
 Toner empty 9-3  
 Total Counter 11-13  
 TX RESULT REPORT 7-28, 7-29  
 TX/RX RESULT 3-21

**U**

Upload 11-10  
 USER FAX NO. 2-14  
 USER NAME 2-15, 7-5  
 USER SETTING 7-5  
 Utility Setting 11-10

**V**

View 6-12

**W**

WRONG PASSWORD 9-4

**X**

X 6-9

**Y**

Y 6-9

**Z**

Zoom 6-9

