

WD ShareSpace™

Network Storage System
User Guide

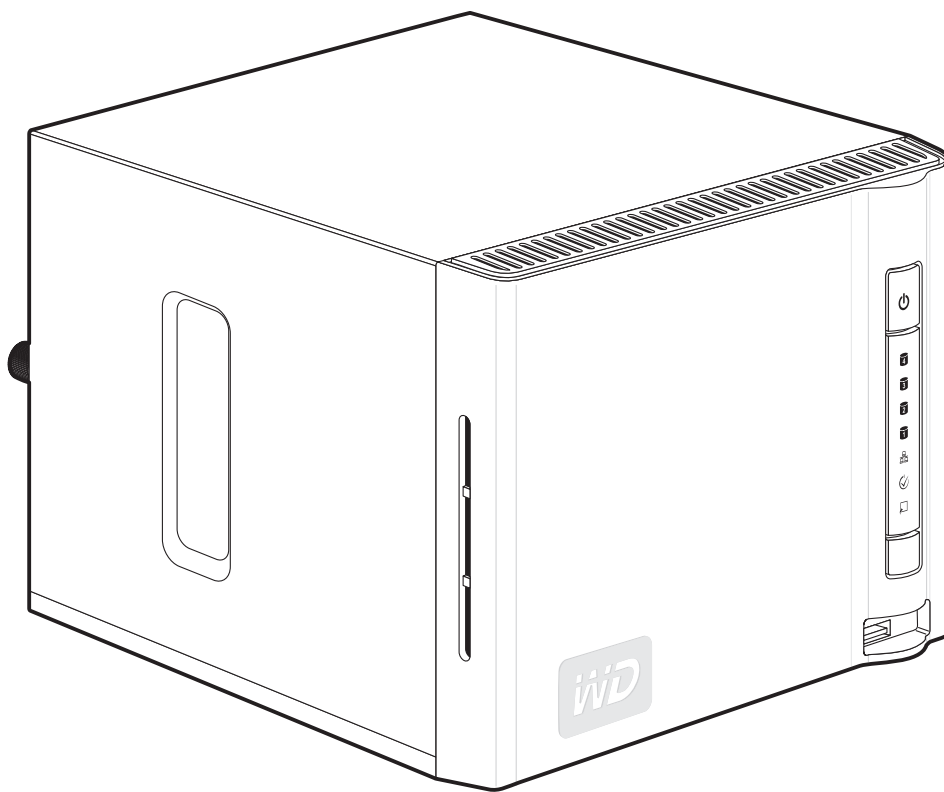

Important Safety Instructions

1. Follow all warnings and instructions marked on the product.
2. Unplug this product from the wall outlet before cleaning. Do not use liquid cleaners or aerosol cleaners. Use a damp cloth for cleaning.
3. Do not use this product near any liquids.
4. Do not place this product on an unstable surface. The product may fall, causing serious damage to the product.
5. Do not drop the product.
6. Do not block the slots and openings on the back or bottom side of the chassis; to ensure proper ventilation and reliable operation of the product and to protect it from overheating, these openings must not be blocked or covered.
7. Operate this product only from the type of power indicated on the marking label. If you are not sure of the type of power available, consult your dealer or local power company.
8. Do not allow anything to rest on the power cord. Do not locate this product where persons will walk on the cord.
9. If an extension cord is used with this product, make sure that the total ampere rating of the equipment plugged into the extension cord does not exceed the extension cord ampere rating. Also, make sure that the total rating of all products plugged into the wall outlet does not exceed the fuse rating.
10. Never push objects of any kind into this product through the chassis slots as they may touch dangerous voltage points or short out parts that could result in a fire or electric shock.
11. Unplug this product from the wall outlet and refer servicing to qualified service personnel under the following conditions:
 - a When the power cord or plug is damaged or frayed.
 - b If liquid has been spilled on the product.
 - c If the product has been exposed to rain or water.
 - d If the product does not operate normally when the operating instructions are followed. Adjust only those controls that are covered by the operating instructions since improper adjustment may result in damage and require extensive work by a qualified technician to the product to normal condition.
 - e If the product has been dropped or the chassis has been damaged.
 - f If the product exhibits a distinct change in performance, indicating a need for service.
12. In accordance with workstation regulation standards, do not place this device in the visual field of the user due to the glossy front of the case.



.....

WARNING! The WD ShareSpace uses a lithium battery, type CR2032. There is danger of an explosion if the battery is incorrectly replaced. Replace only with the same or equivalent battery type recommended by the manufacturer. Dispose of used batteries according to the manufacturer's instructions.

Table of Contents

WD Service and Support	1
Registering Your WD Product	2
<hr/>	
1 Overview	3
Format and Configuration	3
Specifications	3
Kit Contents	4
Accessories	4
System Requirements	5
Pre-installation	5
Recording Your WD Product Information	6
System View	6
LED Indicators	7
USB Backup Button	8
Ports	8
Reset Button	8
Kensington Security Slot	8
<hr/>	
2 WD ShareSpace Basic Setup	9
Step 1: Connect WD ShareSpace to the Network	9
Step 2: Access WD ShareSpace on the Network	10
WD ShareSpace File Storage	17
<hr/>	
3 Backing Up Computers on a Network	18
WD Anywhere Backup Overview	18
Installing WD Anywhere Backup	18
Configuring WD Anywhere Backup	24

4	MioNet Remote Access	41
	MioNet Overview	41
	Remote Access Setup	41
	Using MioNet Web (after registration)	44
5	How to Play/Stream Video, Music & Photos	51
	Media Server Overview	51
	Media Types Supported	51
	Media Storage	52
	Media Devices	53
6	Using iTunes with WD ShareSpace	58
	iTunes Media Server Overview	58
	Media Types Supported	58
	Storing Content	58
	Streaming Audio in iTunes	58
7	External USB Drive Sharing & Backup	60
	Sharing Data on a USB Drive	60
	USB Auto Backup Feature	60
8	Using WD Discovery (Windows Only)	63
	WD Discovery Overview	63
	Mapping a Network Drive	63
	Browse Network Shares	66
	Desktop Shortcut Creation	67
	Turning Identify LED On or Off	67
9	Network Storage Manager: Basics	69
	Configuring WD ShareSpace	69
	WD ShareSpace's Network Storage Manager Features	76
	User Interface Overview	77
	Basic Mode	78

10	Network Storage Manager: Advanced	87
	System Tab	88
	Network Tab	101
	Storage Tab	109
	Media Tab	125
	Users Tab	128
	Status Tab	136
<hr/>		
11	Scheduled Downloads	141
	Downloader Features	142
<hr/>		
12	Replacing a Drive	147
	ESD precautions	147
<hr/>		
13	Troubleshooting	151
<hr/>		
14	Glossary	159
<hr/>		
15	Appendix	164
	Regulatory Compliance	164
	Environmental Compliance (China)	165
	Warranty Information	165
	GNU General Public License (“GPL”)	166
<hr/>		
	Index	168

WD Service and Support

Should you encounter any problem, please give us an opportunity to address it before returning this product. Most technical support questions can be answered through our knowledge base or e-mail support service at support.wdc.com. If the answer is not available or, if you prefer, please contact WD at the best telephone number shown below.

Your product includes 30 days of free telephone support during the warranty period. This 30-day period starts on the date of your first telephone contact with WD technical support. E-mail support is free for the entire warranty period and our extensive knowledge base is available 24/7. To help us keep you informed of new features and services, remember to register your product online at <https://www.wdc.com/register>.

Accessing Online Support

Visit our product support website at support.wdc.com and choose from these topics:

- **Downloads** - Download drivers, software, and updates for your WD product.
- **Registration** - Register your WD product to get the latest updates and special offers.
- **Warranty & RMA Services** - Get Warranty, Product Replacement (RMA), RMA Status, and Data Recovery Information.
- **Knowledge Base** - Search by keyword, phrase, or answer ID.
- **Installation** - Get online installation help for your WD product or software.

Contacting WD Technical Support

When contacting WD for support, have your WD product serial number, system hardware, and system software versions available.

North America		Asia Pacific	
English	800.ASK.4WDC (800.275.4932)	Australia	1 800 42 9861
Spanish	800.832.4778	China	800 820 6682/+65 62430496
		Hong Kong	+800 6008 6008
		India	1 800 11 9393 (MNTL)/1 800 200 5789 (Reliance) 011 26384700 (Pilot Line)
		Indonesia	+803 852 9439
Europe (toll free)*	00800 ASK4 WDEU (00800 27549338)	Japan	00 531 650442
		Korea	+82-2-2093-1007
Europe	+31 880062100	Malaysia	+800 6008 6008/1 800 88 1908/+65 62430496
Middle East	+31 880062100	Philippines	1 800 1441 0159
Africa	+31 880062100	Singapore	+800 6008 6008/+800 608 6008/+65 62430496
		Taiwan	+800 6008 6008/+65 62430496

* Toll free number available in the following countries: Austria, Belgium, Denmark, France, Germany, Ireland, Italy, Netherlands, Norway, Spain, Sweden, Switzerland, United Kingdom.

Registering Your WD Product

Your WD product includes 30 days of free technical support during the applicable warranty period for your product. The 30-day period commences on the date of your first telephone contact with WD technical support. Register online at register.wdc.com.

1

Overview

Congratulations on your purchase of WD ShareSpace™, a high-speed network attached storage system with a space-saving footprint. This system is equipped with WD drives using WD GreenPower™ technology for efficient cooling and power saving. The multi-level RAID support and high-speed interfaces deliver high performance for small offices or home users and is ideal for backing up and sharing files over the Internet.

This user manual provides step-by-step installation instructions and other important information regarding your WD product. For the latest WD product information and news, visit our website at www.westerndigital.com.

Format and Configuration

WD ShareSpace is preformatted for maximum reliability as a RAID 5 volume (for four-drive systems) or for maximum capacity as a single large, spanned volume (for two-drive systems). In RAID 5, one quarter of the capacity is used to store parity information needed to restore data in the event of a drive failure. In a spanned volume, the capacity is equal to the total of all drives in the volume. To access the maximum capacity using four drives on this device, the RAID configuration must be reset to either RAID 0 or Span. For more information on how to set up RAID, see “Manage RAID” on page 114.

Specifications

Ethernet	High performance (10/100/1000) Gigabit Ethernet connection
Internal hard drives	Up to four WD 3.5-inch SATA hard drives
External USB storage file systems supported	NTFS, FAT/FAT32
Supported protocols	HTTP, HTTPS, CIFS/SMB, NFS, FTP
I/O ports	<ul style="list-style-type: none"> ▪ Three USB 2.0 ports (one front for file backup, two rear for USB device expansion) ▪ Ethernet (RJ-45) port
Supported clients	<ul style="list-style-type: none"> ▪ Windows® 2000/XP/Vista (latest service packs required)/Server 2003 ▪ Mac OS® X Tiger® or Leopard®
Physical dimensions	<ul style="list-style-type: none"> ▪ Width: 6.30 in (160.1 mm) ▪ Height: 7.73 in (196.2 mm) ▪ Length: 7.84 in (199.18mm) ▪ Weight: 5.28 lb (2.4 kg)
Power consumption	<ul style="list-style-type: none"> ▪ Input voltage: 100V to 240V AC ▪ Input frequency: 50 to 60 Hz
Environmental	<ul style="list-style-type: none"> ▪ Operating temperature: 5 to 35 °C (41 to 95 °F) ▪ Non-operating temperature: -20 to 65°C (-4 to 149 °F)

Kit Contents

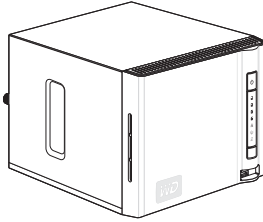

WD ShareSpace with four
or two drives

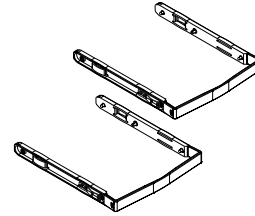

Drive mounting rails
(only included with two-drive systems)

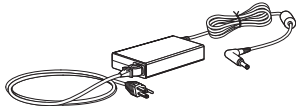

AC adapter
and power cords

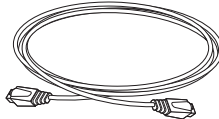

Ethernet cable



Installation CD with
application software
and user manual



Quick Install Guide

Accessories

Visit shopwd.com (U.S. only) to view additional accessories like cables, power supplies, additional hard drives, and drive mounting rails for this product. Outside the U.S., visit support.wdc.com.

System Requirements

For optimum performance, the following system and network requirements are recommended. Compatibility may vary depending on user's hardware configuration and operating system.



.....
Important: For highest performance and reliability, it is recommended that you install the latest updates and service pack (SP). For Macintosh, go to the **Apple** menu and select **Software Update**. For Windows, go to the **Start** menu and select **Windows Update**.

Client computer

- Ethernet connection (network adapter)
- Operating system
 - Windows 2000/XP/Vista/Server 2003
 - Mac OS X Tiger or Leopard
- Web browser (Internet Explorer 6.0 SP1 and later on Windows platforms supported by this product, Safari 2.0 and later on Mac platforms supported by this product, Firefox 2.0 and later on supported Windows and Mac platforms)
- Adobe Flash ActiveX 9 or higher (required for WD Discovery™)

Local network

- Router/switch (Gigabit required to maximize performance)

Wide Area Network

- Broadband Internet connection required for remote access using MioNet

Pre-installation

Before unpacking and installing the system, select a suitable site for the system for maximum efficiency. Place the device in a site that is:

- Near a grounded power outlet
- Clean and dust free
- On a stable surface free from vibration
- Well-ventilated and away from sources of heat
- Secluded from electromagnetic fields from electrical devices such as air conditioners, radio, TV transmitters.

Recording Your WD Product Information

In the following table, write the serial number and model number of your new WD product found on the label on the bottom of the device. Also, write the purchase date and other notes such as your operating system and version. This information is necessary for setup and technical support.

Serial Number:
Model Number:
Purchase Date:
System and Software Notes:

System View

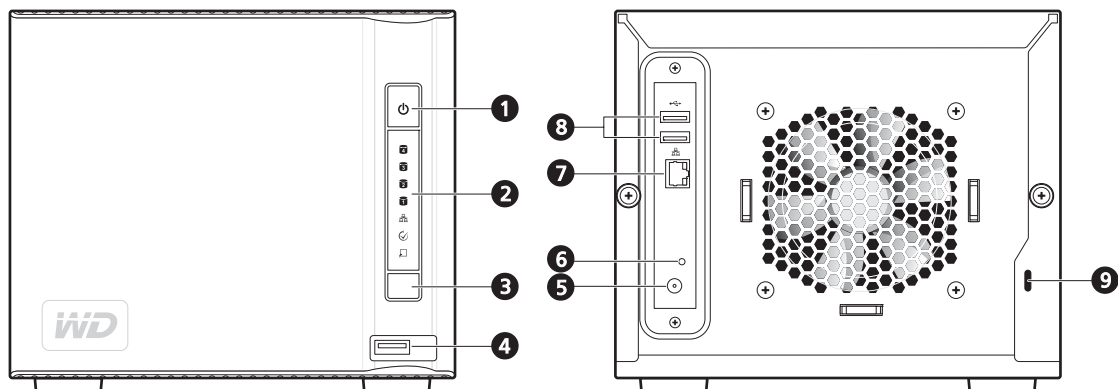

- | | | | |
|---|--------------------------|---|---------------------------|
| 1 | Power button | 5 | Power port |
| 2 | LED indicators | 6 | Reset button |
| 3 | USB backup button | 7 | Ethernet port |
| 4 | USB port 1 (Auto-backup) | 8 | USB ports 2 and 3 |
| | | 9 | Kensington® security slot |

Power Button













Important: The device powers on automatically upon initial connection to power, which may take up to three minutes. During this time, do not press the power button.

The power button turns the device on or off. To turn on the device, press the power button and hold down until the LED flashes once, then release. The LED remains off (up to 30 seconds) as the device powers up. Holding the button down for four seconds powers off the device.

LED Indicators





The LED (light-emitting diode) indicators on the device provide information about the status of the system, its hard drives, and network connection. The LEDs on the system indicate the following:

Indicator and icon	Color	State	Description
Power 	Green	Steady	System is powered up (connected to the power supply and turned on) and ready for use.
		Off	System is not powered on
		Flashing	<ul style="list-style-type: none"> System is booting System is restoring to factory default System is configuring RAID on the hard drive(s) System is configuring RAID 0, Span, or RAID 5 on a volume User volume is not available
Hard drives    	Green	Random flashing	Hard drive is in use
		Steady	<ul style="list-style-type: none"> Hard drive is ready for use Hard drive is installed
	Amber	Steady	<ul style="list-style-type: none"> Hard drive error
	Green/ Amber	Flashing	<ul style="list-style-type: none"> System detects a foreign hard drive with pre-existing data
	Green/ Amber	Off	<ul style="list-style-type: none"> Hard drive is not present Hard drive is not properly installed
Ethernet (front) 	Green	On	Network link is detected
		Off	No network connection
		Flashing	Transmit or receive activity
System identification /error 	Blue	On	System identification is active
		Off	System identification is disabled
	Red	Flashing	Critical condition
USB backup  	Green	Steady	<ul style="list-style-type: none"> A USB storage device is connected to the front USB port RAID system is rebuilding Restoring configuration settings System initialize operation in progress
		Flashing	<ul style="list-style-type: none"> One flash per second—system is formatting a USB drive One flash per second (backup)—USB device to WD ShareSpace Two flashes per second (backup)—WD ShareSpace to USB device
		Off	<ul style="list-style-type: none"> System initialize operation completed
Ethernet (rear) 	Orange	Flashing	<ul style="list-style-type: none"> Network is connecting Link activity
	Green	Steady	Network is connected
		Flashing	Network connection is active

USB Backup Button

The USB backup button allows you to back up data from a USB drive to the device or from the device to a USB drive. The USB backup feature only works on the front USB port (port 1). See “USB Auto Backup Feature” on page 60 for detailed instructions.

Ports

Component	Icon	Description
USB port 1		Connects to a USB drive. <i>Note:</i> This port has an auto-backup feature that makes it possible to automatically create backups of digital files from a USB drive to the device and vice-versa.
USB ports 2 and 3		Connects to a USB drive.
Ethernet port		Connects the device to a local network.
Reset button		Restores the admin user name and password for the device.
Power port		Connects the device to an AC adapter and the power outlet.

Reset Button

The reset button restores configuration settings such as the machine name, network mode/IP address, and admin password to default factory settings without erasing shared folders and volumes. For more information on how to reset the system, see “Resetting the WD ShareSpace” on page 151.

Kensington Security Slot

For drive security, the device is equipped with a security slot, which supports a standard Kensington security cable. For more information on the Kensington security slot and available products, visit www.kensington.com.

2

WD ShareSpace Basic Setup

Step 1: Connect WD ShareSpace to the Network

Follow the steps below to connect the WD ShareSpace to a small home/office network.

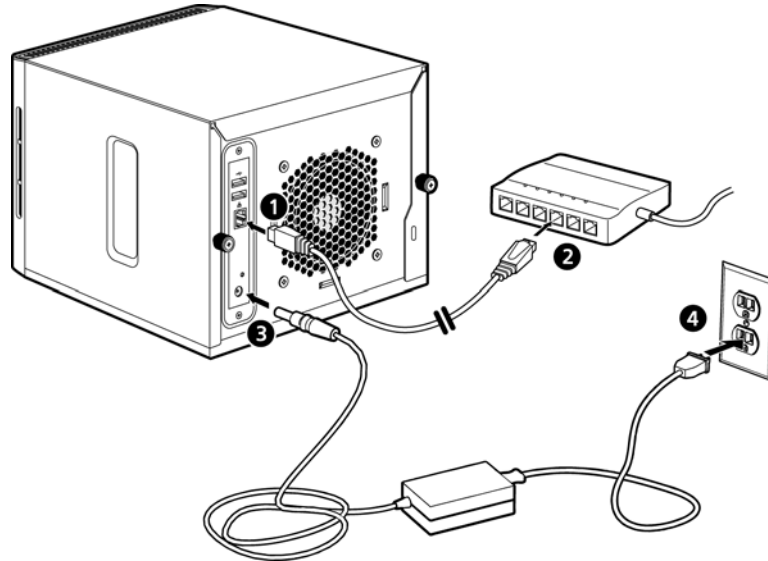

1. Connect one end of the Ethernet cable into the Ethernet port located on the back of the device.
2. Connect the other end of the Ethernet cable directly into a router or network switch port.
3. Connect the end of the adapter into the DC power supply socket located on the back of the device.
4. Plug the AC adapter into a power outlet. The unit powers up automatically after approximately 30 seconds indicated by a steady green LED illuminated on the power button.



.....
Important: Wait for the WD ShareSpace to finish powering up (approximately three minutes) before configuring the device.

To power down the device, press and hold down the power button down for at least four seconds.

Step 2: Access WD ShareSpace on the Network

You can easily find your WD ShareSpace on the local area network (LAN). Follow the appropriate procedure below:

- Windows 2000/XP/Vista on page 10
- Rally (Windows Vista) on page 11
- Macintosh Leopard on page 20
- Macintosh Tiger on page 24

WD Discovery

The WD Discovery application on the included CD should be installed on every PC connected to the LAN from which you intend to access your WD ShareSpace.

Windows 2000/XP/Vista/Server 2003

1. Turn on your computer and wait for the operating system to load.
2. Insert the software-installing CD into the CD or DVD ROM drive.



.....
*Note: If AutoPlay is disabled on your computer, you must install the utilities manually. Click **Start** and then **Computer** (Windows Vista) or **My Computer** (Windows 2000/XP). Right-click the CD/DVD drive, click **Open**, and double-click **Setup.exe**.*

3. *Windows Vista:* Click **Run setup.exe**, then click **Allow**.
4. Click **Accept** in the Terms of Agreement screen.



- If you have connected the WD ShareSpace properly as shown in the Connect screen, click **Next**.

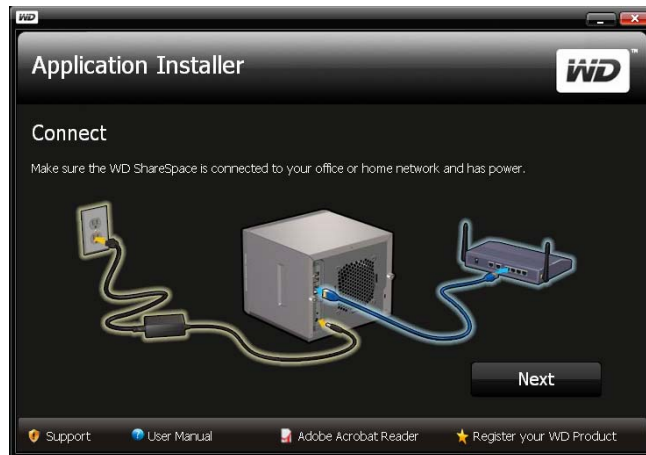

- The Application Installer screen opens, displaying a list of options. Click **WD Discovery Tool**. Once the WD Discovery Tool installation is complete, it will automatically launch and the WD Discovery icon will display on your desktop.
- The WD Discovery screen appears. Click **WDShareSpace** in the Network Drives Found list and click **Configure**.
- The login page appears. Continue device setup by following the instructions for “Setting Up the Device” on page 71.

Other Access Methods

Rally (Windows Vista)

Rally is a technology that comes with Vista and offers an alternative for easy setup and mapping of the WD ShareSpace without using WD Discovery.

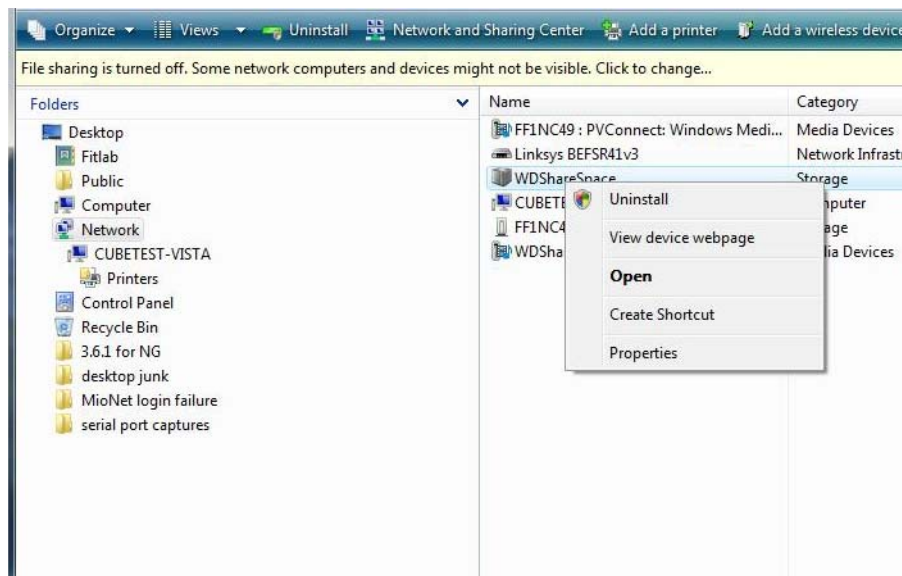

To open the WD ShareSpace shares:

1. Right-click **WDShareSpace** and click **Open**. The Public, Private, and Download shares (default shares) display.

To view the WD ShareSpace web page:

1. Right-click **WDShareSpace** and click **View device webpage**. The login page appears. (See “Accessing WD ShareSpace’s Network Storage Manager” on page 74 for information on logging in.)

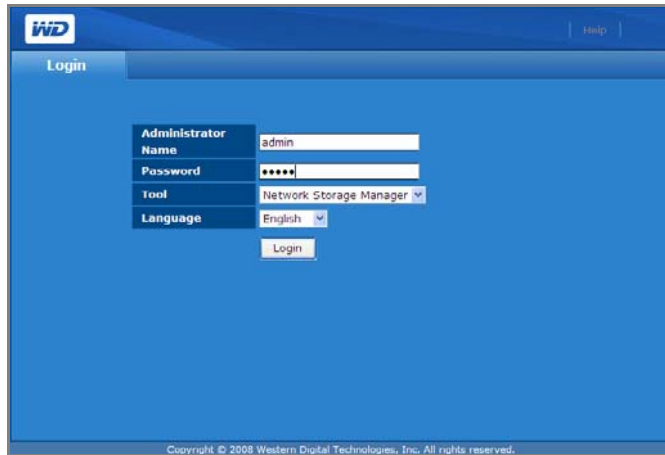

To create a shortcut to the WD ShareSpace:

1. Right-click **WDShareSpace** and click **Create Shortcut**.



.....

Note: Create a WD ShareSpace icon on your desktop by installing a driver. Insert the WD ShareSpace CD and right-click the WD ShareSpace icon in My Computer. Click **Open > WD_Windows > Tools > WD_Rally_Drivers > PnPxNas-4NC**. Right-click PnPXNas-4NC.in and click **Install**.

To view the properties of the WD ShareSpace:

1. Right-click **WDShareSpace** and click **Properties**.

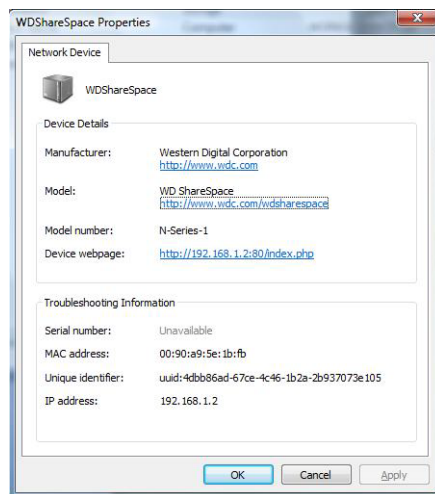

To uninstall:

1. Right-click **WDShareSpace** and click **Uninstall**.

Macintosh Leopard

1. Turn on your computer and wait for the operating system to load.
2. In Finder, double-click **WDSHareSpace** in the Shared list (if necessary, click **All** then double-click **WDSHareSpace**).
3. If the connection fails, click **Connect As** on the WDSHareSpace screen that appears.
4. On the login screen, type “admin” in both the **Name** and **Password** fields and make sure the **Remember this password in my keychain** check box is selected. Click **Connect**.



5. Double-click the Public icon to display the subfolders: Shared Music, Shared Pictures, and Shared Videos.

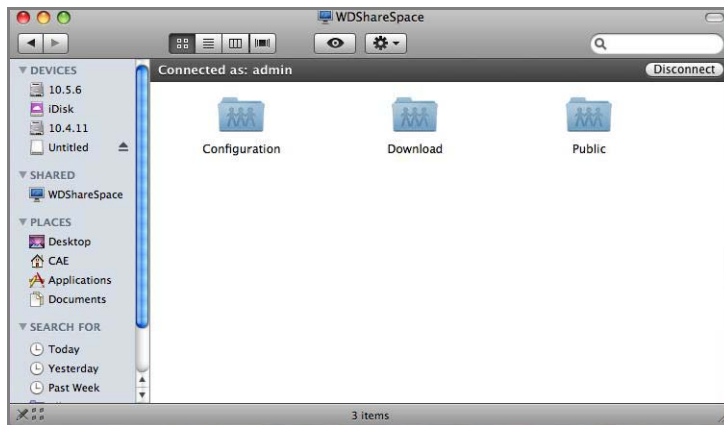

.....
Note: Configuration is a read-only share containing only a Help file and the login page.

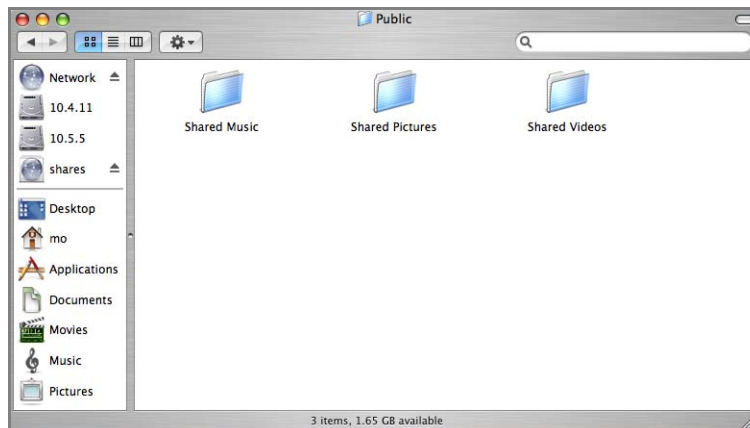

You can now drag and drop files into the shared folders using Finder.

6. To make the shared drive icon permanent on your desktop, create an alias:



.....
Note: Before creating an alias, click **Finder>Preferences** and make sure **Connected Servers** is checked.

- (a) Double-click the item you want to alias (e.g., the Public share icon), and click one of the subfolders.
- (b) Click **File>Make Alias**.



The Public share icon displays on your desktop.



Macintosh Tiger

1. Turn on your computer and wait for the operating system to load.
2. On the menu bar, click **Go>Connect to Server**.

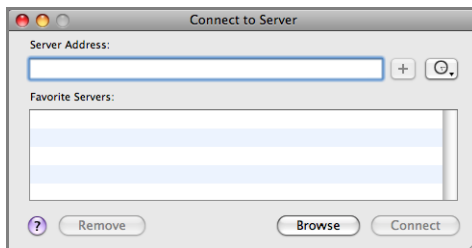

3. Click **Browse** and double-click the WD ShareSpace.
4. On the Connect to Server screen, click **Connect**.

5. Type "admin" in both the **Name** and **Password** fields and select the **Remember this password in my keychain** checkbox. Click **OK**.



6. Double-click **WDSHareSpace**.

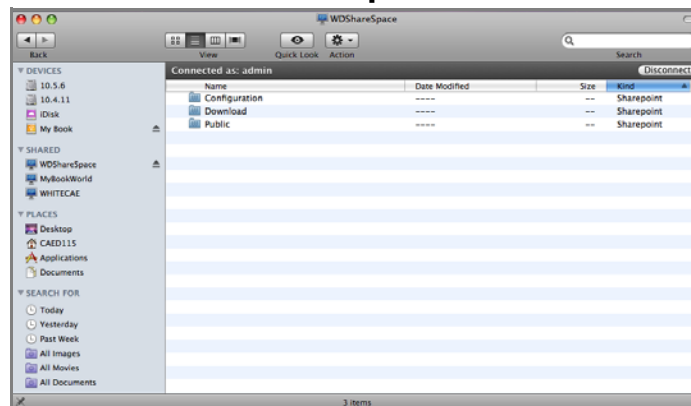

7. In the left pane, under **Shared**, double-click **Public** to display the Public subfolders (Shared Music, Shared Pictures, and Shared Videos).
You can now drag and drop files into the shared folders using Finder.
8. The share appears as a shared drive icon on the desktop depending on your preferences. To make the shared drive icon permanent on your desktop, create an alias:



.....
Note: Before creating an alias, click **Finder>Preferences** and make sure **Connected Servers** is checked.

- (a) Click the item you want to alias (for example, **Public**).
- (b) While holding down the **Ctrl** or **Cmd** key and the **Option** key simultaneously, drag the item to where you want the alias to appear. The alias appears at the new location.



Congratulations!

Your WD ShareSpace is now ready for use and is accessible as a drive letter in My Computer (Windows) or a shared drive icon on the desktop (Macintosh). You can now drag and drop files into your WD ShareSpace and move files from your WD ShareSpace to any computer in your network that has been set up according to the instructions above.

This user manual contains information and instructions for all other basic and advanced WD ShareSpace device management functions, including:

- Backing up your computer (see “Backing Up Computers on a Network” on page 18)
- Accessing WD ShareSpace from a remote computer (see “MioNet Remote Access” on page 41)
- Playing and streaming media (see “How to Play/Stream Video, Music & Photos” on page 51)
- Using iTunes service (see “Using iTunes with WD ShareSpace” on page 58)
- Connecting a USB drive for additional storage and file exchange (see “External USB Drive Sharing & Backup” on page 60.)
- Configuring the WD ShareSpace device and network settings, set e-mail or window alerts, change the administrator password, perform firmware upgrades, restore system to factory defaults, configure RAID, manage file share preferences, set the backup destination folder, set disk quotas, set a share folder for users, add, modify, and delete users and groups, and change all user and group permissions (read/write, read only, no access) to shares/folders and USB storage devices (see “Network Storage Manager: Basics” on page 69 and “Network Storage Manager: Advanced” on page 87).

WD ShareSpace File Storage

You can access and store content on WD ShareSpace via network shares. Shares are folders that can be used to organize and store files on your WD ShareSpace. Shares can be shared with everyone (public) or with selected users on your network (private).

The device comes preconfigured with three shares:

- **Public**—created automatically after initial setup
 - Shared Music - folder for storing music files you want to share with other users.
 - Shared Pictures - folder for storing image files you want to share with other users.
 - Shared Videos - for storing video files you want to share with other users.



.....

Important: Do not change or delete these default share folders. Disruption of file sharing could result. These are the default folders for the Media Server (Twonky Media) and iTunes Service. For more information on how to use Twonky media, see “How to Play/Stream Video, Music & Photos” on page 51. For more information on how to use the iTunes service, see “Using iTunes with WD ShareSpace” on page 58.

- **Download**—for saving files using Downloader (see “Scheduled Downloads” on page 141).
- **Configuration**—this is a read-only share containing only a Help file and the login page. It is not meant for sharing or storing data and should not be modified.

3

Backing Up Computers on a Network

WD Anywhere Backup Overview

WD Anywhere Backup software is a quick and easy and secure way to back up all the computers in your network. Your WD ShareSpace Installation CD comes with five licenses for WD Anywhere Backup—each one enabling you to activate a single PC or Mac for continuous backup. Select the files you want to back up, and then set the WD ShareSpace and forget it; every time you save a change it's automatically backed up.

Installing WD Anywhere Backup

Important Notes for Installing WD Anywhere Backup

Install on Each Computer: You must use the Installation CD to install WD Anywhere Backup on each computer in your network.

Install on the LAN and Power On First: You must have your WD ShareSpace connected to your local area network and powered on before you install WD Anywhere Backup software. This will ensure that the WD Anywhere Backup recognizes your WD ShareSpace and will install as the full software version instead of the 30 Day trial version.

Laptop Users: When you are traveling, your laptop files will not be backed up. If you want to have your files automatically backed up upon reconnection with your home network, you must set your passwords on your laptop and your WD ShareSpace to be the same. Otherwise, you will have to log in to your WD ShareSpace every time you reconnect to your home network before WD Anywhere Backup will begin to back up your files.

Windows

1. Turn on your computer and wait for the operating system to load.
2. Insert the software CD into the CD-ROM drive.



.....

*Note: If AutoPlay is disabled on your computer, you must install the utilities manually. Click **Start** and then **Computer** (Windows Vista) or **My Computer** (Windows 2000/XP). Right-click the CD/DVD drive, click **Open**, and double-click **Setup.exe**.*

3. *Windows Vista:* Click **Run setup.exe** and then click **Allow**.
4. Click **Accept** in the Terms of Agreement screen.
5. If you have connected the device properly as shown in the Connect screen, click **Next**.
6. Click **WD Anywhere Backup**.

2. WD Anywhere Backup



Note: It may take a minute or two for the next screen to display.

7. Select your preferred language from the list and click **OK**.

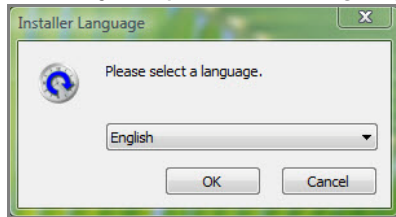

8. Close all other open applications, and then click **Next** to continue.



9. If you accept the terms of the agreement, click **I Agree** to continue.

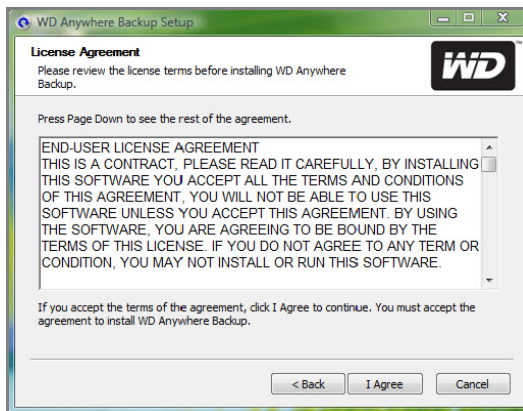

10. After WD Anywhere Backup has finished installing, click **Finish** to begin using WD Anywhere Backup.

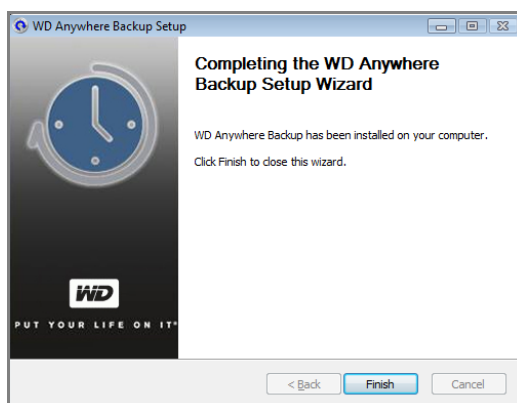

The WD Anywhere Backup Configuration screen appears. Continue with “One-Click Backup” on page 24.

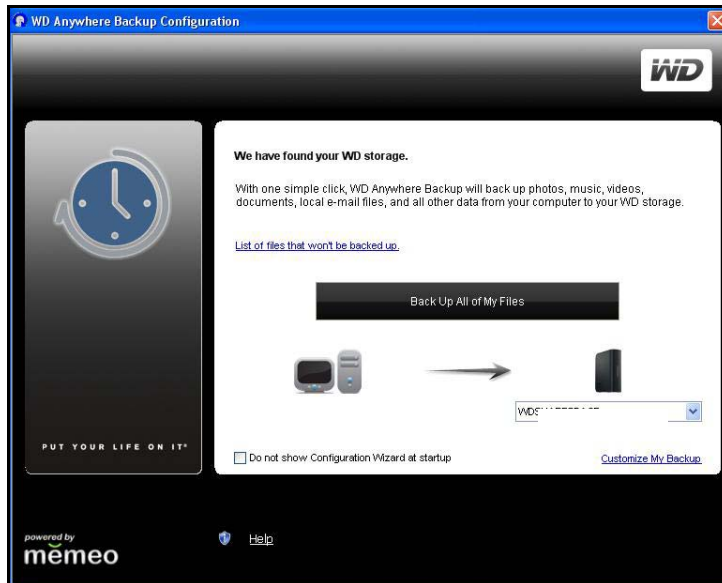

Note: The **WD Anywhere Backup** icon now appears on your desktop, and WD Anywhere Backup is listed in Program Files.

Macintosh Leopard or Tiger

1. Turn on your computer and wait for the operating system to load.
2. Double-click the WD ShareSpace icon on the desktop.



3. Double-click **WD_Anywhere_Backup.dmg**.

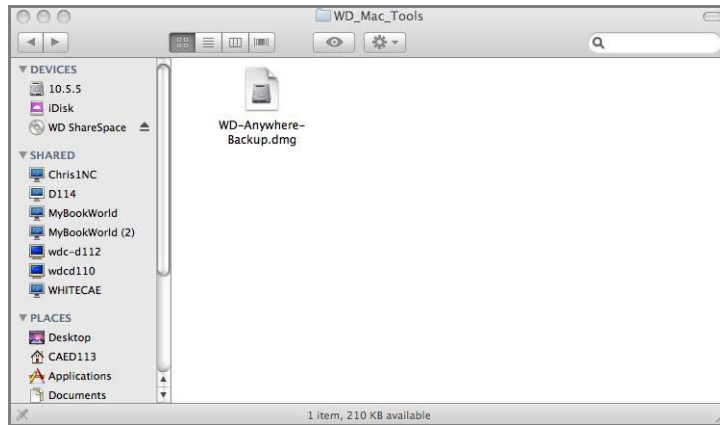

4. On the WD Anywhere Backup screen, click the WD Anywhere Backup icon.



5. On the verification dialog box, click **Continue**.

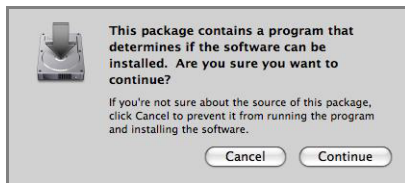

6. On the first screen of the Install WD Anywhere Backup wizard, click **Continue**.



7. On the Software License Agreement screen, click **Continue**.

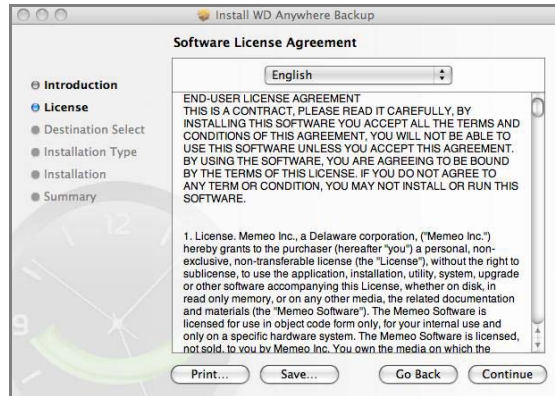

8. To accept the software license agreement, click **Agree**.

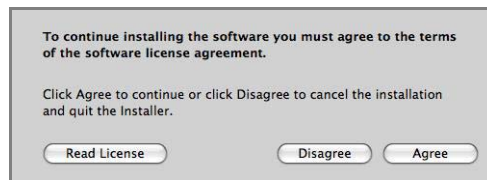

9. Click **Install**.

10. Enter your Mac user name and password.



11. When a screen verifying successful installation appears, click **Close**.



12. Now you can begin backing up your data. Click **+ > Create Backup Plan**.

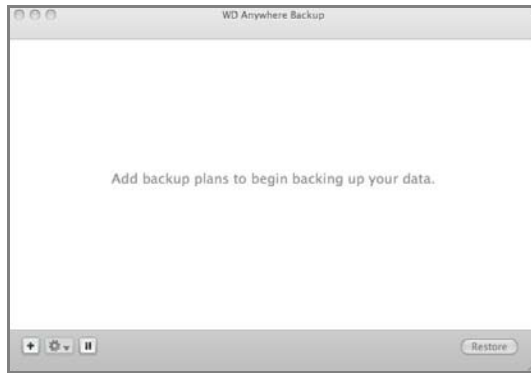

Configuring WD Anywhere Backup

One-Click Backup

WD Anywhere Backup allows you to back up all your important data, such as documents, photos, music and videos, on your computer's hard drive with the click of a button. This feature backs up your data to the WD ShareSpace so you can restore your data in the event that your computer's hard drive crashes.

The first time you install WD Anywhere Backup, the WD Anywhere Backup Configuration screen appears.



.....
Note: The screen below only appears when you have WD ShareSpace attached to your computer's local area network.

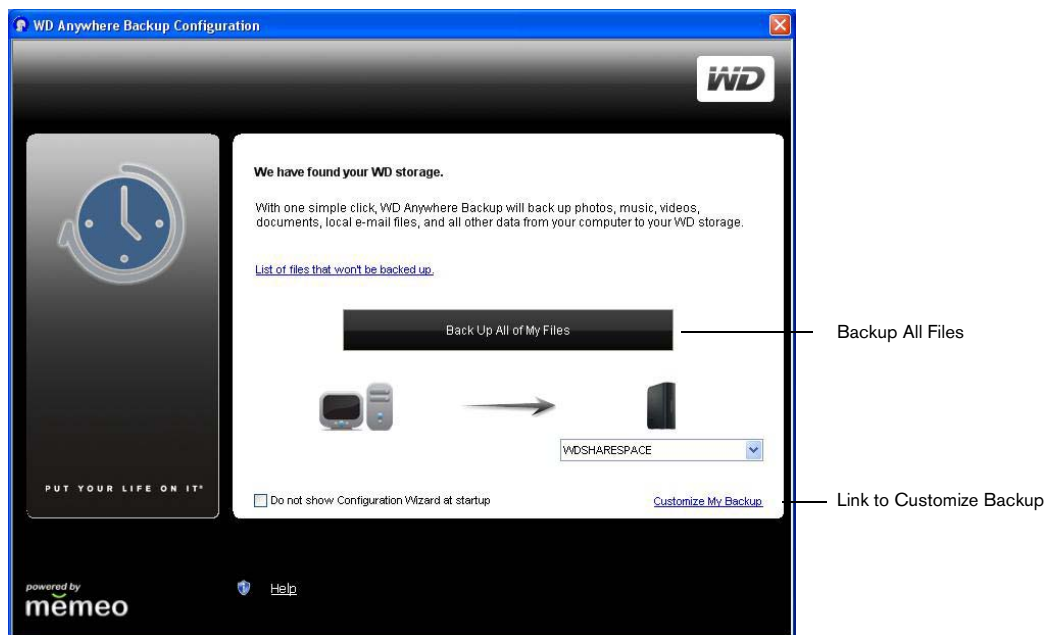

This screen offers two options:

Automatic Backup: The main option is to have the WD ShareSpace automatically and continuously back up your files, providing assurance that your files can always be restored.

What it backs up

One click backup backs up the main computer's c: drive on a PC.

What it does not back up

One click backup does not include files on the A: drive, application files such as MS Word or Adobe Acrobat, temporary and log files, virtual hard disk files, or files in the system folders.

Customized Backup: The other option is to customize your backup to back up only selected types of files, for example, only photos or videos, or other drives.

To start an automatic and complete backup of your computer's hard drive:

1. Click **Back Up All of My Files**.
2. A message explains that initial backup will use moderate resources on your computer. To pause the backup, click **Pause until System Idle**. To keep the backup running in the background, click **Continue**.



.....
Note: If you do not want these messages to display in the future, click **Do not show Configuration Wizard at startup**.

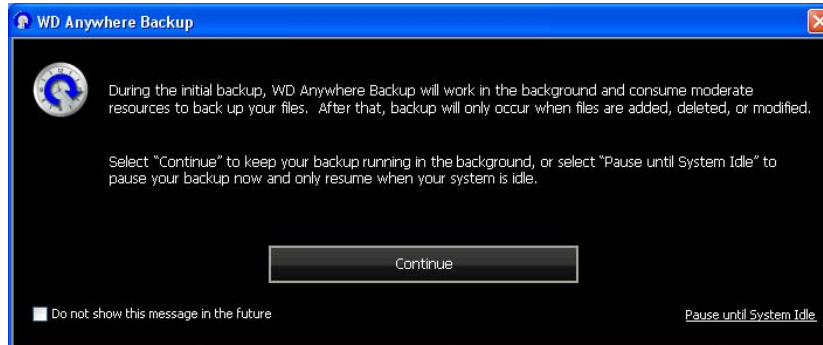

3. A registration screen appears. If desired, enter the optional registration information. Click **Continue**.

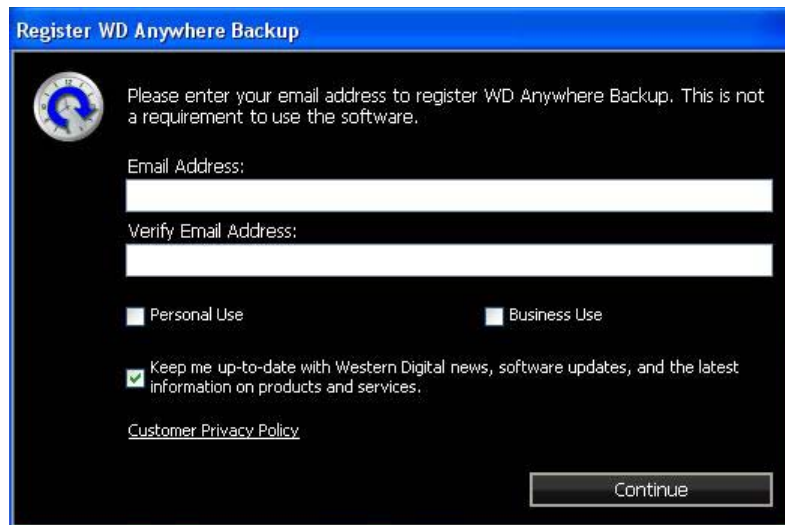

The WD Anywhere Backup screen displays the progress of the backup.

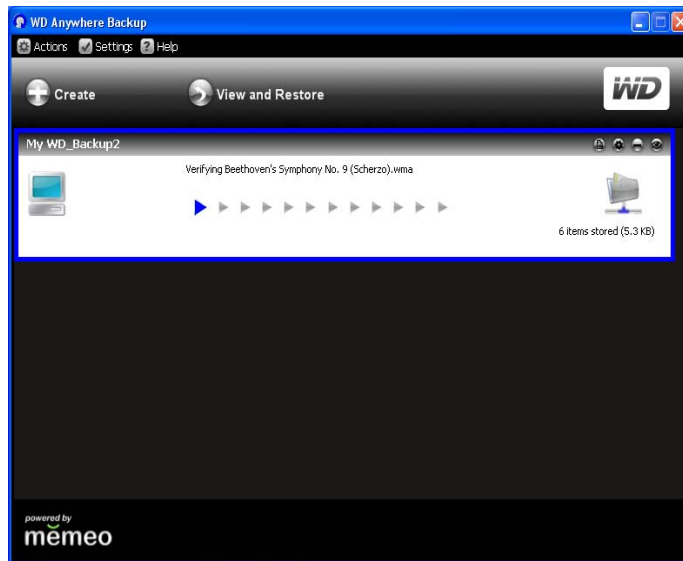

When the backup has finished, a backup complete message appears.

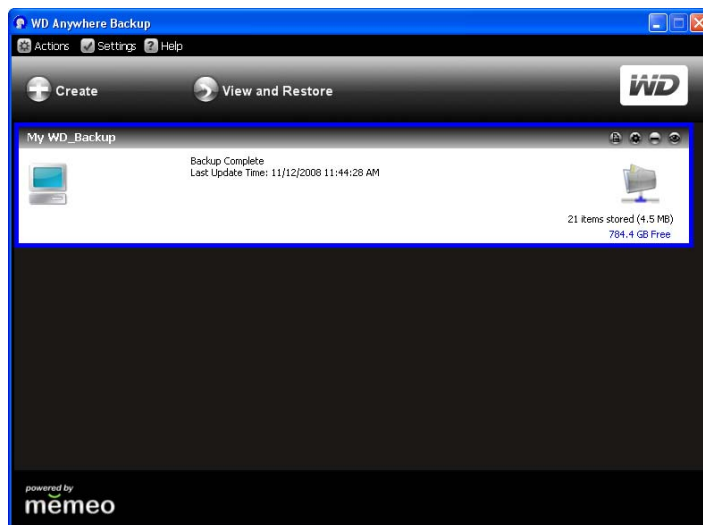

4. To create another backup, click **Create** and continue with step 3 in “Creating a Customized Backup Plan” on page 27. If not creating another backup, close the screen. The WD Anywhere Backup icon appears in the system tray.

To customize a backup plan:

1. Click the **Customize My Backup** link at the bottom right of the WD Anywhere Backup Configuration screen. The Welcome to the WD Anywhere Backup Wizard screen appears.
2. Continue with step 3 in “Creating a Customized Backup Plan” on page 27.

Creating a Customized Backup Plan

Creating and customizing a backup plan gives the advanced user complete control over which files are backed up.

1. If WD Anywhere Backup is not already running, click the WD Anywhere Backup icon on the desktop.
2. Click **Create**. (If the screen shows no backup plans, none have been created.)

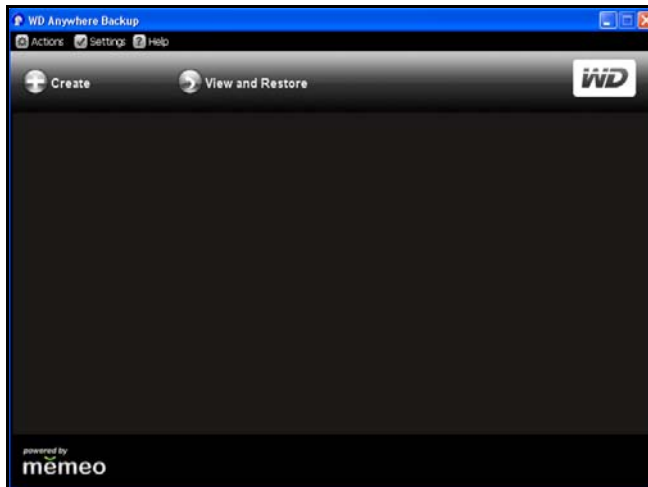

3. The welcome screen for customizing your backup appears. Click **Next**.

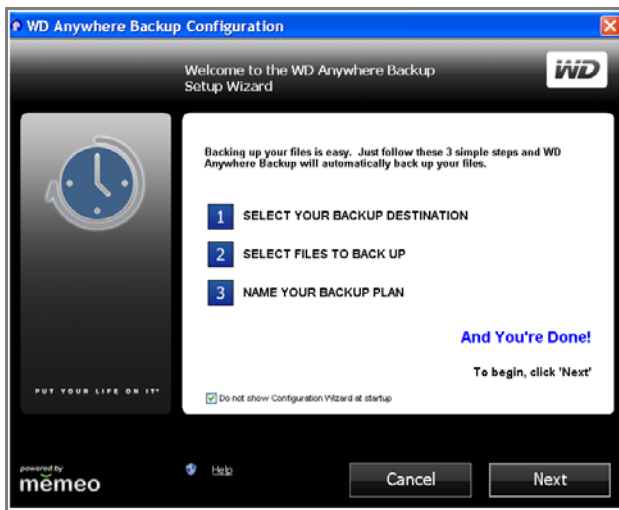

4. Click **Network Places** and locate your WD ShareSpace on your local area network. Click **Next**.

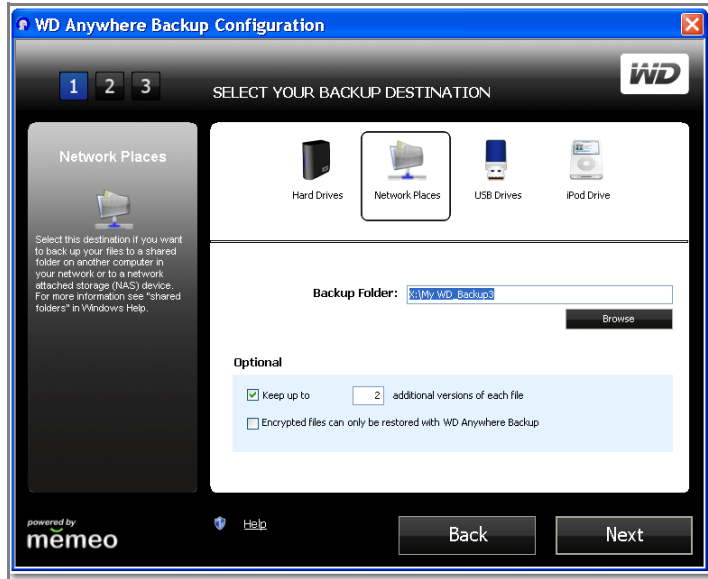

The Select Items to Back Up screen displays.

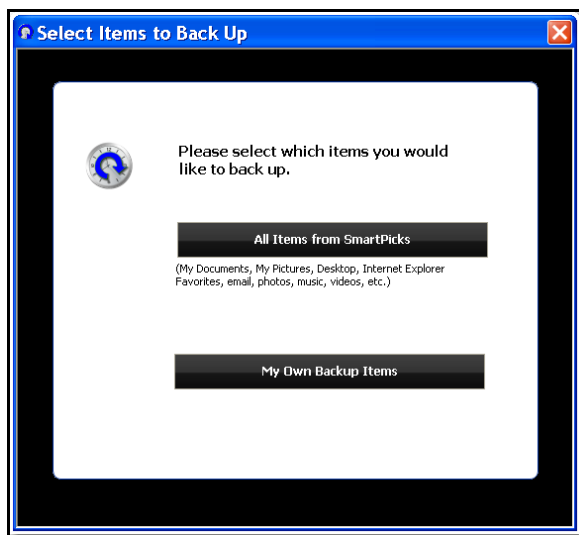

You have two options:

To select all items, see “Selecting all items from SmartPicks” on page 29.

To select specific items, see “Selecting your own backup items” on page 31.

Selecting all items from SmartPicks

All Items from SmartPicks

1. Click the **All Items from SmartPicks** button. The SmartPicks screen displays, listing common file types that you can back up.



2. Select each file type you want to back up. You can also click **Select None** to clear all selections, or click **Select All** to select all of the items.
3. To add more items, click the **Add Backup Items** button. The Local Folders tab displays. Select additional folders and click **Select**.

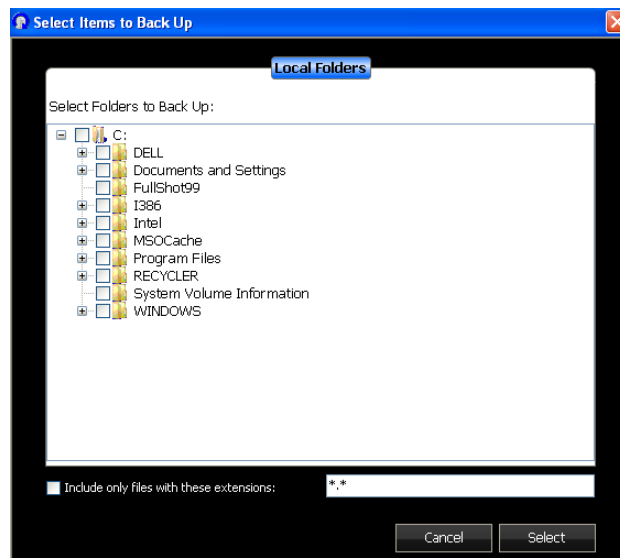

4. To exclude more items from your plan:
 - (a) Click the **Show Advanced Items** button.

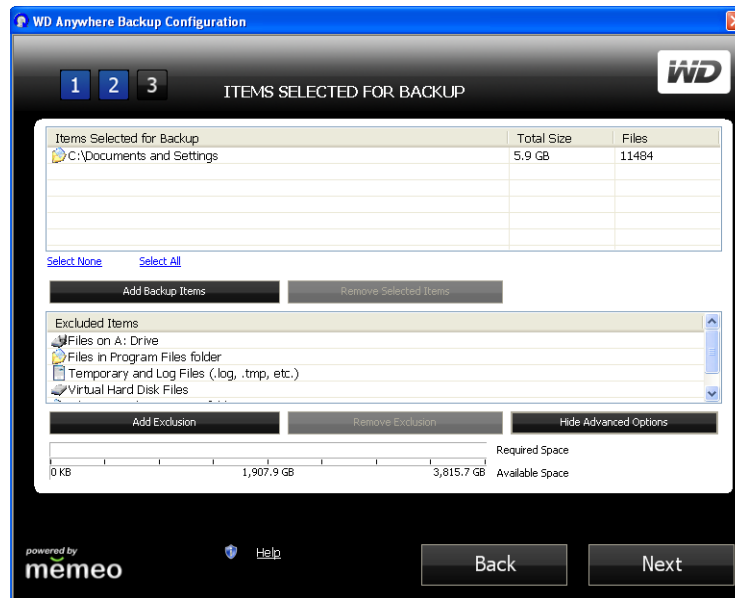

- (b) Click the **Add Exclusion** button.

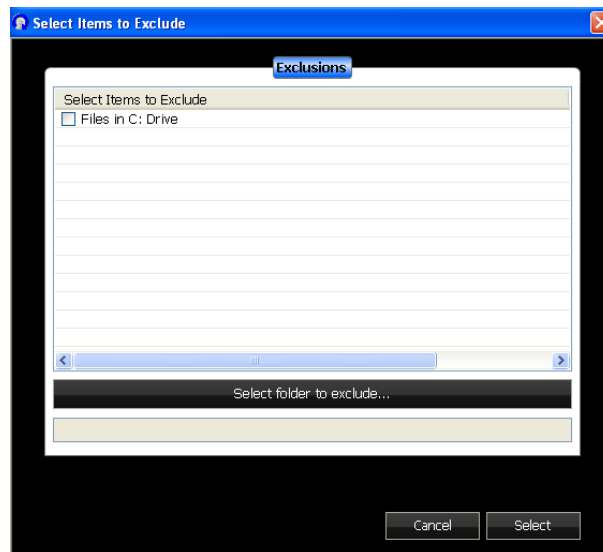

- (c) Select items to exclude from the backup plan, or click the **Select Folder to Exclude** and select any folders from the plan. Click the **Select** button.
5. On the Items Selected for Backup screen, click **Next** button.
6. Continue with “Completing the Backup Plan” on page 32.

Selecting your own backup items

My Own Backup Items

1. Click the **My Own Backup Items** button. The SmartPicks screen appears, listing default file locations you can back up.
2. You have two options:
 - (a) On the **SmartPicks** tab, select each item you want to back up. You can also click **Select None** to clear all selections, or click **Select All** to select all of the items. When finished, click **Next**.

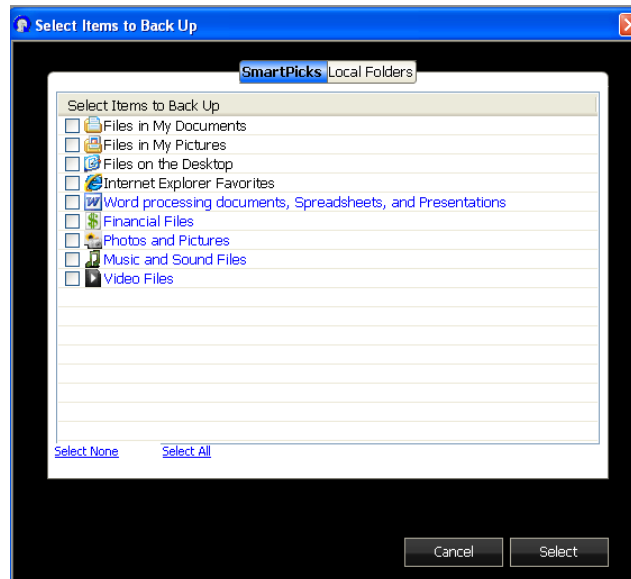

- (b) On the **Local Folders** tab, select each folder you want to back up and click **Select**.

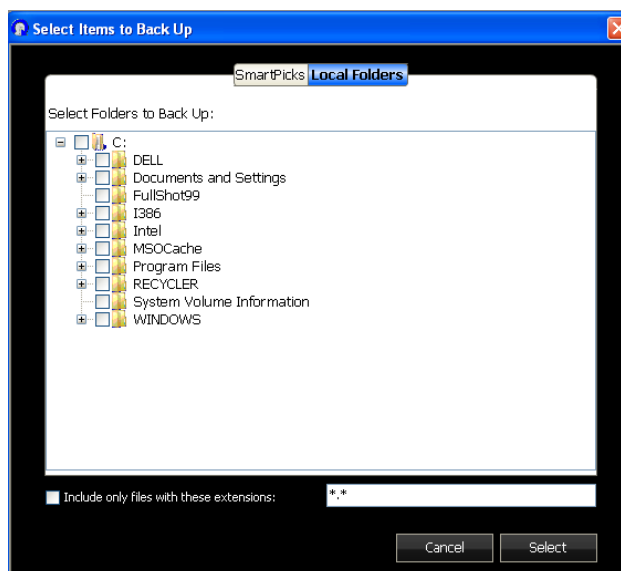

- On the Items Selected for Backup screen, you can add more items or use advanced items as described in “Selecting all items from SmartPicks” on page 29.

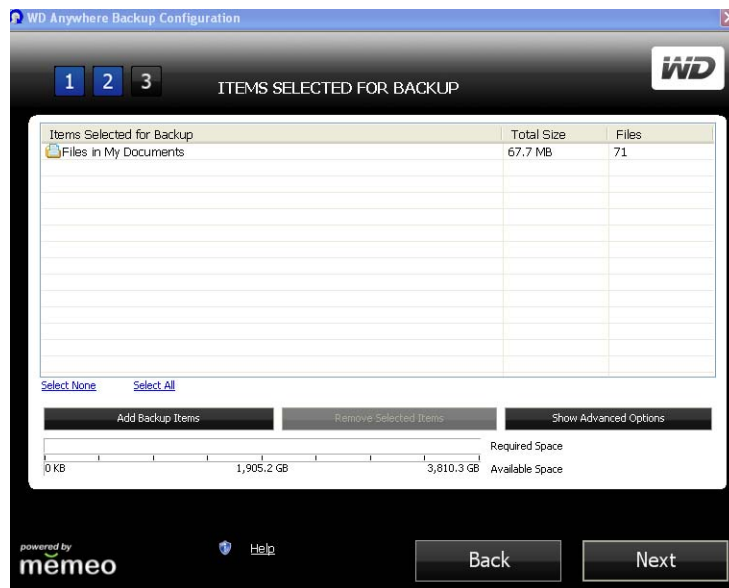

- On the Items Selected for Backup screen, click **Next** button.
- Continue with “Completing the Backup Plan” on page 32.

Completing the Backup Plan

- Name your backup plan and click **Next**. You can create additional backup plans by repeating the steps above.

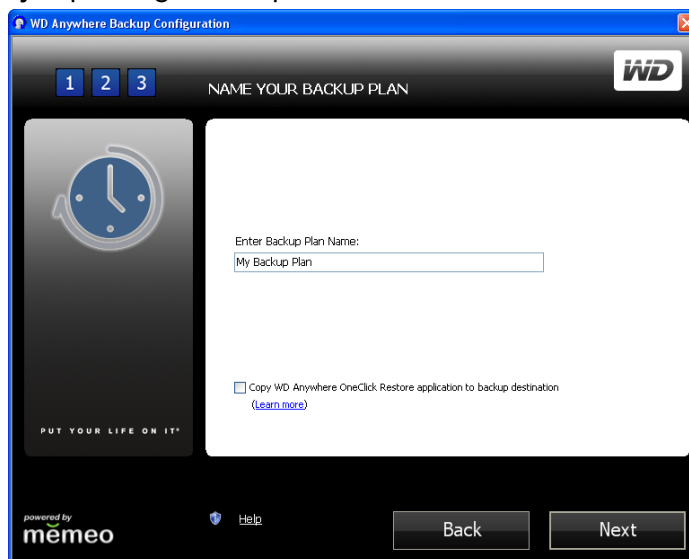

2. A confirmation screen appears. Click **Done**.

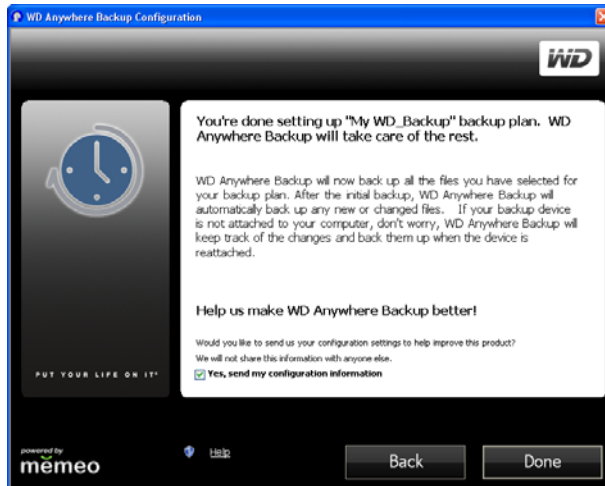

3. A message explains that initial backup will use moderate resources on your computer. To pause the backup, click **Pause until System Idle**.
4. To keep the backup running in the background, click **Continue**.

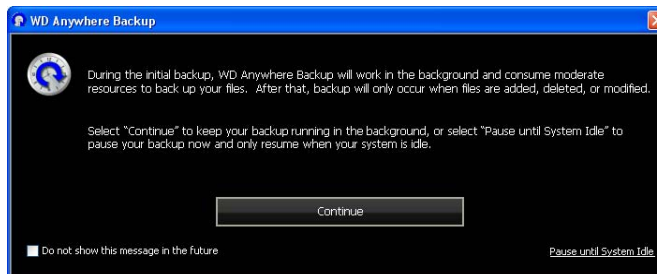

The WD Anywhere Backup screen displays the progress of the backup.

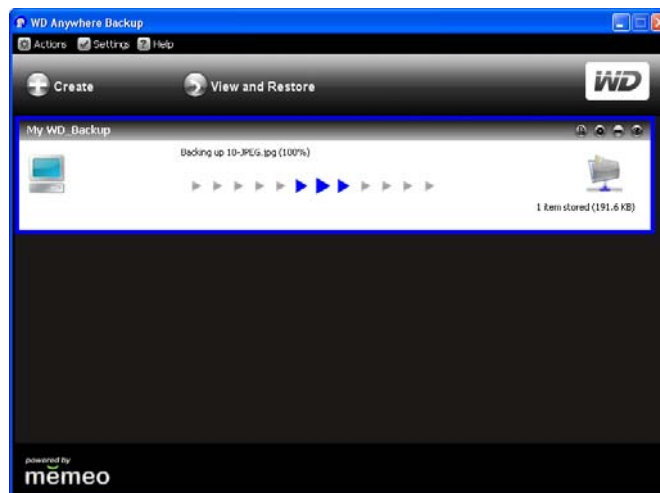

When the backup finishes, the Backup Complete screen appears.

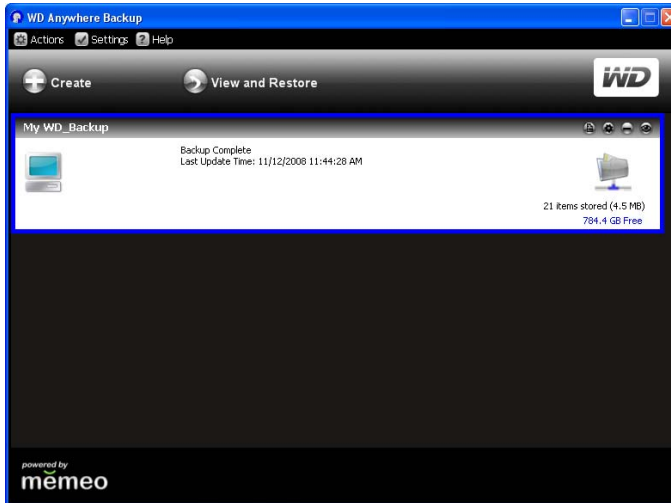

Alternatively, close the screen, click the WD Anywhere Backup icon, and select **Show backup status**.

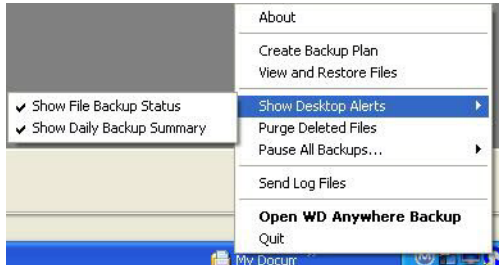

As files are backed up, a small notification window appears.

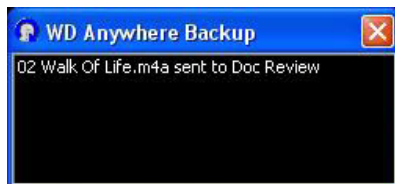

Restoring a Backup Plan

You can restore the files in your backup plan to a specified location in the event that you accidentally delete a file, want to compare file versions, or have lost all data due to a hard drive crash on your computer.

1. Click **View and Restore**.

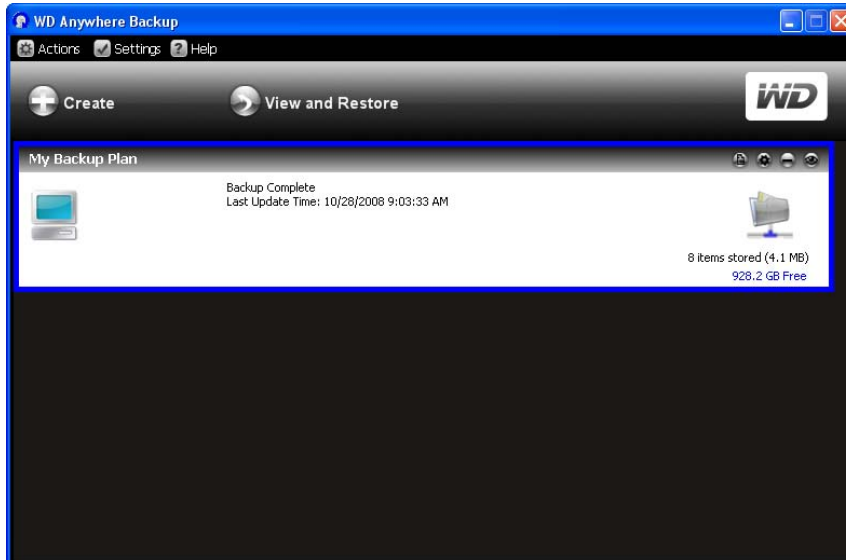

2. Click a backup plan in the **Select a Plan** list, or to search for a backup plan, enter the name in the **Search by File Name** field and click **Search**.
3. Click the box(es) next to the folders or files you want to restore.
4. From the **Restore Files to** list, select a location for your restored files and click the **Restore** button.

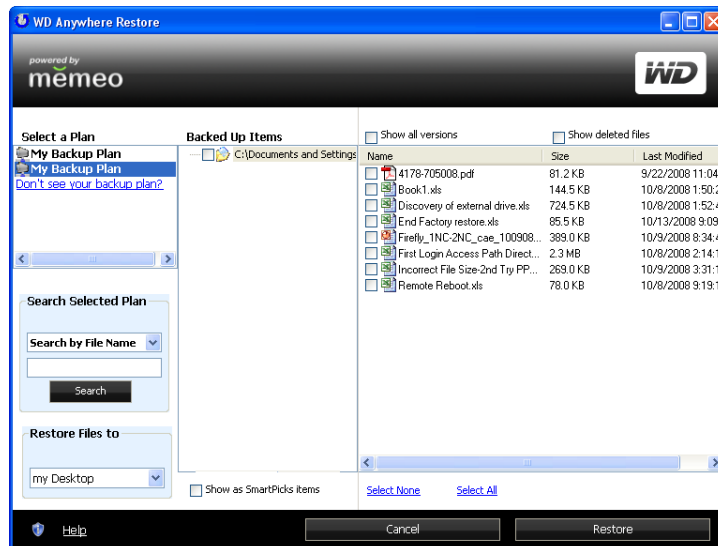

Reactivating a Backup Plan

You may reactivate an old backup plan if you want to continue backing up the files specified in that plan.

1. On the menu bar, click **Actions > Reactivate Backup Plan**.

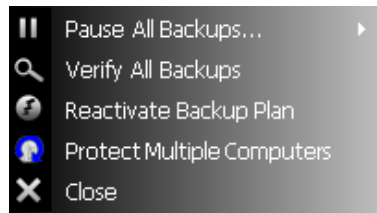

The Reactivate wizard appears.

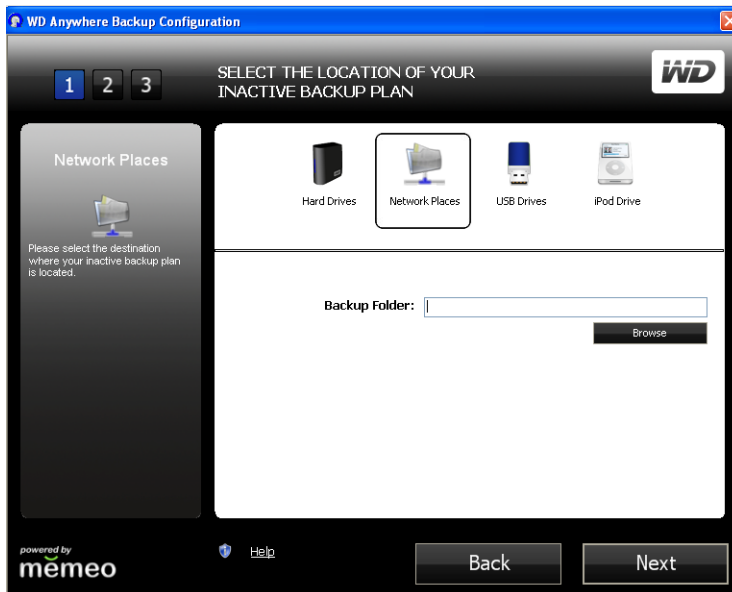

2. Browse to select the location of the backup folder and click the **Next** button.
3. If you have more than one backup plan, select the one you want to reactivate and click **OK**.

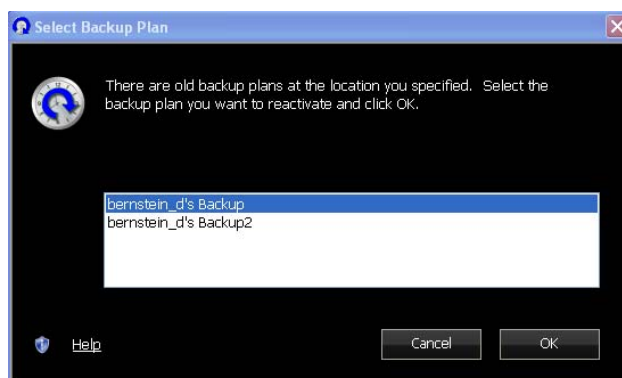

4. Select the **No, just reactivate the backup plan and start backing up** option and click the **Next** button. Your backup plan will be reactivated, and your computer will back up files onto your selected backup destination.



Important: If you select the **Yes** option, all the files in your backup up plan will be restored onto your computer. This will overwrite the files on your computer with the files from your backup plan. See “Restoring a Backup Plan” on page 35.

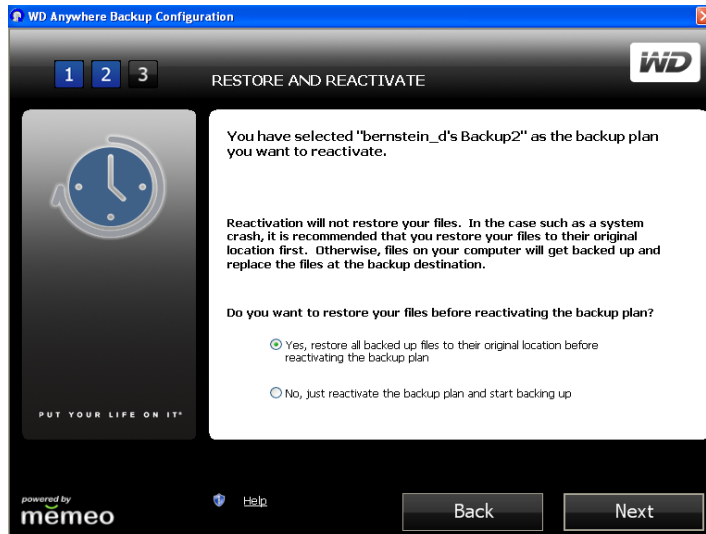

Editing a Backup Plan

Icons

Click the icons to add or remove files to and from backup plans, keep multiple revisions of files on hand for recall, remove entire plans, and view the backup log.

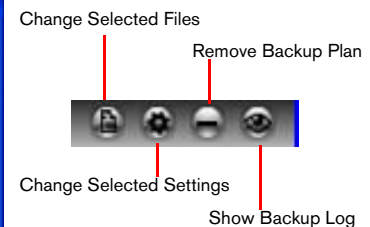
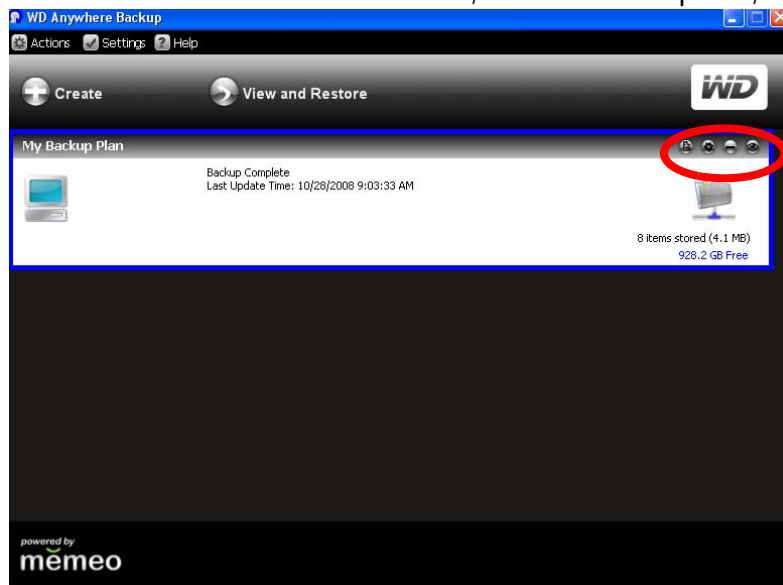

Selecting a Backup Plan

If you have more than one backup plan, select the one you want by clicking in its box. A blue border surrounds the selected plan.

Changing Selected Files

1. On the WD Anywhere Backup screen, click the Change Selected Files icon. (See “Icons” on page 37.) The WD Anywhere Backup Configuration screen appears.



Note: To deselect all listed files, click the **Select None** link. To select all the listed files, click the **Select All** link.

2. Do one of the following:
 - To add files, click the **Add Backup Items** button.
 - To remove files, select the files and click the **Remove Selected Items** button.
 - To exclude files from the backup, click the **Show Advanced Options** button.

Depending on your selections, subsequent screens may display.
3. When you finish selecting items to add or remove, click the **Select** (or **OK**, depending on the screen) button.
4. When returned to the WD Anywhere Backup Configuration screen, click the **Done** button.

Changing Backup Plan Settings

You can change the number of versions of the same files WD Anywhere Backup should keep. For example, you may want to keep yesterday’s version as well as today’s version.

1. Click the Change Selected Settings icon. (See “Icons” on page 37.) Select the **Keep up to** check box and enter the maximum number of earlier versions of your files to back up.

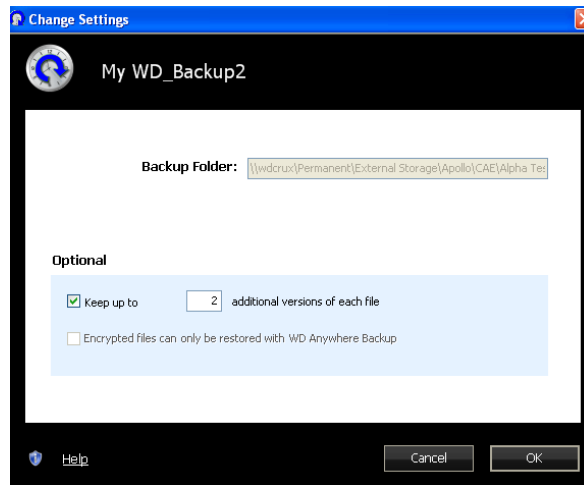

2. Click **OK**.

Removing a Backup Plan

You can delete a backup plan on the WD Anywhere Backup screen. Your backed up files remain at their destination until you delete them manually.

1. Click the Remove Backup Plan icon. (See “Icons” on page 37.)
2. In response to the confirmation message, click **OK**.

Showing the Backup and Error Logs

WD Anywhere keeps a log of all actions and backup errors.

1. Select the backup plan, and click the Show Backup Log icon. (See “Icons” on page 37.) The Backup Log appears.

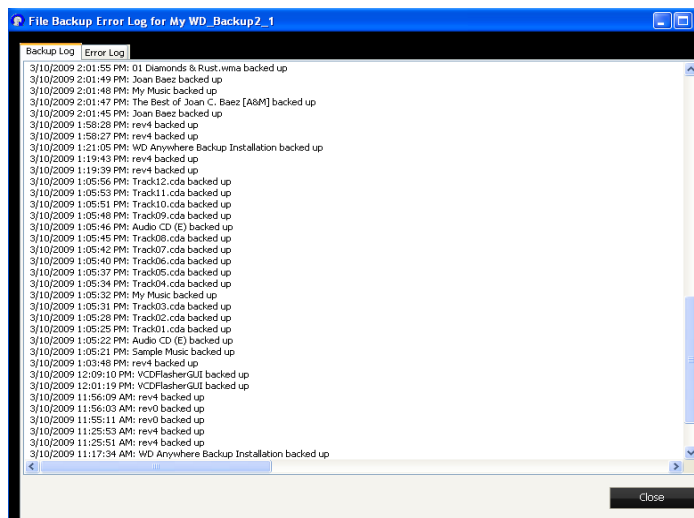

2. To view the error log, click the **Error Log** tab.

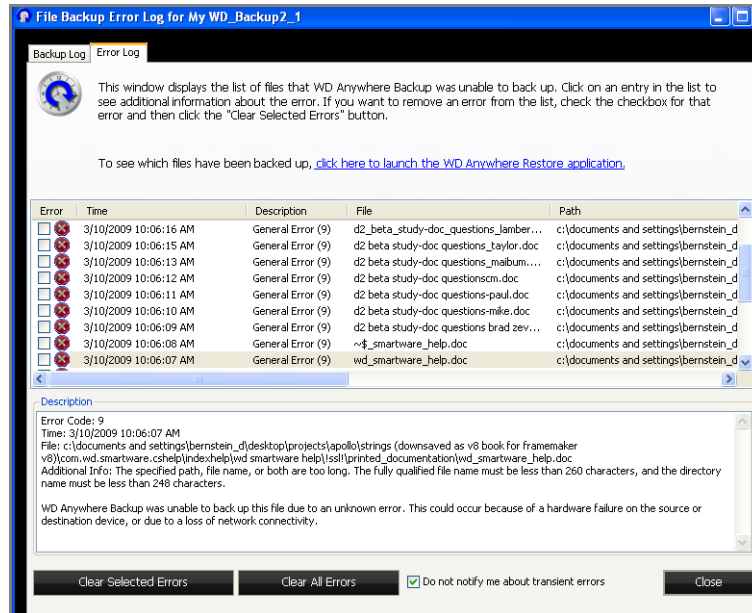

3. To see an explanation of an error in the list displayed in the lower part of the screen, click the error.
4. To clear selected errors, select their check box and click the **Clear Selected Errors** button.
5. To clear all errors, click the **Clear All Errors** button.
6. To prevent the Error Log from displaying transient errors, click the **Do not notify me about transient errors** check box. This selection affects all backup plans.
7. To see which files have been backed up, click the **click here to launch the WD Anywhere Restore application** link. (For information on restoring, see “Restoring a Backup Plan” on page 35.)

4

MioNet Remote Access

MioNet Overview

Access your photos, music, documents, and videos from anywhere, anytime using MioNet secure remote access services from WD. MioNet makes remote file access and sharing seamless, simple and very secure. Just follow the steps to register your WD ShareSpace into your secure MioNet account. Then you can access your content from any web browser in the world with your unique username and password.

MioNet also enables you to share a folder of pictures on your WD ShareSpace with friends (no upload required) or a folder of documents with your business colleagues. Invitees can view the content you share with them, but nothing else.

Remote Access Setup

WD ShareSpace comes with MioNet enabled by default. The **Remote Access** menu in WD ShareSpace's Network Storage Manager allows you to further control the MioNet service on the storage device. See "Remote Access" on page 85 for further details.

Windows

1. Turn on your computer and wait for the operating system to load.
2. Insert the WD ShareSpace software CD into the CD-ROM drive.



.....
*Note: If AutoPlay is disabled on your computer, you must install the utilities manually. Click **Start** and then **Computer** (Windows Vista) or **My Computer** (Windows 2000/XP). Right-click the CD/DVD drive, click **Open**, and double-click **Setup.exe**.*

3. *Windows Vista:* Click **Run setup.exe** and then **Allow**.
4. Click **Accept** in the Terms of Agreement screen.
5. If you have connected the device properly as shown in the Connect screen, click **Next**.

6. Click the **MioNet New Account** button if you are a new MioNet user; click **MioNet - Existing Account** if you are an existing user.



The MioNet registration screen appears.

7. Complete the registration form and click **Submit** to create an account.

8. When MioNet finds the WD ShareSpace you are registering, enter a name for the device and click **OK**.



9. A confirmation message appears. Click **OK**.

MioNet displays a list of the public folders stored on your WD ShareSpace and includes a private folder that was created with the MioNet username.

On login, MioNet searches for any unregistered WD ShareSpace units and gives any it finds a default name of WD Storage. MioNet names are independent of names assigned using WD ShareSpace's Network Storage Manager.

When in the same local network as WD ShareSpace, you cannot access the files and folders through MioNet. They are only available through MioNet from a remote location.

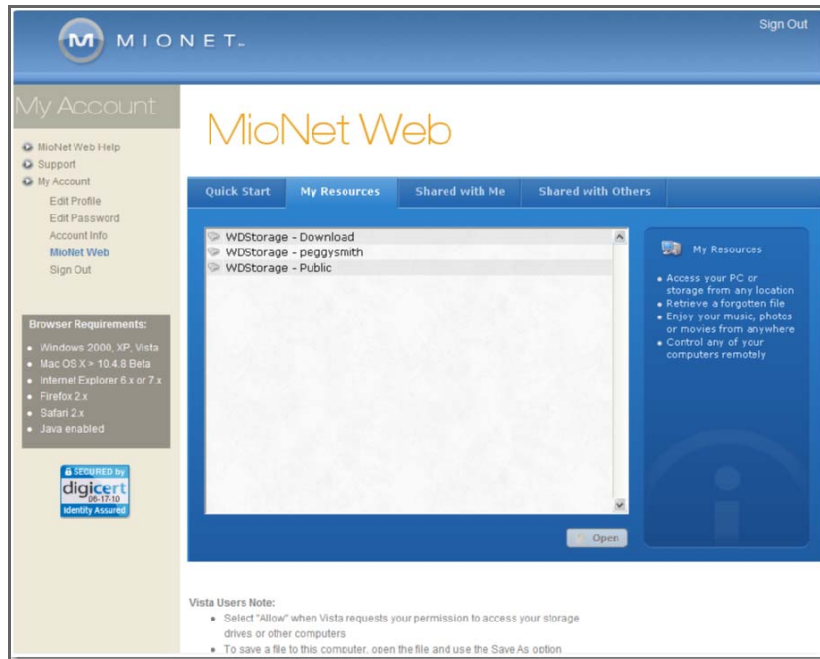

Using MioNet Web (after registration)

1. From any browser, go to www.mionet.com/web and enter your username and password. The Quick Start tab appears, displaying icons representing activities you can perform.



Note: In this User Manual, we discuss the most basic options. For more advanced options, see the MioNet Help or MioNet User Guide (available when you click the Online Help icon).

Accessing WD ShareSpace Folders and Files Remotely



.....
 Note: Local access to WD Storage using MioNet Web is not available. Use Window's Explorer or Apple Finder.

1. Click the **My Resources** tab to display your WD ShareSpace folders.
 Your WD ShareSpace folders display in the **My Resources** tab of MioNet.

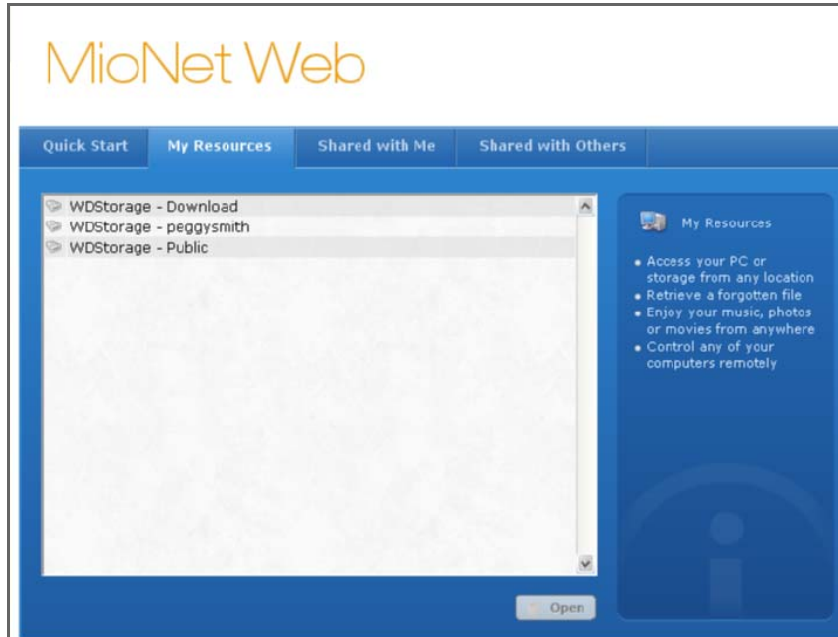

2. Select a folder to see a list of all the sub-folders and files. You can now use your browser to access your entire collection of music, photos, movies, and documents.
3. Double-click any file to open it locally. You may be able to drag and drop files from your WD ShareSpace to the remote computer and vice versa.

Sharing Files with Others

Sharing Photos

You can easily share a folder of photos on your WD ShareSpace with others. It is a simple three-step process. First you choose the folder you wish to share, then who you want to share with, and finally what permissions they have to access the folder.

1. Click the Share Photos icon.

2. Choose any folder or the plus sign to choose a sub folder to share with someone else and click the **Next** button.

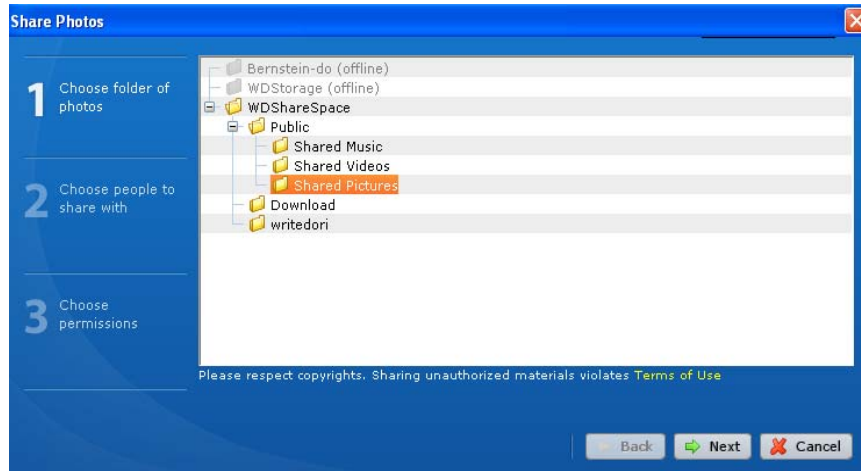

The screen for choosing people to share with appears.

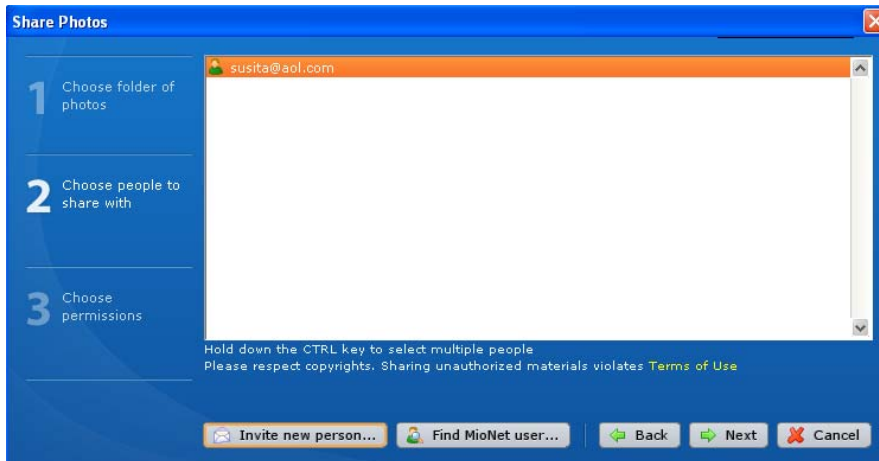

3. To share photos with MioNet users you have shared with in the past:
 - (a) Select the user(s) and click the **Next** button.
 - (b) Continue with step 6.
4. To add a new user to share with:
 - (a) Click the **Invite new person** button.
 - (b) Enter the user's e-mail address and click the **Continue** button.



- (c) Continue with step 6.
5. To find another MioNet user you have never shared with before:

- (a) Click the **Find MioNet user** button.
- (b) Enter the user name or e-mail address of the user and click the **Find** button.

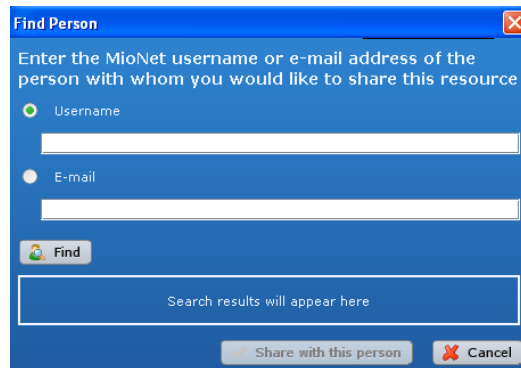

- (c) When MioNet finds the user, click the **Share with this person** button.

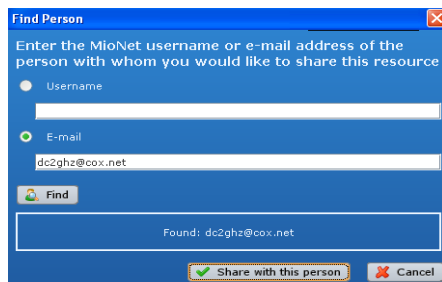

- (d) Continue with step 6.

6. From the list of users, select the user(s) you want to share with and click the **Next** button.



.....
Note: You can press the **Ctrl** key in Windows or the **Command** key on the Mac to select multiple users.

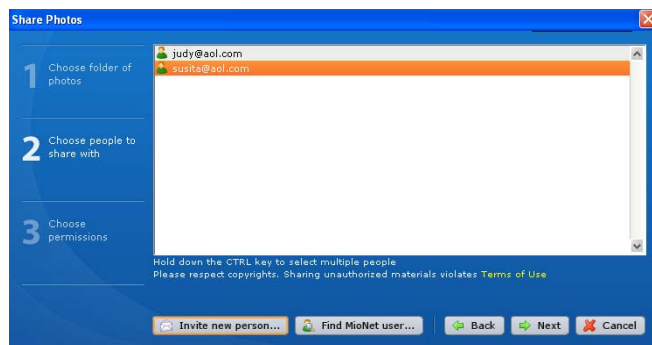

- (e) Select the permission level and click the **Next** button. If you want users to only view the photos, select **read** permission. If you want to enable users to add photos (or modify or delete photos) to your folder, give them the **read/write** permission.

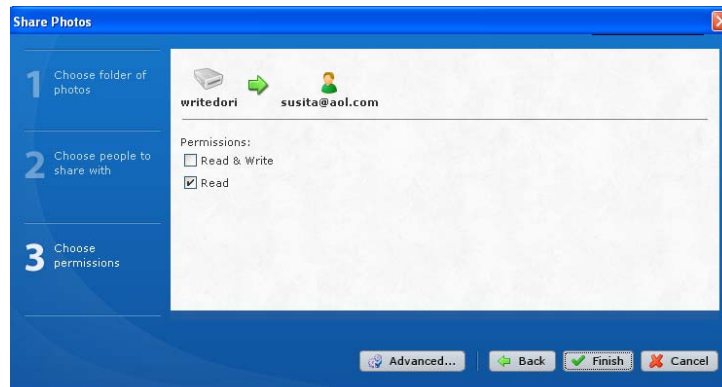

The person you invite receives an e-mail with a link to click. MioNet automatically opens up in the user's web browser and provides instant secure access to the folder of photos on your computer.

Transferring Files to Others

MioNet enables you to transfer files to others to whom you have granted access, and to have them transfer files to you.



.....
Note: MioNet transfers are not as fast as LAN transfers.

1. Click the Transfer Files to Others icon to open a dialog window showing your WD ShareSpace folders.
2. Click the **+** to navigate through your directory to highlight the folder you wish to transfer files from and click the **Next** button.

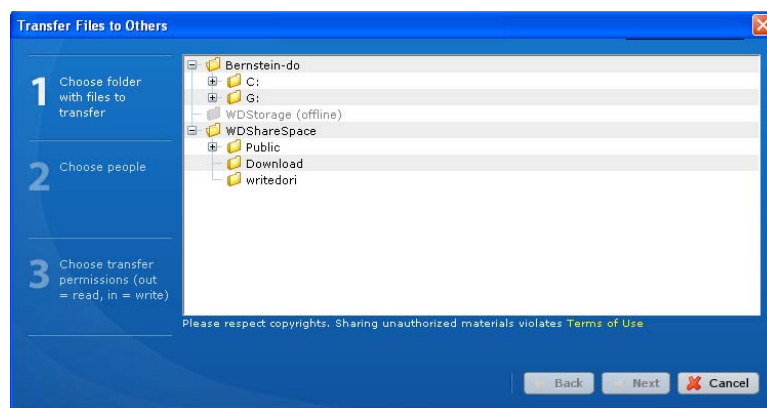

The following screen appears.

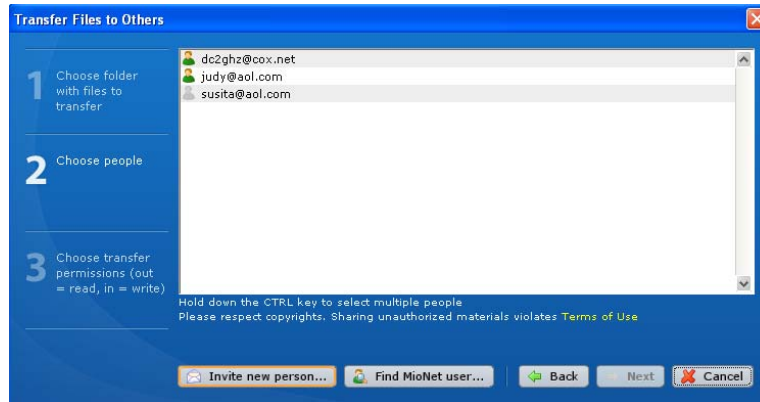

3. To transfer files back and forth with MioNet users you have shared with in the past:
 - (a) Select the user(s) and click the **Next** button.
 - (b) Continue with step 6.
4. To add a new user to transfer files to and from:
 - (a) Click the **Invite new person** button.
 - (b) Enter the user's e-mail address and click the **Continue** button.



- (c) Continue with step 6.
5. To find a MioNet user you have never shared with before:
 - (a) Click the **Find MioNet user** button.
 - (b) Enter the user name or e-mail address of the user and click the **Find** button.

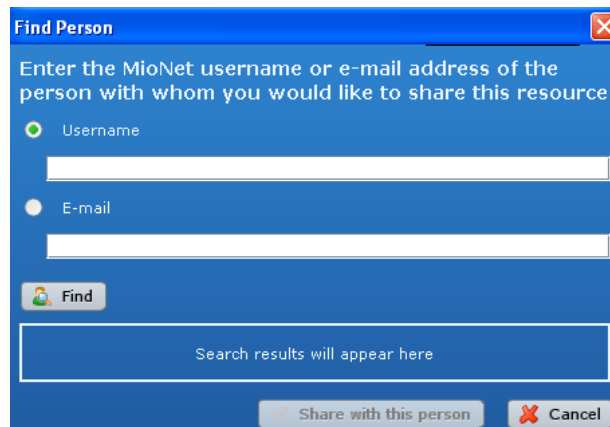

- (c) When MioNet finds the user, click the **Share with this person** button.

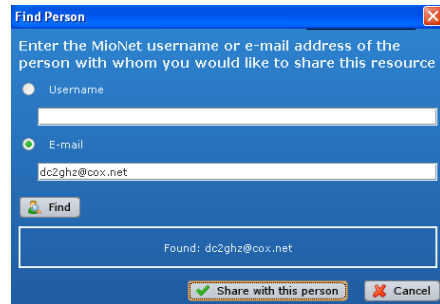

- (d) Continue with step 6.

6. From the list of users, select the user(s) you want to transfer files to and from. Click the **Next** button.



 Note: You can press the **Ctrl** key in Windows or the **Command** key on the Mac to select multiple users.

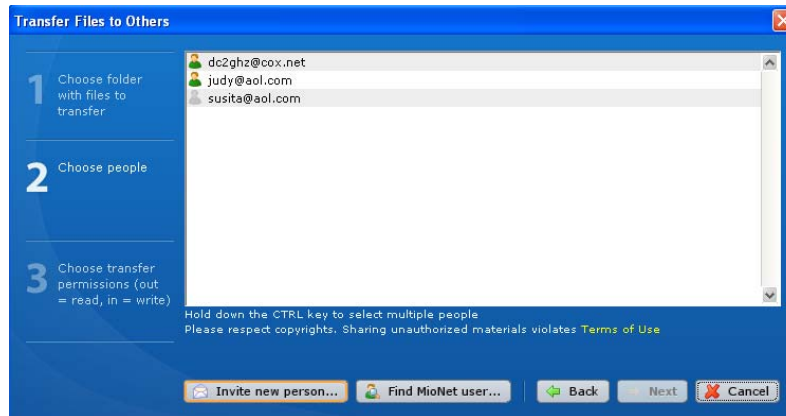

7. Select the permission level and click the **Next** button. If you want users to only transfer the files to themselves, give them the **read** permission. If you want to enable them to transfer files to you (or modify or delete your files), give them the **read/write** permission.

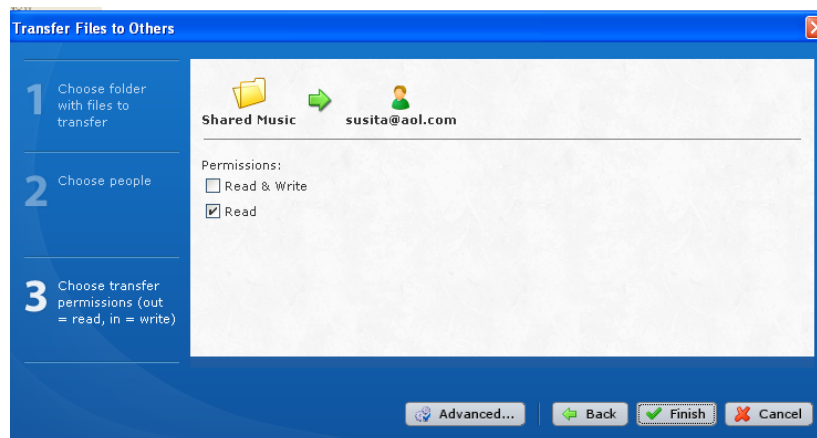

MioNet automatically opens up in the user's web browser and provides instant secure access to the folders or files on your computer. They can then double-click the file to open it and save it to their local PC.

5



How to Play/Stream Video, Music & Photos

Media Server Overview

WD ShareSpace is designed to serve as your home's central media hub. It enables you to stream photos, music, and videos to your home entertainment center and/or other PCs on your home network.

The Twonky Media server application searches for the media in the three shared folders (Videos, Photos, and Music) stored on the WD ShareSpace connected to your home network. The server is pre-set, so you can just transfer your multimedia content to the respective shared folders on your WD ShareSpace (described on the next page), and you are ready to stream and view content on your home entertainment center, game consoles (for example, Xbox 360, Playstation 3, or DLNA 1.5 Digital Media Adapters). Visit www.twonkymedia.com for further information on Twonky Media.

Media Types Supported

Shared Music	Shared Videos	Shared Pictures
		
Audio files	Video files	Image Files
MP3	MPEG1	JPEG
WMA	MPEG2	PNG
WAV	MPEG4	TIF
LPCM	AVI / DivX	BMP
OGG vorbis	WMV	
FLAC	VOB	
M4A	3GP	
M4B	VDR	
MP4	ASF	
3GP	MPE,	
AAC	DVR-MS	
MP2	Xvid	
AC3	M1V	
MPA	M4V	
MP1		
AIF		



Note: Some devices may not support playback of all these files. Please refer to your device's user manual to see which formats are supported.

Media Storage

You can access and store media content on WD ShareSpace via network shares. Shares are folders that can be used to organize and store files on your WD ShareSpace. Shares can be shared with everyone (public) or with selected users on your network (private).

The device comes pre-configured with the Public network share, which contains the following folders for media storage:

- Shared Music - folder for storing music files you want to share with other users
- Shared Pictures - folder for storing image files you want to share with other users
- Shared Videos - for storing video files you want to share with other users



Important: Do not change or delete these default share folders. Disruption of file sharing could result. These are the default folders for the Media Server (Twonky Media) and iTunes Service. For more information on how to use Twonky media, see “Media Server” on page 125. For more information on how to use the iTunes service, see “iTunes” on page 126.

How and Where to Add Media Content to the Shared Folders

1. Open the Internet Explorer.

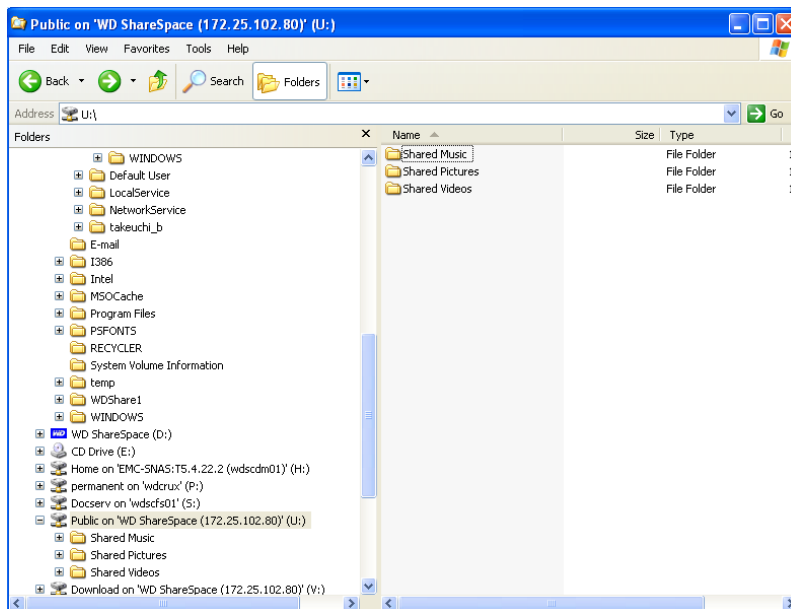

2. Copy your music files to the Shared Music folder, which is under the Public folder on WD ShareSpace.
3. Follow the same process to place your videos and pictures into their respective Shared Pictures and Shared Video folders.



Important: Make sure to sort and add your media content to the corresponding shared folders. (e.g., music files must go into the Shared Music folders). If you do not do this, your content will not display correctly through your digital media adapter.

Media Devices

Now that you have copied your files to their corresponding folders, you can use a variety of media devices to stream media. The following types are discussed in this section:

- Windows Media Player 11 (Windows Vista) on page 53.
- Xbox 360 on page 55.
- Xbox 360 - New User Interface on page 56.
- Playstation 3 on page 56.
- Digital Picture Frames on page 56.
- Network Music Player on page 57.
- Digital Media Adapters on page 57.
- DLNA Devices on page page 57.

Windows Media Player 11 (Windows Vista)

How to Stream Media Using Windows Media Player 11 Library

1. Click **Control Panel > Network and Sharing Center**.
2. Click **Customize**.

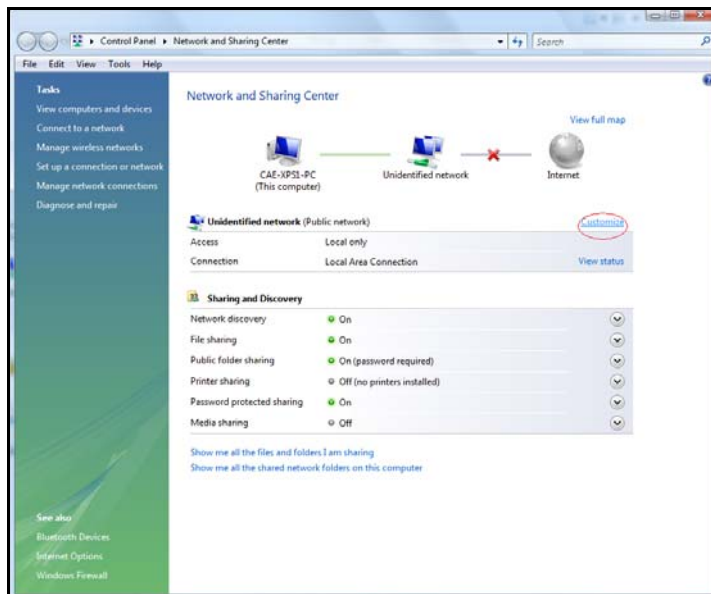

3. Click **Private**, and then click **Next**.

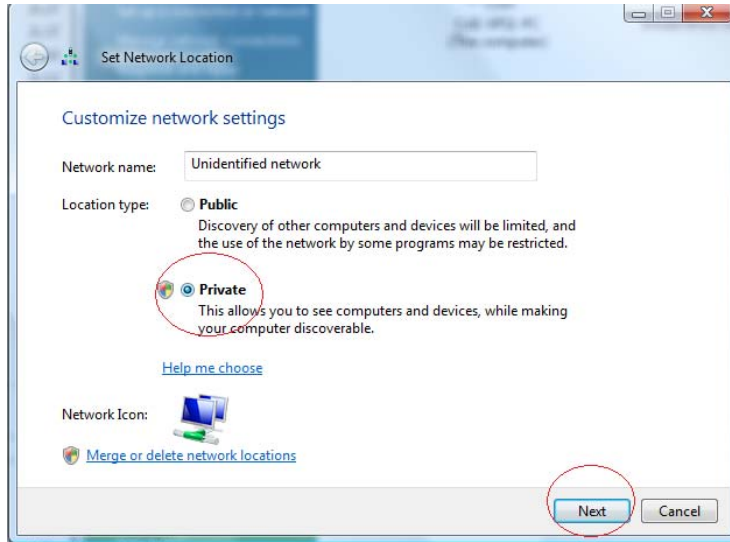

4. Launch Windows Media Player (**Start > All Programs > Windows Media Player**).

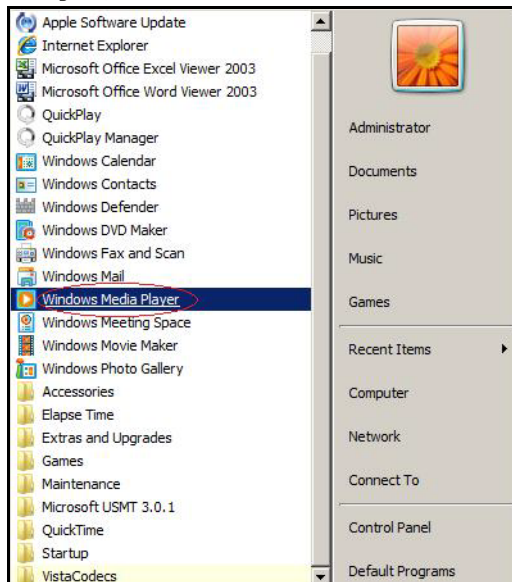

5. Click **Library > Media Sharing**.

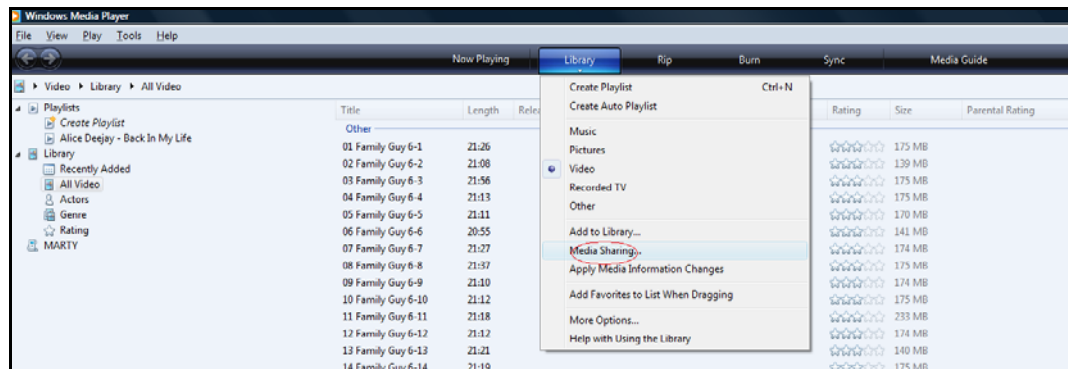

6. Click **Find media that others are sharing**, and then click **OK**.

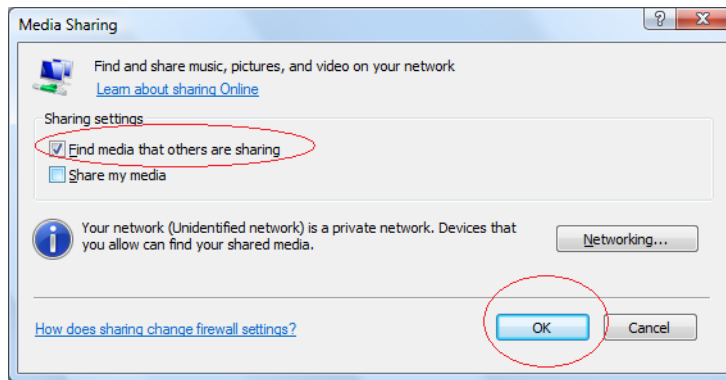

7. Select a media type (Music, Pictures, or Video) and click **PVConnect on WDSHareSpace**.

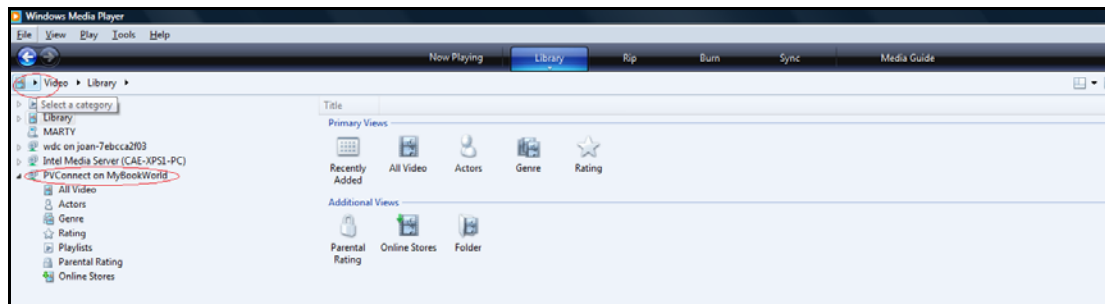

8. Double-click the media file you want to play.

Xbox 360

1. Ensure that your Xbox 360 and WD ShareSpace are powered on and connected to your local area network. The main Xbox screen displays five screens you can scroll through (Marketplace, Xbox Live, Media and Network).



.....
Note: If you have any devices with Window Media Center, the Xbox 360 will display a user interface screen asking you to connect to that device. Click **B** to exit.

2. Scroll to the Media Screen and select the Music option (you have three options - Music, Pictures, and Videos). The Source screen appears.
3. Click **WDSHareSpace** or the WD ShareSpace device name if you have already changed the names previously. (See "Device Name" on page 79.) The Music player screen appears with the device name at the top of the screen.
4. Click **Songs** to view the songs stored in your Shared Music folder.
5. Use the music player navigation buttons on the screen to play your music files.
6. To view your pictures or play video content that are on your WD ShareSpace, go back to step 3 and repeat the steps, selecting the appropriate media (Picture or Video).

Xbox 360 - New User Interface

1. Ensure that your Xbox 360 and WDSHareSpace are powered on and connected to your local area network.
2. From the main Xbox user interface, scroll to the My Xbox screen
3. Use the D-Pad and scroll to the right until you see Video, Music and Picture Library options.
4. Select any one of these three options by pressing the **A** button on your controller. The Select Source screen appears.
5. Select the WDSHareSpace option based on the device name you created previously and press the **A** button. You will see the media content stored on your WDSHareSpace unit.
6. Using the controller, scroll through to view and play your media content.

Playstation 3

1. Ensure that your Playstation 3 and WD ShareSpace are powered on and connected to your local area network. You will see the main user interface with a series of options displayed horizontally across your TV screen.
2. Using the directional buttons (left and right) on the PS3 controller, navigate to Music, Photo or Video depending on which type of media you want to play, and press the **X** button.
3. Using the directional buttons (up and down), scroll and select WDSHareSpace (or the new device name that you created previously) by pressing the **X** button. You will now see a list of folders (Music, Photo and Video) to the right of the WDSHareSpace icon.
4. Make sure that you select the folder that corresponds to option you selected back in Step 2. For example, if you select Photo from the main user interface screen, open the corresponding Photo folder to the right of the WDSHareSpace icon, otherwise your content will not display properly.

Digital Picture Frames

The following are general steps for setting up digital photo frames:

1. Ensure that your WD ShareSpace is connected to your home's local network and is powered on.
2. Follow the user instructions provided with your wireless digital photo frame to proceed through any initial setup or installation of drivers.
3. Using the navigation feature on your wireless digital photo frame, scan and detect the WD ShareSpace on your network.
4. Depending on the brand of photo frame you have, you may need to access Settings/Network Setup page in the user interface to establish connection so that your photo frame can link to your WD ShareSpace. Please refer to your DMA's user guide for specific instructions.

5. Once you have a connection between your wireless photo frame and the WD ShareSpace, access the Media screen on your photo frame that will provide you the option to view your pictures.



.....
Please refer to your wireless photo frame user guide for supported picture file formats and instructions on accessing and viewing your pictures.

Network Music Player

The following are general steps for using a network music player to access WD ShareSpace:

1. Connect WD ShareSpace to your local area network and power on the device.
2. Connect and configure your network music player on your home's wired or wireless network switch or router.
3. Turn on your network music player.
4. If connected properly, you will find the device name of your WD ShareSpace.
5. Navigate through the network music player's user interface to locate and play music stored on your WD ShareSpace.



.....
Note: Please refer to your network music player user guide for specific instructions on connecting to a network attached storage system and how to access and play your media content.

Digital Media Adapters

The following are general steps for using a Digital Media Adapter (DMA) to access WD ShareSpace:

1. Connect WD ShareSpace to your local area network and power on the device.
2. Make sure that your DMA device is connected to your TV and powered on.
3. The main screen of your DMA device appears.
4. Depending on the DMA device, you may need to access the Settings/Network Setup screen in the user interface to establish a connection between your DMA and WD ShareSpace. Please refer to your DMA's user guide for specific instructions.
5. Once you have a connection established between your DMA and WD ShareSpace, access the Media screen on your DMA to view your pictures or stream music and video content from the WD ShareSpace.



.....
Note: Please refer to your DMA's user guide for specific instructions on connecting to the WD ShareSpace and how to access and play your media content.

DLNA® Devices

See specific DLNA media device user manuals for instructions on connecting a DLNA device to your local area network so you can access content on WD ShareSpace. Go to www.dlna.org for a list of DLNA-certified devices and for further information.

6

Using iTunes with WD ShareSpace

iTunes Media Server Overview

With the iTunes Media Server Service, you or anyone connected to the WD ShareSpace can play music files stored on the system using iTunes. This service creates a virtual music library on the device and treats it as an iTunes repository, making it possible for music files to stream from the WD ShareSpace to Windows or Mac computers running iTunes.

Media Types Supported

The iTunes Server Service supports the following file types:

- *.mp3
- *.wav
- *.aac



.....

Note: The iTunes server service requires the presence of the '/Public/Shared Music' share folder. Do not rename or delete Shared Music if you want to use the iTunes server. You must recreate or rename the '/Public/Shared Music' folder if it has been deleted or given another name.

Storing Content

See “Step 2: Access WD ShareSpace on the Network” on page 10 for instructions on moving your media files to WD ShareSpace’s '/Public/Shared Music' default folder.

Streaming Audio in iTunes

The iTunes Service is enabled by default in the WD ShareSpace’s Network Storage Manager utility. See “To enable or disable the iTunes Server Service:” on page 126 for more information.

1. Launch iTunes on your computer.
2. Click **WDShareSpace** under the Shared section of the left pane. If you have copied music to the /Public/Shared Music folder and it is in a format supported by iTunes, it should be listed in the right pane.

3. Double-click an audio file to play.

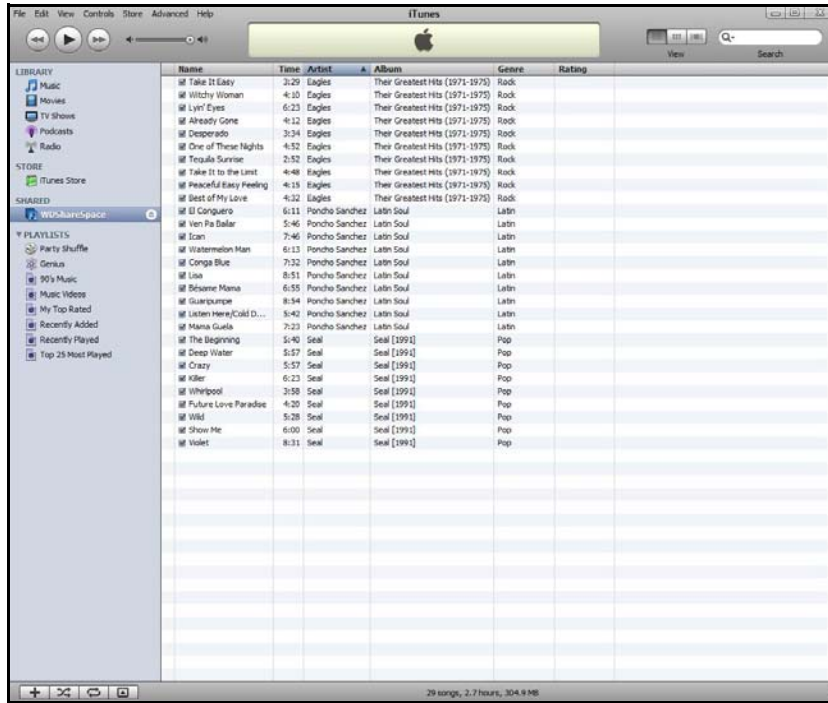

The audio file is streamed in iTunes, and audio files from the WD ShareSpace are displayed under the **Shared** list.

7

External USB Drive Sharing & Backup

Sharing Data on a USB Drive

You can share data on your USB drive with other users connected to the WD ShareSpace. When a USB storage device with the FAT, FAT32, or NTFS file system is connected to the network storage device, the USB device will be displayed as a USB share.

To share data on a USB drive:

1. Connect a USB drive to any of the three USB ports. The front port is USB1 and the two rear ports are USB2 and USB3 from top to bottom.



.....

Note: The WD ShareSpace supports external USB storage; USB optical drives (CD/DVD combo or DVD dual/multi drive) are not supported. The USB ports currently support attached drives with Fat32, NTFS, EXT3 file systems. HFS+J and proprietary devices (e.g., cameras) are not currently supported.

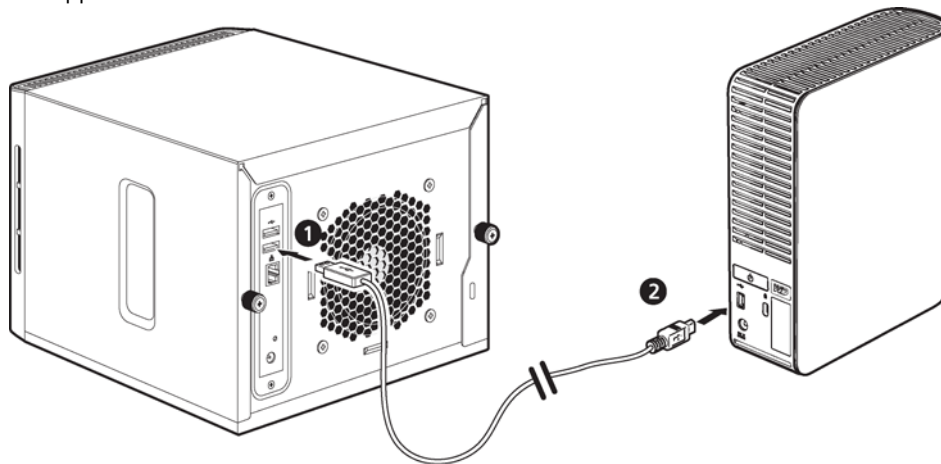

2. Open the WDShareSpace folder to access data on the USB drive. Double-click on the USB share. The USB share name will appear as usb1-1 share, usb2-1 share, or usb3-1 share, depending on the actual USB port that the USB drive is connected to.

USB Auto Backup Feature

The WD ShareSpace's auto backup feature allows you to back up data in either direction—from a USB drive to the WD ShareSpace or from the WD ShareSpace to a USB drive. You have to select your destination and source as described in “USB to WD ShareSpace Backup” on page 120.





.....

Important: When backing up data, always connect the USB drive directly to USB port 1 located on the front panel. **Do not use a USB hub.** Ensure that the destination drive has enough free space to store the amount of data being transferred.

To back up FROM a USB drive:

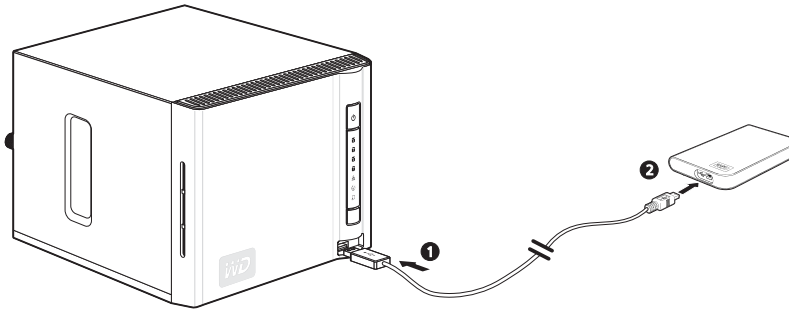
1. Connect a USB drive to the USB port (Port 1) located on the front panel, and wait for a few seconds for the USB backup LED  on the front of the unit to light steadily (this could take up to 30 seconds).



2. Press and hold the USB backup button only until the USB backup LED  turns off (about 2 seconds). While the backup is in progress, the USB LED will flash once per second. When the backup is complete, the LED will remain on steadily.

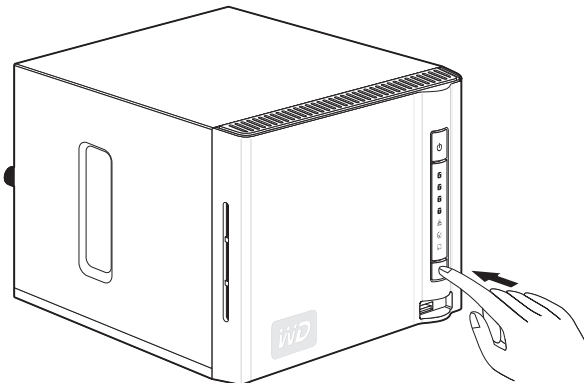

.....
Note: The first backup will copy the entire first partition of the USB drive. Subsequent backups will copy only new and updated files.

The system will back up data from the USB drive to the “Public” default share folder on the WD ShareSpace. The share folder will be automatically named after the USB drive plugged into Port 1.

Example: usb_Western_Digital_External_HDD-200806201424

To back up TO a USB drive:

1. Prior to performing the backup operation, make sure to choose a source and destination in the WD ShareSpace’s Network Storage Manager utility. See “To set a source share name for WD ShareSpace to USB drive backup:” on page 121 for more information.

2. Connect a USB drive to the USB port (Port 1) located on the front panel of the WD ShareSpace, and wait for the USB backup LED  to turn off (about 2 seconds).

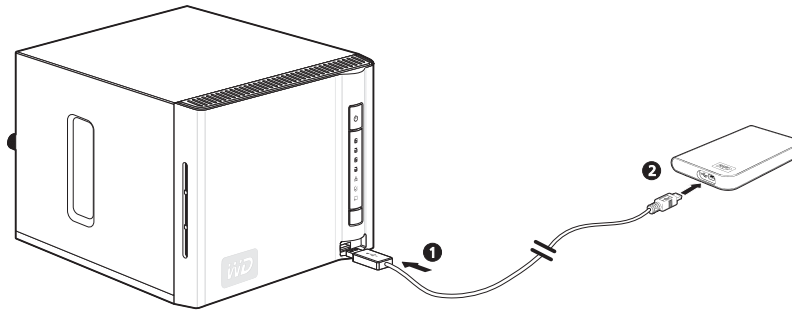

3. Press and hold the USB backup button until the USB backup LED on the front of the unit begins to flash (about 3 seconds). The USB LED will flash twice per second while the backup is in progress and will light steadily when the backup is complete.

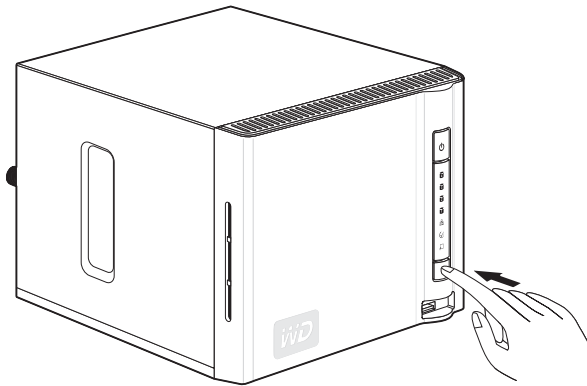

The system will back up data from the pre-selected source share folder on the WD ShareSpace to the USB drive first partition.



.....
Note: If the USB drive does not have enough free space to back up the selected portion of the WD ShareSpace, an error will display when the USB drive is full. The error will appear as a flashing red LED on the front of the ShareSpace, as well as a text message at the top of the WD ShareSpace's Network Storage Manager web page.

8

Using WD Discovery (Windows Only)

WD Discovery Overview

WD Discovery is a proprietary utility that aids in connecting to the WD network drives. The easy-to-use software enables you to quickly locate and set up the WD ShareSpace from any Windows computer on your network. With WD Discovery, you can easily map network drives, browse shared folders, and create a desktop shortcut for quick access to your WD ShareSpace.

WD Discovery provides the following options:



Configure your WD ShareSpace device using the WD ShareSpace's Network Storage Manager interface. See "Configuring WD ShareSpace" on page 69.



Automatically map a network drive so you can easily share and store data on your WD ShareSpace. See "Mapping a Network Drive" on page 63.



Easily browse network shares without having to manually enter network paths. See "Browse Network Shares" on page 66.



Create a desktop shortcut that points to a networked WD ShareSpace. See "Desktop Shortcut Creation" on page 67.

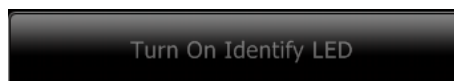

Determine which WD ShareSpace in the network is currently being accessed by WD Discovery. See "Turning Identify LED On or Off" on page 67.

Mapping a Network Drive

To access and store data on WD ShareSpace after setting up the device, you must first map a network drive to one or more of the default shares. Install the WD Discovery application on each Windows XP or Vista computer in your network to easily map a network drive, browse network shares, or create a desktop shortcut.

Windows 2000/XP/Vista/Server 2003



.....
Note: Follow the steps below only if you have already installed WD discovery as instructed in "Windows 2000/XP/Vista/Server 2003" on page 10.

1. Turn on your computer and wait for the operating system to load.
2. If WD Discovery is not running:

For Windows 2000/XP, click **Start > All Programs > WD Discovery Software > WD Discovery** or double-click the WD Discovery icon on your desktop.

For Vista, click **Start > Programs > WD Discovery Software > WD Discovery** or double-click the WD Discovery icon on your desktop.

WD network drives are listed in the Network Drives Found list.

3. Click the device you want to map in the Network Drives Found list and click **Map Network Drive** in the Things to Do list.



4. In the authentication screen, enter your **User Name** and **Password**. The default for both is “admin.”



A message appears asking whether you want to map the drive automatically. Continue with “**Automatic Drive Mapping**” or “**Manual Drive Mapping**” on page 65.

Automatic Drive Mapping

1. After completing step 4 of “Windows 2000/XP/Vista/**Server 2003**” on page 63, click **Yes**.



All share folders available on the device will be mapped as network drives automatically. Available drive letters are assigned backwards from Z.

When mapping completes, the share folders appear as network drives in the WD Discovery screen.



2. Click **Back** to return to the main page.

Manual Drive Mapping

1. After completing step 4 of “Windows 2000/XP/Vista/**Server 2003**” on page 63, click **No**. All share folders on the device are listed on-screen. Select a folder name, then select a drive letter.
2. Click **Yes** to complete drive letter assignment.

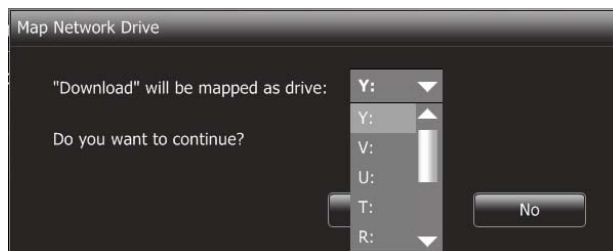

3. Click **My Computer** on Windows 2000 or XP and **Computer** on Vista. The network drives display. You can now drag and drop files into the network drive folders using My Computer or Windows Explorer.

Browse Network Shares

To access data on a share using **WD Discovery**:

Use **WD Discovery** to easily browse network shares without having to manually enter drive paths.

1. Ensure that the device is powered on and connected to the network.
2. For Windows 2000/XP, click **Start > All Programs > WD Discovery Software > WD Discovery** or double-click the **WD Discovery** icon on your desktop.

For Vista, click **Start > Programs > WD Discovery Software > WD Discovery** or double-click the **WD Discovery** icon on your desktop.

3. Click **WDSHareSpace** in the Network Drives Found list and click **Browse Network Shares** in the Things To Do list.



4. After successful login, the share folders on the device are listed. Click a share to view and access share files in Windows Explorer.



Desktop Shortcut Creation

WD Discovery can create a desktop shortcut that points to a networked WD ShareSpace. Follow these steps to create a desktop shortcut:

1. Ensure that the device is powered on and connected to the network.
2. For Windows 2000/XP, click **Start > All Programs > WD Discovery Software > WD Discovery**, or double-click the WD Discovery icon on your desktop.

For Vista, click **Start > Programs > WD Discovery Software > WD Discovery**, or double-click the WD Discovery icon on your desktop.

3. Click **WDSHareSpace** in the Network Drives Found list, and then click **Create Desktop Shortcut** in the Things To Do list.



4. A dialog appears informing you that the desktop shortcut has been created successfully. Click **OK**.

Turning Identify LED On or Off

Users with multiple WD ShareSpace devices can use the blue Identify LED feature to find out which WD ShareSpace in the network is currently being accessed by WD Discovery. WD Discovery allows you to turn on or turn off Identify LED on a networked WD ShareSpace.



.....
Note: This feature is only available on a WD ShareSpace network drive.

To turn on the Identify LED on a networked WD ShareSpace:

1. Ensure that the device is powered on and connected to the network.
2. For Windows 2000/XP, click **Start > All Programs > WD Discovery Software > WD Discovery**, or double-click the WD Discovery icon on your desktop.

For Vista, click **Start > Programs > WD Discovery Software > WD Discovery**, or double-click the WD Discovery icon on your desktop.

3. Click **WDSpace** in the Network Drives Found list and click **Turn On Identify LED** in the Things To Do list.



4. The Identify LED on the target device is turned on. The LED icon appears to the left of the device name in WD Discovery.



To turn off the Identify LED on a remote networked WD ShareSpace device:

1. Ensure that the device is powered on and connected to the network.
2. Click **Start > Programs > WD Discovery**.
3. Click **WDSpace** in the Network Drives Found list and click **Turn Off Identify LED** in the Things To Do list.

The Identify LED on the target device is turned off. The LED icon to the left of the device name in WD Discovery is also turned off.

9

Network Storage Manager: Basics

WD ShareSpace's Network Storage Manager is a powerful and convenient user interface for managing and configuring your WD ShareSpace.



.....
Note: Accessing and setting up the WD ShareSpace's Network Storage Manager is not required to begin using your WD ShareSpace right away.

This chapter explains how to configure the WD ShareSpace, access WD ShareSpace's Network Storage Manager, and enter basic settings. For instructions on configuring advanced settings, see "Network Storage Manager: Advanced" on page 87.

Configuring WD ShareSpace

Follow the instructions below to configure your WD ShareSpace for Windows or Mac.

Windows 2000/XP/Vista



.....
Note: Follow steps 1-6 below only if you have **not** already installed WD Discovery Tool as instructed on page 10. Otherwise, launch WD Discovery Tool using the desktop icon and continue with step 7.

1. Turn on your computer and wait for the operating system to load.
2. Insert the WD ShareSpace software CD into the CD-ROM drive.



.....
Note: If AutoPlay is disabled on your computer, you must install the utilities manually. Click **Start** and then **Computer** (Windows Vista) or **My Computer** (Windows 2000/XP). Right-click the CD/DVD drive, click **Open**, and double-click **Setup.exe**.

3. *Windows Vista:* Click **Run setup.exe**, and then click **Allow**.
4. Click **Accept** in the Terms of Agreement screen.
5. If you have connected the device properly as shown in the Connect screen, click **Next**.
6. The Application Installer screen opens, displaying a list of options. Click **WD Discovery Tool**.

- The WD Discovery screen appears. Click **WDSHareSpace** in the Network Drives Found list and click **Configure**.



- The login page appears. Continue device setup by following the instructions for “Setting Up the Device” on page 71.

Mac OS X

- Turn on your computer and wait for the operating system to load.
- Open the Safari web browser.
- Click the Bookmarks link  in the upper left corner of the screen.
- Click **Bonjour**, and then double-click **WDSHareSpace**.

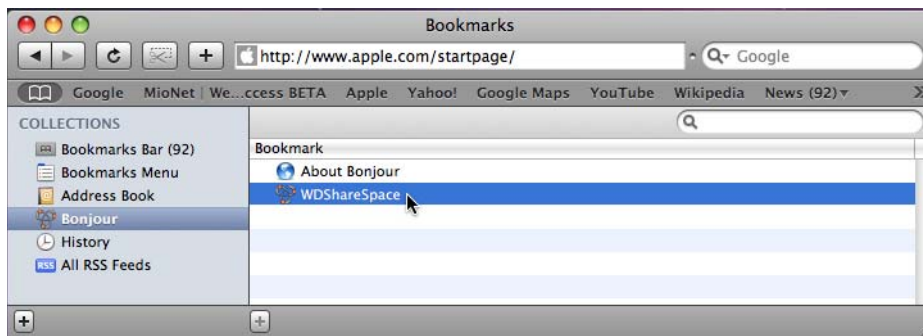

- The login page appears.



.....
Note: The Macintosh Leopard may not be able to get past the login page. Please go to support.wdc.com and search the knowledge base for answer ID 3280, which has instructions on correcting the problem.

- Continue device setup by following the instructions for “Setting Up the Device” on page 71.

Setting Up the Device

Follow the steps below to continue setting up the device for all operating systems.



Note: You will only have to perform the setup the first time you log in to WD ShareSpace's Network Storage Manager.

1. Enter "admin" in both the **Administrator Name** and **Password** fields.
2. Select a language from the **Language** list and click **Login**.

WD | Help

Login

Administrator Name: admin

Password:

Tool: Network Storage Manager

Language: English

Login

Copyright © 2008 Western Digital Technologies, Inc. All rights reserved.

3. Click **Next**.

WD | Help

Initial Setup

Welcome to the WD ShareSpace setup wizard!
The following screens take you through initial setup of your WD ShareSpace.
Click 'Next' when ready to begin.

Back Next

Copyright © 2008 Western Digital Technologies, Inc. All rights reserved.

4. Read the license agreement, and then click **I Agree**.

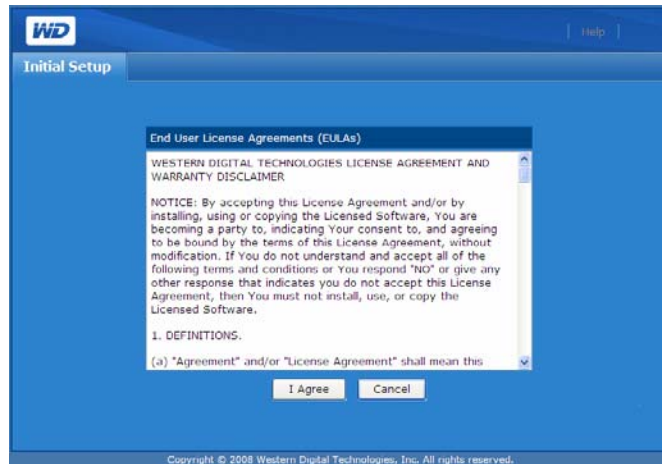

5. In the Initial Setup screen, do the following:

- (a) Enter a name in the **Device Name** field (up to 15 characters, including alphanumeric and dash '-').



.....

Note: The device name is used to identify the storage device connected to the network and appears in My Network Places. To connect more than one storage device to the same network, you must specify a unique device name for each storage device.



.....

Caution: Renaming WD ShareSpace forces all the network computers to remap their shared network resources. Change the device name only when necessary.

- (b) Enter a brief description of the device in the **Device Description** field. The maximum length of the description is 42 alphanumeric characters.
- (c) Select a time zone from the **Time Zone** list.
- (d) If necessary, adjust the date and time manually using the **Date & Time** lists.

Click **Next**.

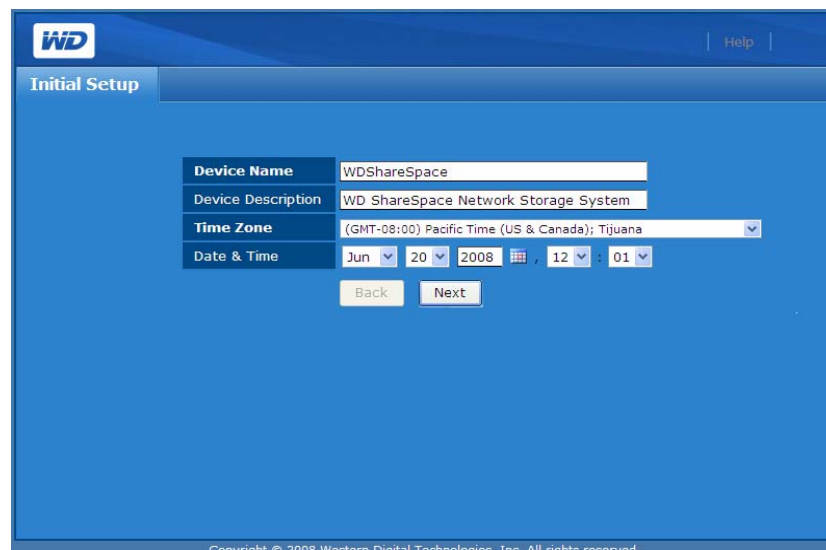

6. Enter a new admin password in the **New Admin Password** field. The maximum length of the password is 16, including alphabetic, numeric, underscore, space, and most special characters except double-quote ("). The first and last characters cannot be a space. The password is case sensitive.
7. Retype the new password in the **Confirm Password** field. Click **Next**.

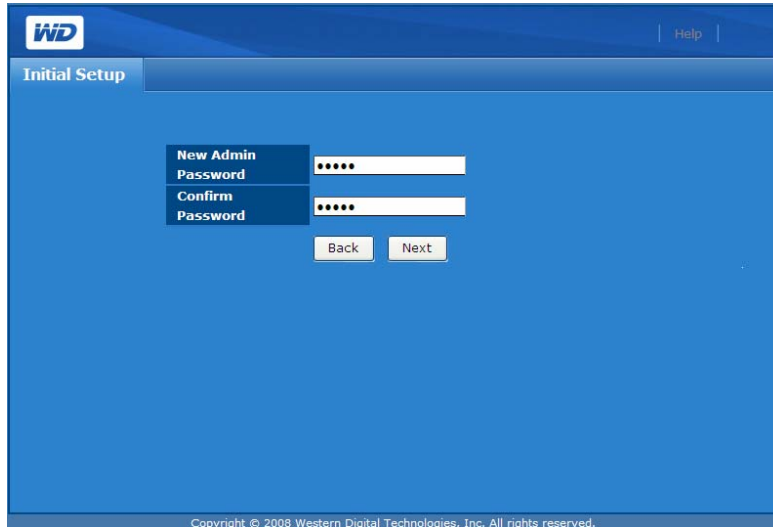

The screenshot shows the 'Initial Setup' screen for a WD device. At the top left is the WD logo, and at the top right is a 'Help' link. The main heading is 'Initial Setup'. Below this, there are two input fields: 'New Admin Password' and 'Confirm Password', both containing six dots. Below the fields are 'Back' and 'Next' buttons. At the bottom of the screen, there is a copyright notice: 'Copyright © 2008 Western Digital Technologies, Inc. All rights reserved.'



Note: If you forget your admin password, you must reset the device to its default configuration using the reset button. See "Reset Button" on page 8 for instructions.

8. Accept the default DHCP (Dynamic Host Configuration Protocol) client settings. If you are not using DHCP, click **Static** and manually assign the IP address. Click **Next**.

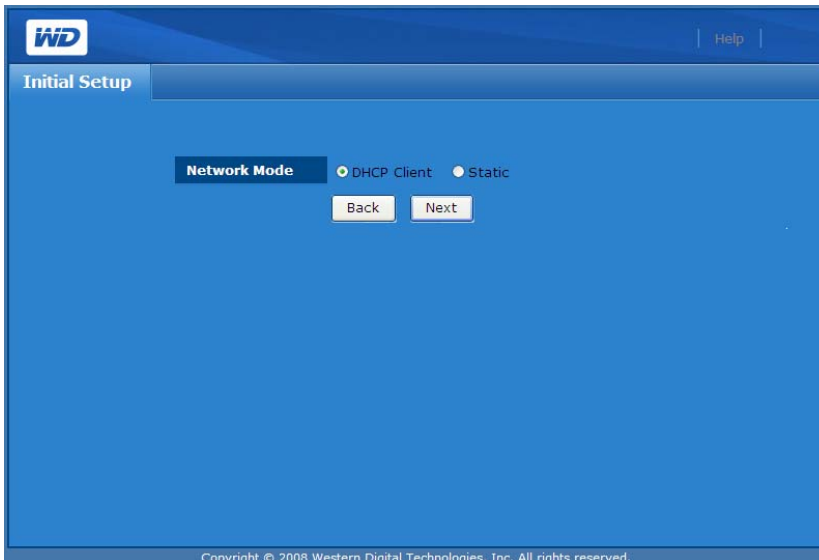

The screenshot shows the 'Initial Setup' screen for a WD device. At the top left is the WD logo, and at the top right is a 'Help' link. The main heading is 'Initial Setup'. Below this, there is a 'Network Mode' section with two radio buttons: 'DHCP Client' (which is selected) and 'Static'. Below the radio buttons are 'Back' and 'Next' buttons. At the bottom of the screen, there is a copyright notice: 'Copyright © 2008 Western Digital Technologies, Inc. All rights reserved.'

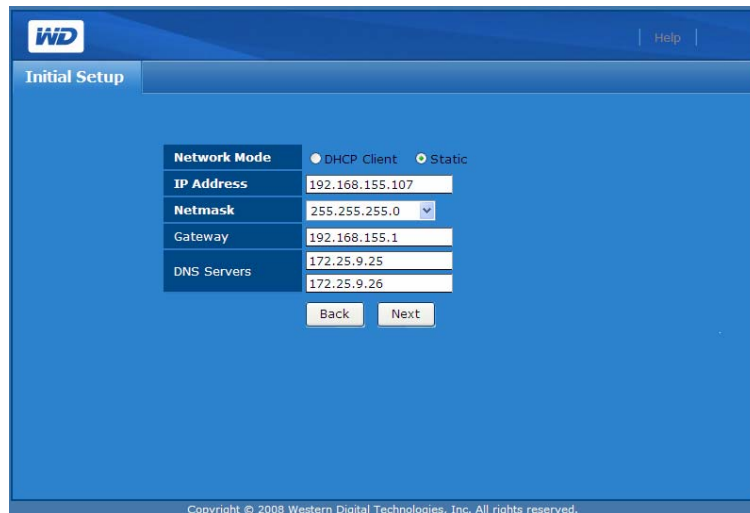

9. The Summary screen appears. Click **Finish**.

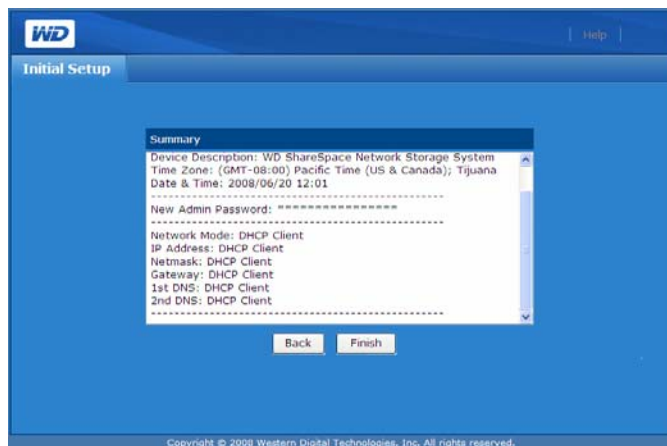

.....

Note: If you are using Windows 2000, XP, or Vista, you may notice a warning notice bar display during the final initialization of your WD ShareSpace. The bar warns that the Internet Explorer has blocked an Active X controller message. This warning disappears on its own, or you can click the **X** button to the right of the bar. This warning does not affect setting up your drive.

Accessing WD ShareSpace's Network Storage Manager

Once you have configured your WD ShareSpace and set up WD ShareSpace's Network Storage Manager, you can manage and further configure your unit by entering the web-based user interface.



.....

Important: You must configure WD ShareSpace before using WD ShareSpace's Network Storage Manager. Follow the instructions under "Configuring WD ShareSpace" on page 69.



.....

Note: Accessing and setting up the WD ShareSpace's Network Storage Manager is not required to begin using your WD ShareSpace.

Windows

1. Ensure that the device is powered on and connected to the network.
2. If WD Discovery is not running:
For Windows 2000/XP, click **Start > All Programs > WD Discovery Software > WD Discovery** or double-click the WD Discovery icon on your desktop.
For Vista, click **Start > Programs > WD Discovery Software > WD Discovery** or double-click the WD Discovery icon on your desktop.
3. Click **WDSHareSpace** in the Network Drives Found list and point to and click **Configure** in the Things To Do list.
4. The login page appears. Type in the administrator name and password (the default password is “admin” unless it has already been changed by the administrator). In the **Tool** list, click **WD ShareSpace’s Network Storage Manager**. In the **Language** list, click the language for your region. Click **Login**.

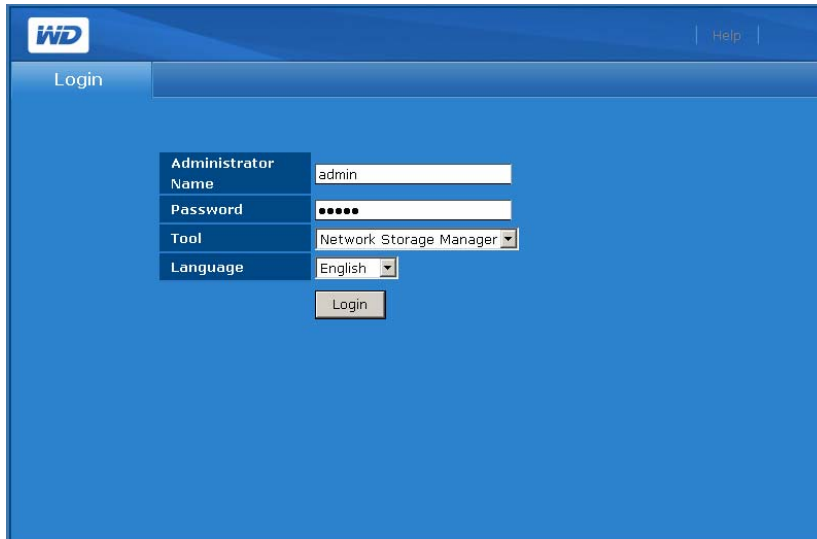

The screenshot shows a login interface for WD ShareSpace. At the top left is the WD logo, and at the top right is a 'Help' link. Below the header is a 'Login' section. It contains four labeled input fields: 'Administrator Name' (text input with 'admin'), 'Password' (password input with masked characters), 'Tool' (dropdown menu with 'Network Storage Manager'), and 'Language' (dropdown menu with 'English'). A 'Login' button is positioned below the 'Language' field.

Mac

1. Turn on your computer and wait for the operating system to load.
2. Open the Safari web browser.
3. Click the Bookmarks link  in the upper left corner of the screen.
4. Click **Bonjour**, then double-click **WDSHareSpace**.
5. The login page appears. Type in the administrator name and password. In the **Tool** list, click **WD ShareSpace’s Network Storage Manager**. In the **Language** list, click the language for your region. Click **Login**.

WD ShareSpace's Network Storage Manager Features

The web-based management utility includes the following features:

- **LAN access**—the device supports local area network access of the web-based user interface, enabling management from anywhere in the network.
- **Secured access**—the device can be accessed and configured by the web-based, password protected user interface over SSL (Secure Socket Layer).
- **E-mail notification**—in the event of warnings or errors related to temperatures, hard drive, network, or USB connection, administrators are automatically alerted by e-mail.
- **Multiple access levels**—users can be assigned different rights. The device supports two levels: full access and read only.
- **Update via web**—firmware updates can be downloaded and installed on the device from a computer on the LAN.
- **Disk management**—the web-based user interface allows administrators to monitor internal hard drives and USB drives connected to the device.
- **USB storage support**—allows reliable data backup from a USB storage device to the device.
- **RAID management**—allows RAID configuring of the hard drives.
- **Support for Windows and Mac systems**—allows users on different platforms to share files using CIFS (Common Internet File System), NFS (Network File System), or FTP (File Transfer Protocol) protocols.
- **iTunes streaming support**—allows users to stream photos, music, and videos to supported digital media adapters.
- **Twonky Media server**—provides fast, convenient navigation and searching of all your media files in the Twonky user interface.
- **Remote shutdown or reboot**—allows administrators to power off or reboot the device from any computer on the LAN.
- **System log**—an efficient instrument in analyzing and solving technical issues.
- **UPS-ready**—a UPS (uninterruptable power supply) device can be connected to one of the USB ports to provide secondary power in the event of a power failure. Go to support.wdc.com and search the knowledge base for answer ID 2559 for a list of compatible UPS devices.
- **Upgradable firmware**—enables you to keep your system up to date. For more information, see “Update (Firmware)” on page 93.

User Interface Overview

The web-based user interface is designed to logically access and manage the features of the device. Upon logging in, the web user interface defaults to Basic Mode. Basic Mode provides access to the most common device configuration options.



The Advanced Mode page includes six tabs and each tab is subdivided into several menu buttons providing advanced task management functions. The toolbar located on the upper right allows you to switch between Advanced Mode and Basic Mode any time.

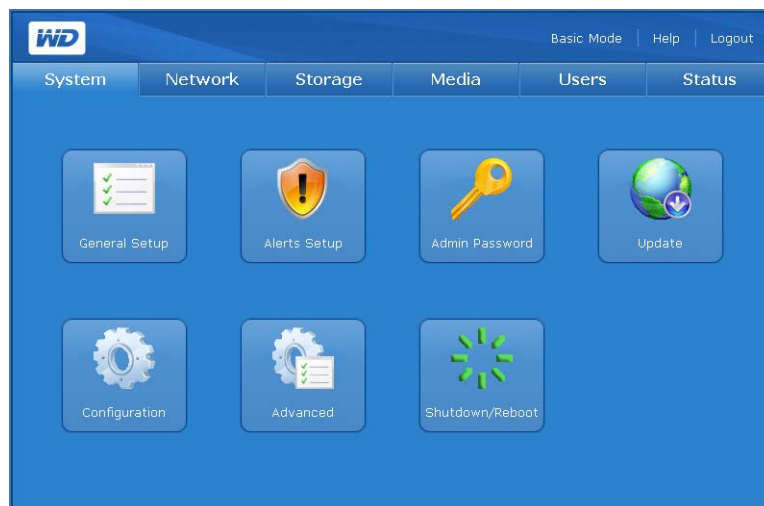

Note: See "Network Storage Manager: Advanced" on page 87 for instructions on using Advanced Mode.

Toolbar

The toolbar located on the upper right of the WD ShareSpace's Network Storage Manager user interface includes the following commands.

Function	Description
Advanced	Allows you to switch the user interface from basic to Advanced Mode.
Basic	Allows you to switch the user interface from advanced to Basic Mode.
Help	Displays online help.
Logout	Exits the utility.

Basic Mode

The Basic Mode provides access to the most common configuration options.

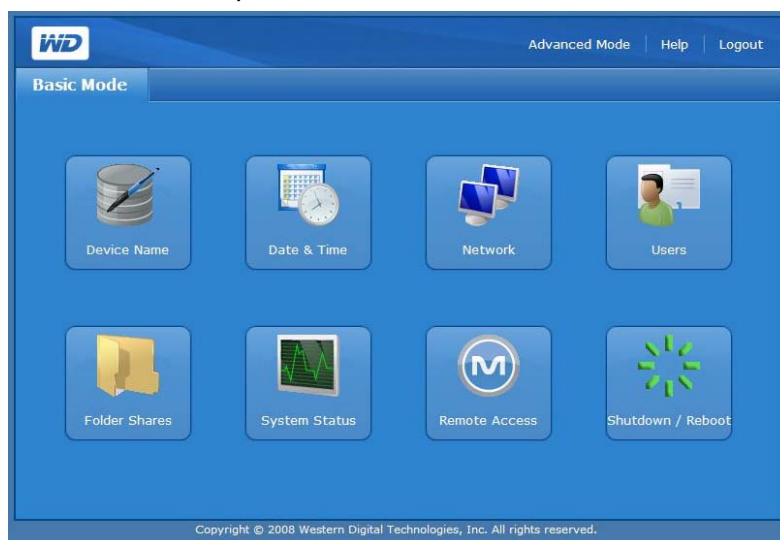

Click any of the icons to display the available configuration options. The table below describes the options.

Category	Description
Device Name	Enter a device name and description. For more details, see "Device Name" on page 79.
Date & Time	Set the system date and time manually or set the NTP server to allow date and time to be updated automatically. For more details, see "Date & Time" on page 79.
Network	Configure the network connection. For more details, see "Network" on page 80.
Users	Create and delete user accounts and change the user password. For more details, see "Users" on page 81.
Folder Shares	Access configuration details relating to how shares are made available through this storage device. This menu also displays a list of mounted volumes and their available shares. When a USB drive is connected to the device, the USB drive displays as USB share. For more details, see "Folder Shares" on page 83.
System Status	Displays general information about the storage device, such as device name, firmware version, current date/time, system uptime, IP address, volume usage, and volume RAID type. For more details, see "System Status" on page 85.

Category	Description
Remote Access	Enables or disables the MioNet software. Computers running MioNet can remotely access and share files on the storage device over the Internet. <i>Note:</i> Available only on computers running Windows. For more details, see “Remote Access” on page 85.
Shutdown/ Reboot	Performs device shutdown or reboot from any computer on the local area network (LAN). For more details, see “Shutdown/Reboot” on page 86.

Device Name

Use this option to enter or change a device name and/or a description of the device. The device name is the name by which your WD ShareSpace is identified on the LAN.

1. Click **Device Name** in Basic Mode home screen.
2. Enter or change the text in the **Device Name** and/or **Device Description** fields.
3. Click **Submit**.

The screenshot shows the 'Basic Mode' configuration page for 'Device Name'. The page has a blue header with the WD logo and navigation links for 'Advanced Mode', 'Help', and 'Logout'. Below the header, there is a breadcrumb trail 'Home | Device Name'. The main content area contains two input fields: 'Device Name' with the text 'f1nc-v032-1' and 'Device Description' with the text 'F1NC V0.3.2'. A 'Submit' button is positioned below these fields.

Date & Time

The date and time is synchronized automatically to the NTP (network time protocol) server by default. You have the option to set the date and time manually or allow the NTP to access the Internet to automatically set the time.



.....
Note: Time displays in 24-hour format only.

1. Click **Date & Time** in the Basic mode home screen.

2. Deselect **Enable** to set the time manually.

WD Advanced Mode | Help | Logout

Basic Mode

Home | Date & Time

Date & Time Jul 7 2008 13:43

NTP Service Enable

Submit

Copyright © 2008 Western Digital Technologies, Inc. All rights reserved.

3. To synchronize the date and time automatically, click **Enable**.
4. Click **Submit**.

WD Advanced Mode | Help | Logout

Basic Mode

Home | Date & Time

Date & Time Jul 7 2009 13:43

NTP Service Enable

NTP Time Server pool.ntp.org

Submit

Copyright © 2008 Western Digital Technologies, Inc. All rights reserved.

Network

The device's network mode is set to **DHCP Client** by default, which is appropriate for most environments. By selecting **Static IP**, you can manually set the IP address, netmask, gateway, and DNS (Domain Name Service) server IP address.

WD Advanced Mode | Help | Logout

Basic Mode

Home | Network

Network Mode DHCP Client

IP Address 172.25.102.67

Netmask 255.255.255.0

Default Gateway 172.25.102.254

DNS Servers 172.25.9.25
172.25.9.26

Submit

Copyright © 2008 Western Digital Technologies, Inc. All rights reserved.

To configure the network settings:

1. Click **Network** in the Basic mode home screen.
2. In the Network Mode drop-down menu, select a network mode. Selecting **DHCP Client** as a network mode causes the device to obtain an IP address automatically from the local DHCP server. Selecting **Static IP** as a network mode requires you to enter IP information such as IP address, Default Gateway, and DNS Servers.
3. Click **Submit**.

Users

Creating users allows the administrator to control access to data on WD ShareSpace across the network by creating user accounts with specific permissions. The administrator can also edit and delete user accounts in the **Users** menu.

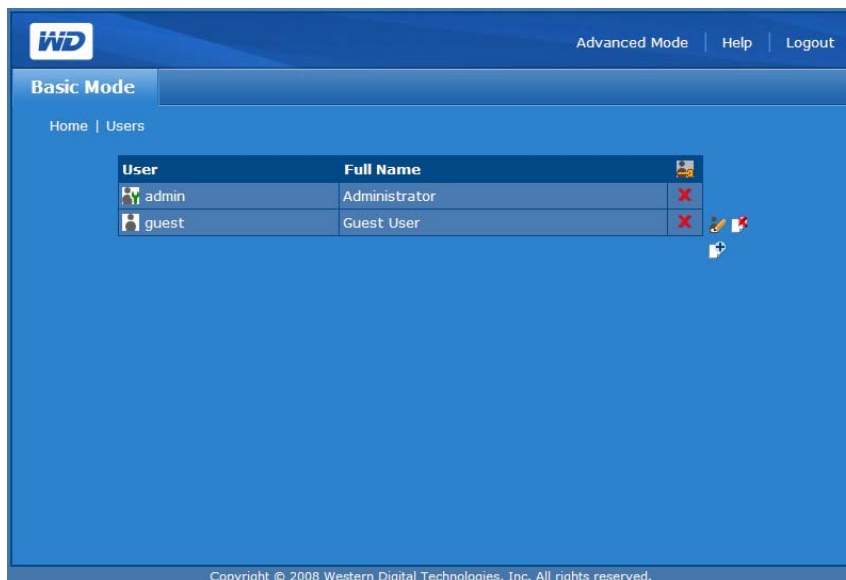
**Users Screen Icons**

Icon	Description
	Denotes a user private share.
	There is no private share with this user name.
	There is a private share with this user name.
	Click this icon to change the user password.
	Click this icon to delete a user.
	Click this icon to add a user.

To create a new user account:

1. Click **Users** in the Basic Mode home screen.
2. Click the Add icon .
3. Enter the user name in the **User Name** field.
4. Enter the user's full name in the **Full Name** field.
5. Enter the password in the **Password** field.



.....

Note: The maximum length of the password is 16 characters, including alphabetic, numeric, underscore, space, and most special characters except double-quote ("). The first and last characters cannot be a space. The password is case sensitive.

6. Re-enter the password in the **Confirm Password** field.
7. Create a private user share at the same time by clicking **Yes** next to **Create User Private Share**. The new user is granted full access to the private share. The private share name is the same as the user name.
8. Click **Submit**.

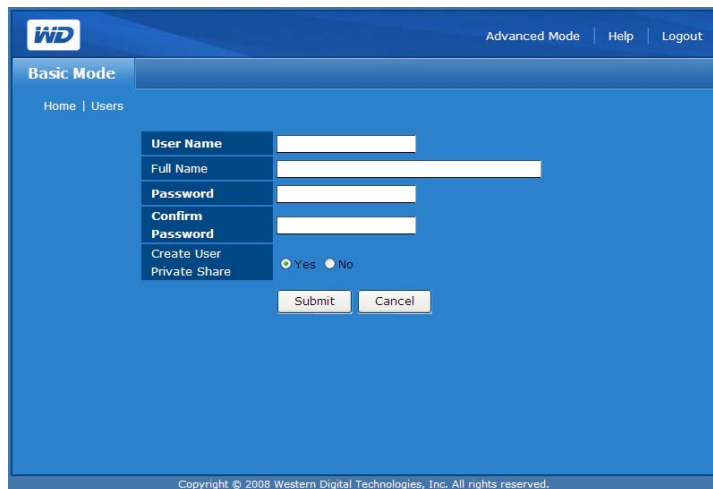
To change a user password:

1. Click the Change Password icon  next to the appropriate user account.
2. Make the necessary changes, and then click **Submit**.

To delete an existing user account:

1. Select the user account you want to delete, and then click the Delete icon .
2. Click **OK**.

For more user configuration options using the WD ShareSpace's Network Storage Manager Advanced Mode, see "Users" on page 128.

Folder Shares

Shares are folders that can be used to organize and store files on your WD ShareSpace. Shares can be shared with everyone (public) or with selected users on your network (private).

The device comes preconfigured with three shares:

- **Public**—created automatically at the factory
 - Shared Music - folder for storing music files you want to share with other users.
 - Shared Pictures - folder for storing image files you want to share with other users.
 - Shared Videos - for storing video files you want to share with other users.



.....

Important: Do not change or delete these default share folders. Disruption of file sharing could result. These are the default folders for the Media Server (Twonky Media) and iTunes Service. For more information on how to use Twonky media, see “Media Server” on page 125. For more information on how to use the iTunes service, see “iTunes” on page 126.

- **Download**—for saving files using Downloader (see “Scheduled Downloads” on page 141).
- **Configuration**—this is a read-only share containing only a Help file and the login page. It is not meant for sharing or storing data and should not be modified.





The administrator can create private shares accessible only by user name and password when setting up a user account (see page 82), or by setting permissions on an existing share (see “Folder Share Permissions” on page 131).

You must first access WD ShareSpace’s Network Storage Manager to create a share.

The Folder Shares menu provides access to a list of available shares.

Share	Volume	Description	
Download	DataVolume	Download Share	✗
Private	DataVolume	the private share of Private	✓
Public	DataVolume	Public Share	✗
usb1-1share1	USB Disk 1-1	USB Share	✗

Folder Shares Screen Icons

Icon	Description
	Denotes a user private share.
	This is a publicly accessible share.
	This is a private share.
	Click this icon to delete a share.
	Click this icon to add a share.

To create a share:

1. Click **Folder Shares** in the Basic mode home screen.
2. Click the Add icon  .
3. Enter a share name in the **Share** field. The share name can contain up to 32 characters, including alphabetic, numeric, or underscore characters.
4. Enter a brief description in the **Description** field.
5. Click **Submit**.

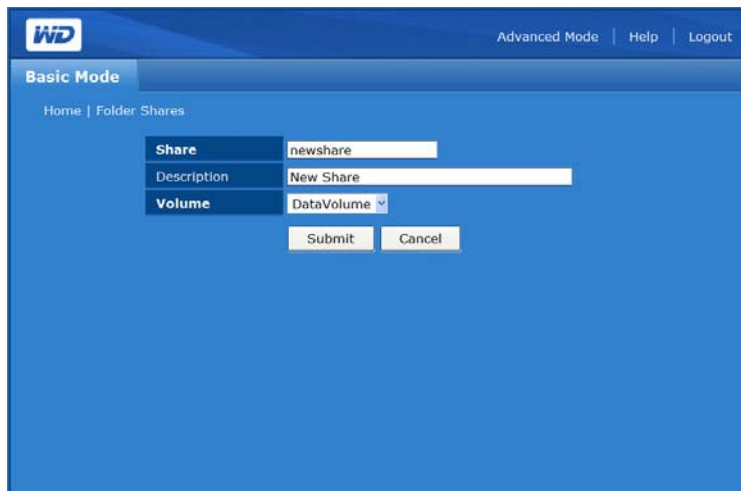

To delete existing shares:



.....
WARNING: Deleting a share erases all data on the share. All files and folders on the share will be lost.

1. Select the share to delete.
2. Click the Delete icon  .
3. Click **OK**.

System Status

The System Status option displays general information about the system: device name, firmware version, current date/time, system uptime, IP address, volume usage, and volume RAID type. Click System Status in the Basic Mode home screen to access system information

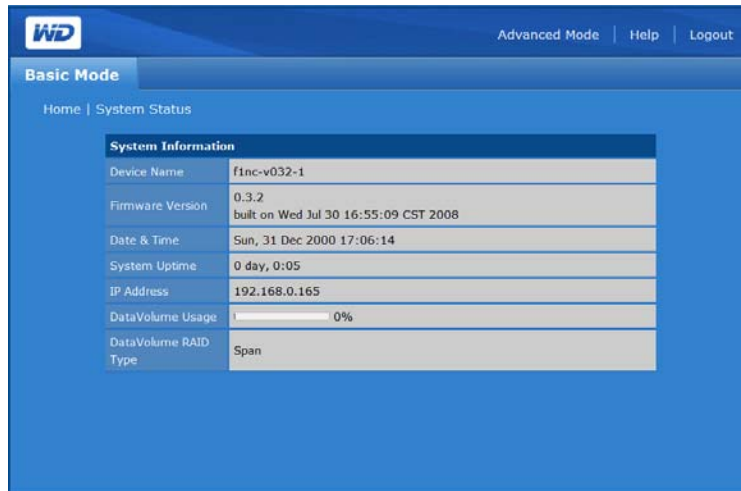

Remote Access

WD ShareSpace comes with MioNet enabled by default. The **Remote Access** option allows you to control the MioNet service on the storage device,

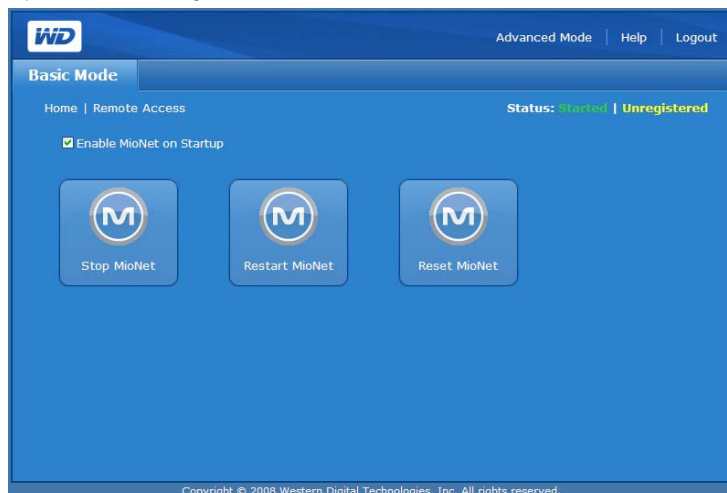

MioNet icons:

- Start/Stop MioNet - Shows Stop MioNet if MioNet is running and Start Mionet if MioNet is stopped.
- Restart MioNet - Stops MioNet if it is running and starts it again.
- Reset MioNet - Resets all MioNet account information on the WD ShareSpace. If the ShareSpace is registered to a MioNet account, that registration is erased so that the unit is now unregistered. This status will be displayed in the upper right corner of the page. Any shares created by MioNet or MioNet users will remain, and no data will be lost. Access to these shares over the LAN requires the use of the MioNet username and password.

MioNet service status messages:

- MioNet service connection status
 - Started - MioNet service is started
 - Stopped - MioNet service is stopped and will start on system restart.
 - Disabled - MioNet service is disabled and will not start on system restart.
- MioNet registration status
 - Unregistered - Not currently registered to a MioNet account
 - Registered - Already registered to a MioNet account



.....
Note: A mouse-over of the registration status shows the MioNet account name if the device is registered. To register with MioNet, go to: www.mionet.com/WDShareSpace.

Shutdown/Reboot

The Shutdown/Reboot options allow you to perform a system reboot or shutdown.

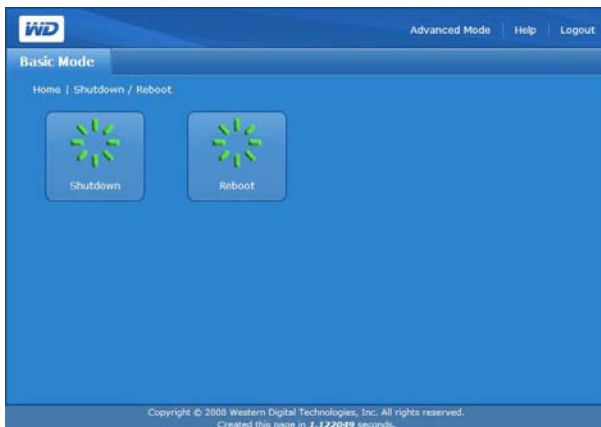

To perform WD ShareSpace shutdown:

1. Click **Shutdown/Reboot** in the Basic Mode home screen.
2. On the Shutdown/Reboot page, click **Shutdown**.
3. Click **OK**.

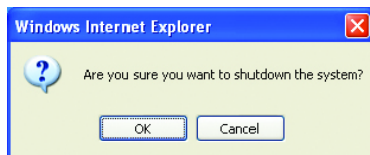

To perform WD ShareSpace reboot:

1. Click **Shutdown/Reboot** in the Basic Mode home screen.
2. On the Shutdown/Reboot page, click **Reboot**.
3. Click **OK**.

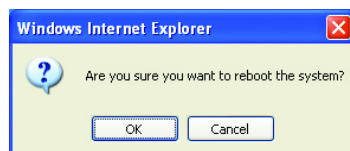

10

Network Storage Manager: Advanced

Advanced Mode provides access to additional options not available in the Basic Mode. When in Basic Mode, click **Advanced Mode** on the toolbar to view WD ShareSpace's Network Storage Manager in Advanced Mode.

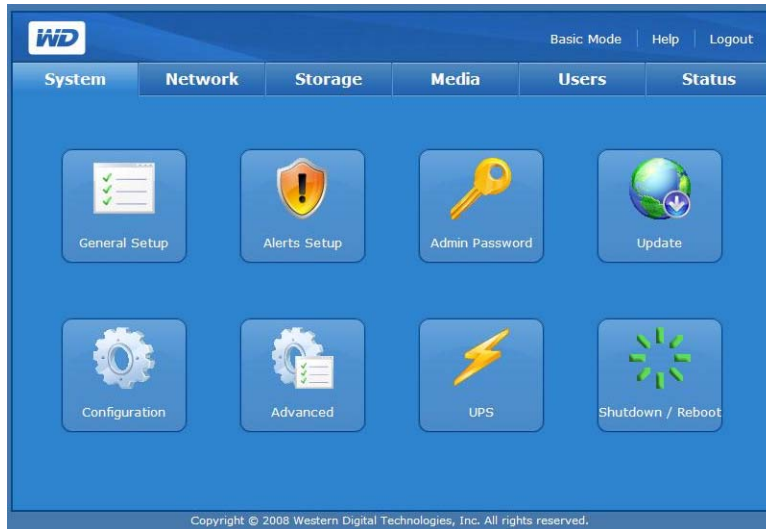

The Advanced Mode page include six tabs, each having several icons providing more management options for maximum flexibility and security of the device. The table below describes the tab options available in Advanced Mode.

Tab	Description
System	The System tab allows you to configure the general system settings, set e-mail or window alerts, change the administrator password, perform firmware upgrades, perform system configuration file backups, restore system to factory defaults, activate or deactivate the system LEDs, generate an SSL certificate, enable power saving, and perform device shutdown or reboot. For more details, see "System Tab" on page 88.
Network	The Network tab has access to all network configuration options, such as setting DHCP / Static mode, changing the IP address, netmask, gateway, DNS server IP address, configuring jumbo frames, and configuring membership in a domain or workgroup. For more details "Network Tab" on page 101.
Storage	The Storage tab provides a list of all supported drives it locates on the system. It also allows you to configure the RAID capability of the hard drives, manage file share preferences, set the backup destination folder, set disk quotas, and set a share folder for users. For more details, see "Storage Tab" on page 109.
Media	The Media tab allows you to enable or disable the streaming option in iTunes or access the Twonky Media server. For more details, see "Media Tab" on page 125.
Users	The Users tab allows you to add, modify, and delete users and groups, and change all user and group permissions (read/write, read only, no access) to shares/folders and USB storage devices. For more details, see "Users Tab" on page 128.
Status	The Status tab displays general information about the system such as device name, firmware version, current date/time, machine up-time, memory and swap activity, and load averages. This tab also allows viewing of logs from the system, Common Internet File System (CIFS), or File Transfer Protocol (FTP). For more details, "Status Tab" on page 136.

System Tab

The **System** tab allows you to set the system date and time, set up alerts, change the admin password, perform software or firmware upgrades, create a backup copy of the system files, restore the system to factory defaults, generate and set up an SSL certificate, or perform system reboot or shutdown.

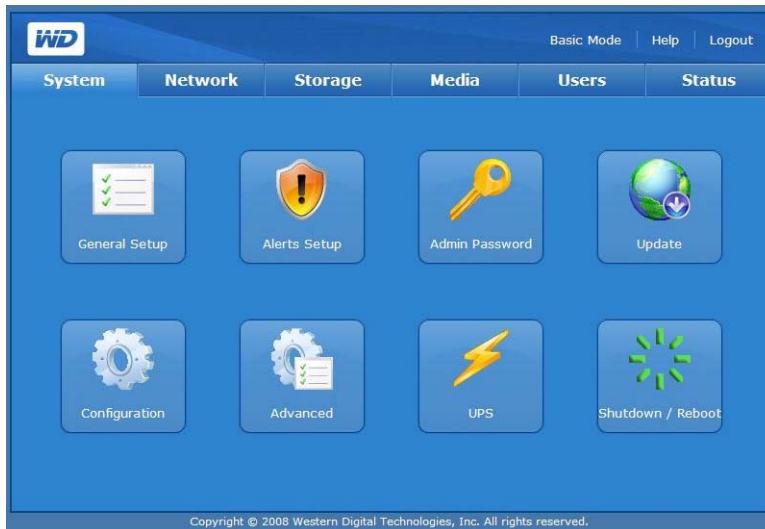

The **System** tab provides access to the following configuration options:

- General Setup
- Alerts Setup
- Admin Password
- Update
- Restore Configuration
- Advanced
- UPS
- Shutdown/Reboot

General Setup

The General Setup icon on the **System** tab allows you to perform basic configuration of device. You can provide a name and brief description for the device, select a compatible web access protocol, and set the time zone. You can set the date and time manually or enable automatic time synchronization by NTP (Network Time

Protocol) Service. You can also manually specify the IP address of the NTP servers to which you want to synchronize.

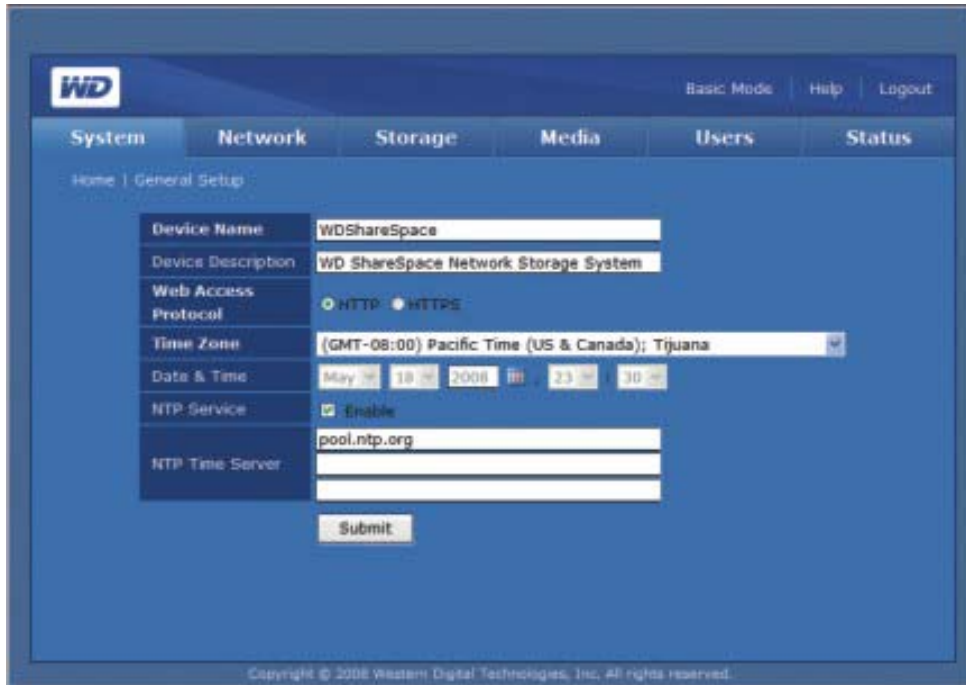

The screenshot shows the 'General Setup' configuration page for a WD ShareSpace Network Storage System. The interface is in 'Basic Mode' and includes a 'Logout' link. The main navigation tabs are System, Network, Storage, Media, Users, and Status. The 'General Setup' page contains the following fields and options:

- Device Name:** WDSHareSpace
- Device Description:** WD ShareSpace Network Storage System
- Web Access Protocol:** HTTP (selected), HTTPS
- Time Zone:** (GMT-08:00) Pacific Time (US & Canada); Tijuana
- Date & Time:** May 18, 2008, 11:23:30
- NTP Service:** Enable
- NTP Time Server:** pool.ntp.org

A 'Submit' button is located at the bottom of the form. The footer of the page reads: Copyright © 2008 Western Digital Technologies, Inc. All rights reserved.

To configure system general setup settings:

1. Assign a device name for this storage device in the **Device Name** field. The device name can contain up to 15 characters, including alphabetic, numeric, and hyphens only.
2. Enter a brief description for this storage device in the **Device Description** field. The maximum length of the description must not be more than 256 alphanumeric characters.
3. In web access protocol, select either of the following web access protocols:
 - **Hypertext Transfer Protocol (HTTP)** is a communications protocol for the transfer of information on the intranet and the World Wide Web.
 - **Hypertext Transfer Protocol over Secure Socket Layer** or **HTTPS** is a URL scheme used to indicate a secure HTTP connection. HTTPS is syntactically identical to the http:// scheme normally used for accessing resources using HTTP. All traffic between the managing computer and the WD ShareSpace is encrypted. HTTPS provides a more secure means of configuring your device, but it may affect the responsiveness of the user interface.
4. To set the date and time manually, deselect **Enable** next to NTP Service.
5. Select a time zone from the **Time Zone** list.
6. Adjust the date and time manually in the **Date & Time** lists.
7. Click **Submit**.

Alerts Setup

Using the Alerts Setup icon on the System tab, you can configure e-mails or popup messages that provide alerts for system conditions such as over temperature; hard drive, volume, network, and USB status; and user and group events. These alerts help the system administrator(s) manage and detect events or errors.

WD Basic Mode Help Logout

System Network Storage Media Users Status

Home | Alerts Setup

Email Notification Enable

Pop-Up Notification Enable

Submit

Note:

1. Please make sure all settings are valid by pressing the 'Send Test Mail' or 'Send Test Pop-up' buttons before submitting the changes.
2. Only computer name is allowed for 'Notified Devices'.
3. Pop-Up Notification applicable to Windows XP only.

To set up automatic e-mail notifications:

1. Click **Enable** next to Email Notification. The page displays additional fields.

WD Basic Mode Help Logout

System Network Storage Media Users Status

Home | Alerts Setup

Email Notification Enable

SMTP Server

SMTP Port 25 (Default: 25)

TLS/SSL Enable

SMTP Authentication Enable

Email Return Path

Email Recipients

Send Test Mail

Pop-Up Notification Enable

Submit

Note:

1. Please make sure all settings are valid by pressing the 'Send Test Mail' or 'Send Test Pop-up' buttons before submitting the changes.
2. Only computer name is allowed for 'Notified Devices'.
3. Pop-Up Notification applicable to Windows XP only.

2. In the **SMTP Server** field, enter the name or IP address of the SMTP server used for e-mail. (Check with your Internet Service Provider (ISP) for the SMTP server settings, which may include the SMTP port, and ask whether to enable TLS/SSL or SMTP authentication.)
3. In the **Email Return Path** field, enter a valid return email address recognized by your ISP. For example, if your SMTP server is "smtp.myisp.net", then you should enter a valid return email path address of the form "myname@myisp.net".
4. In the **Email Recipients** field, enter the e-mail address where you want to send an e-mail message when an event occurs. Up to five e-mail addresses can be used at a time.
5. Click **Send Test Mail** to send a test alert and confirm your settings are correct. A test message will be sent to each entered e-mail address.
6. Click **Submit**.

To configure alerts to send pop-up messages when an event occurs:



.....

Note: Pop-up notification only works with Windows XP.

For a list of events, see "System Events" on page 156.

1. On the Alerts Setup page, click **Enable** next to Pop-Up Notification.
2. Enter the name of the computer in the **Notified Devices** field. When an event occurs, a pop-up message will appear on the computer. Up to five computer names can be added to the alert list.



.....

Note: To find the name of your computer, click **Start** and right-click **Computer** or **My Computer**, click **Properties**, and then click the **Computer Name** tab (Windows XP).

3. Click **Send Test Pop-up** to send a test alert and confirm that the settings are correct.



.....

Note: Make sure the Messenger Service is activated on the computers to which you want to send the pop-up message when an event occurs. To enable Messenger Service, go to **Start > Control Panel > Administrative Tools > Services > Messenger**. You can test the Messenger Service by clicking **Send Test Pop-up**. Make sure printer and file sharing is selected as an exception if the Windows Firewall is enabled in Windows 2000/XP.

4. Click **Submit**.

Home | Alerts Setup

Email Notification Enable

Pop-Up Notification Enable

Notified Devices

Send Test Pop-Up

Submit

Note:

1. Please make sure all settings are valid by pressing the 'Send Test Mail' or 'Send Test Pop-up' buttons before submitting the changes.
2. Only computer name is allowed for 'Notified Devices'.
3. Pop-Up Notification applicable to Windows XP only.

Admin Password

The Admin Password icon on the **System** tab allows you to change the administrator's password.

Home | Admin Password

Old Password

New Password

Confirm Password

Submit

Copyright © 2001 - 2008 Western Digital Corporation. All rights reserved.

To change the administrator's password:

1. In the **Old Password** field, enter the old password.
2. In the **New Password** field, enter the new password. The maximum length of the password is 16, including alphabetic, numeric, underscore, space, and most special characters except double-quote ("). The first and last characters cannot be a space. The password is case sensitive.
3. In the **Confirm Password** field, re-enter the new password.
4. Click **Submit**.

Update (Firmware)

The Update icon on the **System** tab provides information about the current firmware version and allows you to perform a firmware update either automatically or manually.

Automated

The **Automated** tab on the Update page provides information about the current firmware version and connects to the WD website for automatic downloading of the latest firmware.

1. Click **Check For New Firmware**.

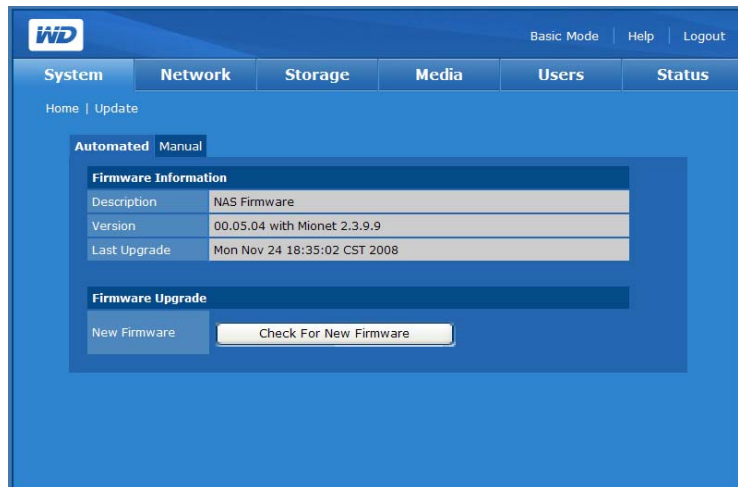

2. Click **Download** if new firmware is available.

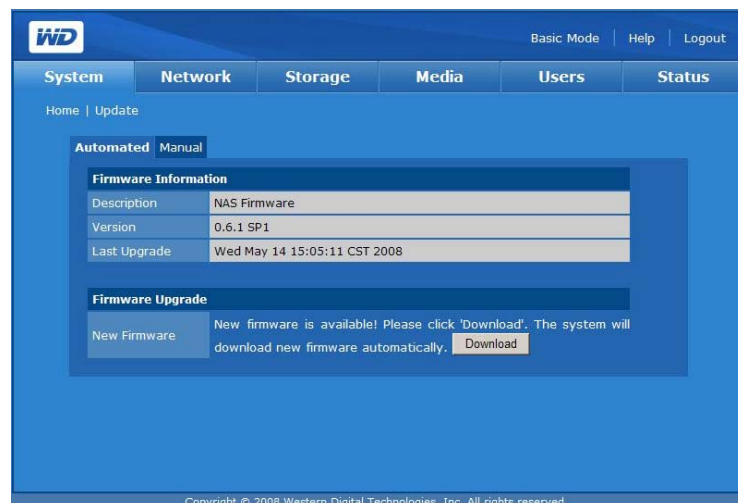

3. Click **Upgrade**. Wait for the update process to complete.



.....

WARNING! Do not interrupt a firmware upgrade in progress; doing so may cause the device to malfunction or render it unable to boot.

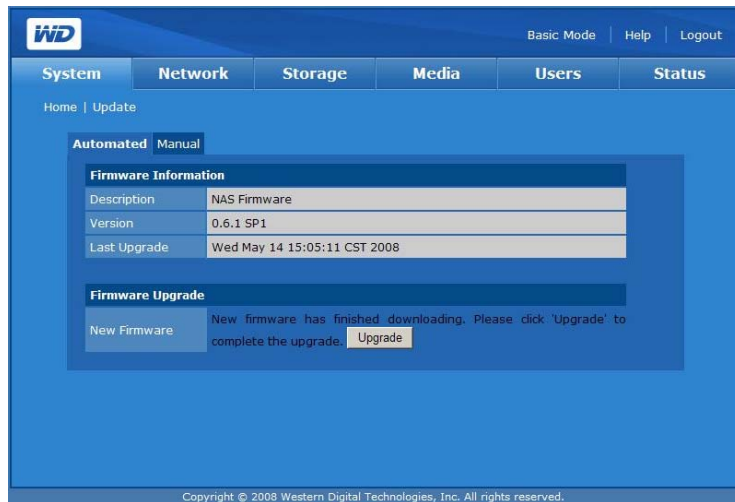

After your firmware has been updated, the device will reboot. The user interface redirects to the System Information page after the update has completed.

Manual

The Manual option allows you to install the firmware manually.

1. Before attempting a manual update, check support.wdc.com for firmware availability.
2. If a new firmware file is available, download it from support.wdc.com.

After your firmware has been updated, the device will reboot. The web user interface redirects to the System Information page after the update is completed.

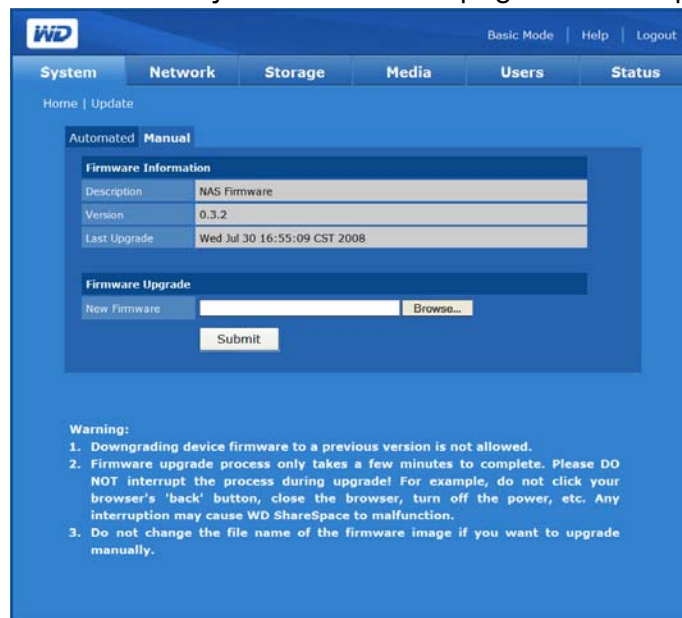

.....
Note: If the IP address of your unit has changed, you will need to use WD Discovery Tool to discover it again.

Configuration

The Configuration icon allows you to save or restore system configuration settings or revert to factory default settings.

To back up the current system configuration settings:

1. On the Restore Configuration page, click **Save Current Configuration**.

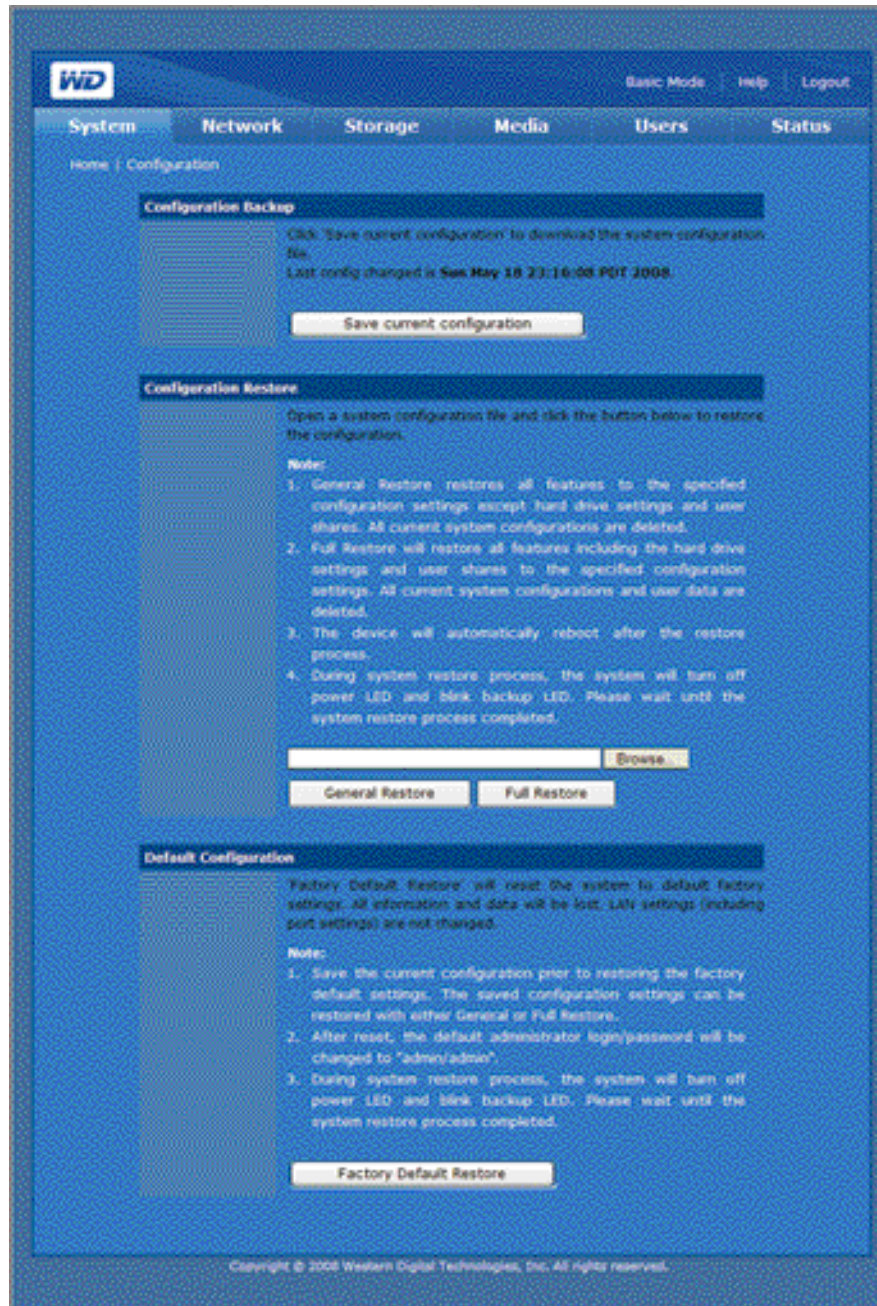

2. Specify a file name and location for saving the file.
3. Click **Save**.

To restore saved configuration settings:

1. On the Restore Configuration page, click **Browse**.
2. Select the previously saved system configuration file.
3. Click **Open**.
4. Click **General Restore** or **Full Restore**. Selecting General Restore will restore all features to previously saved settings (data volume and shares settings excepted). All current system configurations will be lost. Full Restore restores all features, including the data volume and shares, to previously saved settings. All current system configurations and user data is lost when using Full Restore.
5. Click **OK**.

To restore the device to factory defaults:

.....
Important: Save the current configuration prior to restoring the factory default settings.

Performing a factory default reset will erase all settings in the WD ShareSpace. System configuration will reset the device to default factory settings. **All information and data will be lost.** The LAN settings (including port settings) are not changed. After the reset, the administrator login/password will be changed to "admin/admin."

1. On the Configuration page, click **Restore Factory Default**.
2. Click **OK**.

During the system restore process, the system will turn off the power LED and blink the backup LED. Wait until the system restore process is completed.



.....
Note: You cannot access the configuration web pages if you forget the administrator password, IP address setting, or device name. Use the reset button to restore these settings (including IP setting, device name, and administrator password) to factory default configuration. To use this function, press and hold the reset button on the back of the device (next to power interface) for at least 10 seconds. The system reboots automatically and you can then use the default settings to access the device.

Advanced

The Advanced icon on the **System** tab allows you to configure the device's identification LED and configure the system for a secure connection by generating a key and an SSL certificate. You can also set the extend Span mode and enable HDD standby mode.

The screenshot shows the WD Network Storage Manager interface. At the top, there's a navigation bar with 'System', 'Network', 'Storage', 'Media', 'Users', and 'Status' tabs. Below this, there's a 'Home | Advanced' breadcrumb. The main content area is divided into several sections:

- System Identification:** Includes a 'Turn LED' toggle with 'ON' selected and 'OFF' unselected.
- Certificate:** Contains two text input fields: 'SSL Certificate/key' with the placeholder 'Paste a signed certificate in X.509 PEM format here.' and 'Key' with the placeholder 'Paste a RSA private key in PEM format here.'. Below these is an 'Auto Generate' link with the text 'Click [HERE](#) to generate a new SSL certificate and key pair automatically.' and a 'Submit' button.
- Extend Span:** Features a 'Mode' dropdown menu currently set to 'Auto Extend' and a 'Submit' button.
- Power Saving:** Includes an 'HDD Standby' checkbox that is checked, with the text 'Enable' next to it, and a 'Submit' button.

To turn on the system identification LED:

System Identification identifies the location of the device. If you have multiple devices installed, you can use this function to turn on the identification LED and know which device you are configuring.

1. Click **ON** to enable the system identification LED.

To generate an SSL certificate and key pair automatically:

1. Click **HERE** In the **Auto Generate** field of the SSL certificate/key. The SSL Certificate/Key Generation dialog appears.



2. Enter the identification information you want to include in the certificate/key pair.
3. Click **Submit**.

To generate an SSL certificate and key pair manually:

1. Using your preferred method, generate an RSA private key and paste it in the appropriate fields.
2. Click **Submit**.

To select extend disk mode:

1. Select **Auto Extend** or **Manual (Extend Disk) Mode**:

Auto Extend only applies when RAID type is Span. It will extend an existing Span automatically when you add a new drive and reboot the system. Manual allows you to choose when to add the new drive after boot up.

2. Click **Submit**.

To enable HDD standby:

If the HDD Standby function is enabled, the hard drives go into standby mode to save power after a fixed period of no activity. This period varies from 125 seconds to 375 seconds.

1. Click **Enable** next to HDD standby.
2. Click **Submit**.



.....
Note: The Power Save feature allows drives to spin down when not in use. The fan will continue to operate.

3. Enter the identification information you want to include in the SSL certificate/key pair, and then click **Submit**.

UPS

A UPS (uninterruptable power supply) device can be connected to one of the USB ports to shut down the ShareSpace in the event of a power failure. You must connect the UPS device to the WD ShareSpace before setting up the UPS service.



.....
Note: Go to support.wdc.com and search the knowledge base for answer ID 2559 for a list of compatible UPS devices.

UPS Setup

The **UPS Setup** tab allows you to modify UPS settings.

To enable the UPS service:

1. Click the **UPS Setup** tab.
2. Click **Enable** in UPS service.
3. Enter the timeout value.
4. Click **Submit**.



.....
Note: During a power failure, the system will shut down after TIMEOUT seconds have expired, or the remaining battery percentage reaches 15% or less, or the remaining battery runtime drops to or below 5 minutes. A value of '0' disables the Timeout timer.

The screenshot shows the WD ShareSpace web interface. At the top, there is a navigation bar with the WD logo on the left and 'Basic Mode', 'Help', and 'Logout' on the right. Below this is a menu with tabs for 'System', 'Network', 'Storage', 'Media', 'Users', and 'Status'. The 'System' tab is selected, and the breadcrumb path is 'Home | UPS'. Under the 'UPS' section, there are two sub-tabs: 'UPS Status' and 'UPS Setup', with 'UPS Setup' being the active tab. The 'UPS Setup' form contains the following elements: a 'UPS Service' section with a checked 'Enable' checkbox; a 'Timeout' section with a text input field containing '60' and the label 'Shutdown after 60 Seconds (Default: 0)'; and a 'Submit' button. Below the form, there is a 'Note:' section with a single bullet point: '1. A value of 0 disables the 'Timeout' timer.'

UPS Status

The **UPS Status** tab provides information about the connected UPS device, including model, battery level and runtime, timeout, and status.



Shutdown/Reboot

The Shutdown/Reboot menu allows you to perform system reboot or shutdown.



To perform WD ShareSpace shutdown:

1. Click **Shutdown/Reboot** in the **System** tab home screen.
2. On the Shutdown/Reboot page, click **Shutdown**.
3. Click **OK**.

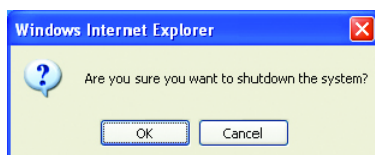

To perform WD ShareSpace reboot:

1. Click **Shutdown/Reboot** in the **System** tab home screen.
2. On the Shutdown/Reboot page, click **Reboot**.
3. Click **OK**.

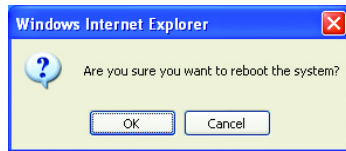
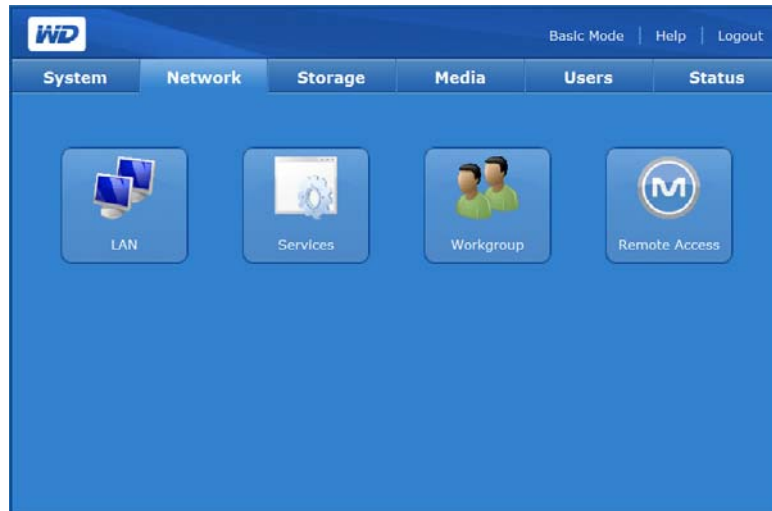
**Network Tab**

The **Network** tab provides access to the following configuration options:

- LAN
- Services
- Workgroup
- Remote Access

LAN

The LAN icon on the **Network** tab allows access to all network configuration options including setting the connection method, changing the IP address, netmask, gateway, and DNS (Domain Name Service) server IP address, as well as changing the MTU size to enable jumbo frames.

WD Network Settings interface showing the following configuration:

Network Mode	DHCP Client
IP Address	192.168.1.2
Netmask	255.255.255.0
Default Gateway	192.168.1.250
DNS Servers	68.105.28.11 68.105.29.11
MTU Size (Bytes)	1500 (Default: 1500)

Note:
1. For an MTU size larger than '1500', the client machine and network switch must support the same MTU size. The common MTU size for jumbo frame is '9004'. The rule for calculating valid MTU is $(MTU\ size - 1500) \bmod 8 = 0$. ('xxx mod 8' means the value 'xxx' can be divided by 8).

To configure the network settings:

1. In the Network Mode drop-down menu, select a network mode. Selecting DHCP Client as a network mode will cause this storage device to obtain an IP address automatically from the local DHCP server. Selecting Static IP as a network mode requires you to assign IP information such as IP address, Default Gateway, and DNS Servers.
2. If your network link speed is 1000 Mbps, the MTU field will be available. Enter the MTU (Maximum Transmission Unit) value for the jumbo frame. The default MTU setting is 1500 bytes. Any value larger than this is considered a jumbo frame. The network card on the client computer must support jumbo frames.



.....

Note: For the MTU size larger than 1500, the client machine and the network switch must also support the same MTU size. The common MTU size for jumbo frame is '9004'. The rule for calculating valid MTU is $(MTU\ size - 1500) \bmod 8 = 0$ ('xxx mod 8' means the value 'xxx' can be divided by 8).

The range of valid IP addresses for each class:

- Class A: 1.0.0.1 to 126.255.255.254
- Class B: 128.1.0.1 to 191.255.255.254
- Class C: 192.0.1.1 to 223.255.254.254

3. Click **Submit**.

Services

The **Services** icon on the **Network** tab allows you to set protocols for sharing files and folders on the device.

The screenshot shows the 'Services' configuration page in the WD Network Storage Manager. The page is titled 'Home | Services' and has a navigation bar with tabs for 'System', 'Network', 'Storage', 'Media', 'Users', and 'Status'. The 'Network' tab is selected. The page is divided into several sections for different services:

- UPnP for Web Access & FTP:** A checkbox labeled 'Service' is checked 'Enable'.
- Web Access:** Two radio buttons are selected 'Default'. Below them are two input fields for port ranges, both showing '00 through 10000'.
- FTP:** A checkbox labeled 'Service' is checked 'Enable'. Below it is a radio button selected 'Yes' for 'Enable Anonymous'. Another radio button is selected 'Default' for 'Port', with an input field showing '00 through 10000'.
- NFS:** A checkbox labeled 'Service' is checked 'Enable'. Below it is an input field for 'IP Allowed' with an 'Add' button. To the right of the input field are buttons for 'Modify', 'Delete', and 'Delete All'.
- AFP:** A checkbox labeled 'Service' is checked 'Enable'. Below it is a 'Submit' button.

Note:

1. Enabling the UPnP NAT traversal may delay system response time during Web/FTP port changing.
2. No access allowed for NFS if the IP allowed list is empty.
3. Mount point for NFS share is /nfs/SHARENAME, Ex. /nfs/Public

- **Universal Plug and Play (UPnP)** is a set of computer network protocols that simplifies the implementation of networks in the home by allowing devices to connect seamlessly.
- **File Transfer Protocol (FTP)** is a network protocol used to transfer data from one computer to another through a network. FTP is a popular choice for exchanging files independent of the operating systems involved.
- **Network File System (NFS)** is a network file system protocol that allows a user on a client computer to access files over a network as easily as if the network devices were attached to its local disks. Generally used on UNIX systems.
- **Web Access**
 - **Hypertext Transfer Protocol (HTTP)** is a communications protocol for the transfer of information on the intranet and the World Wide Web.
 - **Hypertext Transfer Protocol over Secure Socket Layer** or **HTTPS** is a URL scheme used to indicate a secure HTTP connection. It is syntactically identical to the http:// scheme normally used for accessing resources using HTTP.

To enable UPnP NAT Traversal for Web Access & FTP:

1. Click **Enable** in UPnP for Web Access & FTP.
2. Click **Submit**.

The UPnP NAT Traversal combines with the UPnP feature and NAT feature. Universal Plug and Play (UPnP) is an architecture for pervasive peer-to-peer network connectivity of PCs and intelligent devices. The Network Address Translation (NAT) is used in gateway devices that form the boundary between the public Internet and the private LAN. As IP packets from the private LAN traverse the gateway, NAT translates a private IP address and port number to a public IP address and port number, tracking those translations to keep individual sessions intact.

To enable other network services:

1. Click **Enable** in network service.
2. If you have selected **FTP** as your network service, click **Yes** to enable or click **No** to disable anonymous login, and then click **Submit**.
3. If you have selected **NFS** as your network service, the **IP allowed** field appears. You will be prompted to enter the IP filters that are allowed for NFS service. Click **Add** to add a new IP filter, and then click **Submit**.



.....

Note: In **IP Allowed** field of NFS service, '*' means allow all IP addresses. If you intend to allow specified IP addresses or range, please modify '*' in **IP Allowed** field.
Mount point for NFS share is /nfs/SHARENAME, Ex. /nfs/Public.

4. You can specify particular port numbers for **HTTP**, **HTTPS**, and **FTP** services respectively. Instead of selecting the **Default** radio button, you can specify the port number between 8000 and 10000 for each service.



.....

Note: In **IP Allowed** field of NFS service, '*' means allow all IP addresses. If you intend to allow specified IP addresses or range, please modify '*' in **IP Allowed** field.
Mount point for NFS share is /nfs/SHARENAME, Ex. /nfs/Public.

To access data via FTP:

You can access data in a shared folder on WD ShareSpace with a widely used FTP client software program. An FTP client software program must be installed on the computer you are using to access the device, and FTP service must be enabled on the WD ShareSpace (see “To enable other network services:” on page 104 and “To modify properties of the share:” on page 118 for details).

1. Open an FTP client software program.
2. Enter ftp://username@IP address as the host name (e.g., ftp://admin@172.25.102.67) or just the device's IP address depending on the FTP client software program you are using.



.....

Note: Click **System Status** in either the basic or Advanced Mode to view the device's IP address.

3. Enter the WD ShareSpace user name and corresponding password.
4. Click **Connect** or **OK**.

You can now upload files to or download files from WD ShareSpace across the LAN. It is possible to upload files to or download files from WD ShareSpace across the Internet (WAN), but this requires custom router configuration and is recommended only for advanced users.

Workgroup

The Workgroup icon on the **Network tab** allows you to set up the network storage device as a workgroup or a domain member. The default setting is Workgroup.

Domains are controlled from a central location (domain controller) and require central authentication before you can join them. Workgroups, in contrast, are much simpler to control. As long as you know the workgroup name, you can add any computer to a workgroup.

If your network uses a domain (has a Windows 2003 Active Directory Service (ADS)), you may wish to connect this device as a domain member. When configured as a domain member, the device will ask the ADS to authenticate users. Therefore, as a domain member, the device provides user-level security.

ADS enables the administrator to manage users' permissions in a central location and to propagate these permissions to multiple devices. For example, any device that has a domain on ADS inherits the user list and associated permissions.

When joining a domain, the device must be authorized by the domain's administrator. You must enter the fully qualified Domain Name, Domain Controller IP Address, Domain Administrator Name, and Domain Administrator Password for the authorization.

To set up a workgroup name:

1. Click **Workgroup** as the **Mode** option.
2. Enter a name for your workgroup in the **Workgroup Name** field.
3. Click **Submit**.

The screenshot shows the WD Sharespace interface with the 'Workgroup' configuration page. The 'Mode' is set to 'Workgroup' (selected with a radio button) and 'Domain Member' is unselected. The 'Workgroup Name' field contains 'WORKGROUP'. A 'Submit' button is visible below the form.

To join a domain (Windows 2003 Server only):

1. Click **Domain Member**.
2. Enter the fully qualified domain name in the **Domain Name** field.
3. Enter the domain administrator IP address in **Domain Controller IP Address** field.
4. Enter the domain administrator name in the **Administrator** field.
5. Enter the domain administrator password in the **Administrator Password** field.



.....

Note: The local user and domain user share the same access control rights if the user name of the local and domain users are the same (FTP service excluded).

6. Click **Submit**.

The screenshot shows the WD Sharespace interface with the 'Domain Member' configuration page. The 'Mode' is set to 'Domain Member' (selected with a radio button) and 'Workgroup' is unselected. The 'Domain Name' field contains 'CAE-Server.CAE.local', 'Domain Controller IP Address' contains '192.168.23.143', 'Administrator' is masked with dots, and 'Administrator Password' is also masked with dots. A 'Submit' button is visible below the form.

When the process is complete, a confirmation message appears.

If changes are made at the Active Directory server to either users or groups or both, you can manually update the list on the WD ShareSpace. (See “Folder Share Permissions” on page 131.)



Note: You can enable ADS to automatically update the WD ShareSpace. Contact WD Tech Support for more information on this procedure.

Remote Access

WD ShareSpace comes with MioNet enabled by default. If MioNet is not already installed on the client computer, follow the instructions under “Configuring WD ShareSpace” on page 69. The **Remote Access** icon allows you to control the MioNet service on the storage device.

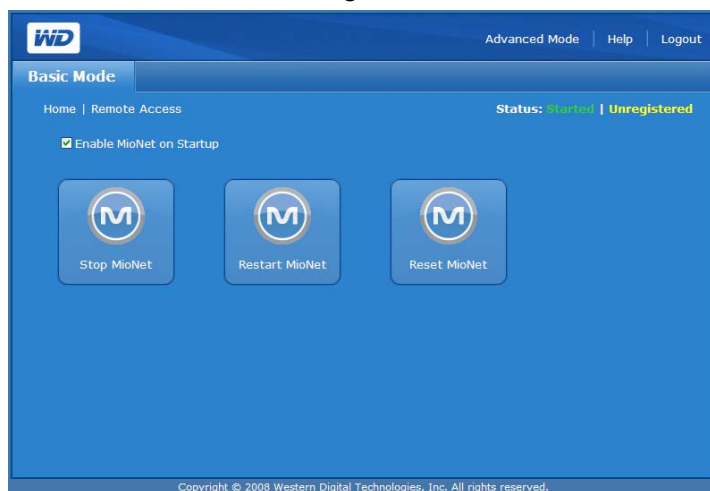

MioNet Icons

- Start/Stop MioNet - Shows Stop MioNet if MioNet is running and Start Mionet if MioNet is stopped.
- Restart MioNet - Stops MioNet if it is running and starts it again.
- Reset MioNet - Resets all MioNet account information on the ShareSpace. If the ShareSpace is registered to a MioNet account, that registration is erased so that the unit is now unregistered. This status will be displayed in the upper right corner of the page. Any shares created by MioNet or MioNet users will remain, and no data will be lost. Access to these shares over the LAN requires the use of the MioNet username and password.

MioNet service status messages:

- **MioNet service connection status**
 - Started - MioNet service is started
 - Stopped - MioNet service is stopped and will start on system restart.
 - Disabled - MioNet service is disabled and will not start on system restart.
- **MioNet registration status**
 - Unregistered - Not currently registered to a MioNet account
 - Registered - Already registered to a MioNet account



.....

Note: A mouse-over of the registration status shows the MioNet account name if the device is registered. To register with MioNet, go to: www.mionet.com/WDShareSpace.

Storage Tab

The **Storage** tab provides all necessary options required for individual storage disk configuration and maintenance. This tab also includes an option to change the system's RAID configuration, set a share name, and format and safely remove the USB drives connected to the system.



The **Storage** tab provides the following configuration options:

- Disk Manager
- Volumes & RAID Management
- Folder Shares
- USB Shares
- Quota
- Downloads

Disk Manager

The Disk Manager icon on the **Storage** tab displays the installed hard drives in the device. This page also displays detailed information about each drive, such as disk size, disk description, and status.

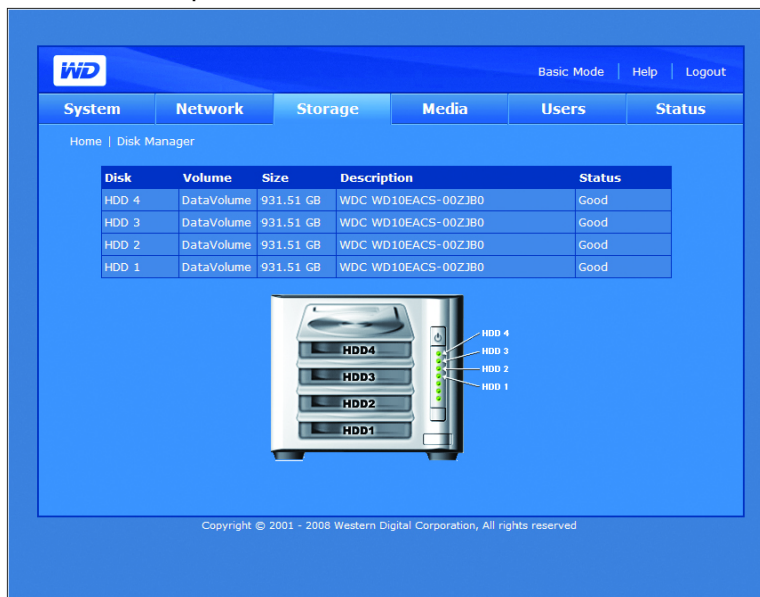

Drive status messages include the following:

- **Good**—Indicates the hard drive is accessible and functioning normally.
- **Failed**—Indicates a fatal error has occurred on the hard drive(s). See “Replacing a Drive” on page 147 for drive replacement instructions.
- **Foreign**—Indicates the device has detected a hard drive that was used on another computer.

To clean up a disk:

If the hard drive is foreign or used, the Clean Disk  icon appears on the right side of the Disk Management table. Clean Disk erases the previous partition to allow creation of a new volume.

To safely remove a disk:

If the hard drive is not part of an existing volume, the Safely Remove Disk  icon appears on the right side of the Disk Management table and allows you to safely remove the drive.

Volumes and RAID Management

The Volumes page includes two tabs—**Manage Volume** and **Manage RAID**.

Manage Volume

The **Manage Volume** tab lists all the volumes available on the device and provides detailed information about each volume such as description, RAID type, usage, size, and volume status.

Volume	Type	Disk	Usage	Size	Status
DataVolume	Raid 5		0%	2.68 TB	Good



Note: If the volume RAID type is Span and there are new disks in the system, the Extend icon appears on the side of the Manage Volume table.

Volume	Type	Disk	Usage	Size	Status
DataVolume	Mirror		Unknown	Unknown	Resyncing

Status [Close](#)
 Rate of Progress = 27.1%,
 Estimate Time = 165.1 min,
 Disk Speed = 71674 K/sec

Volume status messages include the following:

- **Good**—Indicates the volume is accessible and hard drive is functioning normally.
- **Failed**—Indicates a volume cannot be started automatically, the disk may be damaged or the file system may be corrupt.
- **Resyncing**—Occurs when creating a mirror or when a mirrored volume is being resynchronized.
- **Formatting**—Indicates volume is being formatted.
- **Degraded**—Missing one drive in a RAID 1 or RAID 5 configuration.
- **Recovering**—The failed drive is being copied to a working drive in a RAID 1 or RAID 5 configuration.

To display more detailed information, click on an underlined status.

To modify the volume:

1. Click the **Manage Volume** tab.
2. Click the Modify  icon next to the volume you want to modify. The Volume & Raid Management page appears.

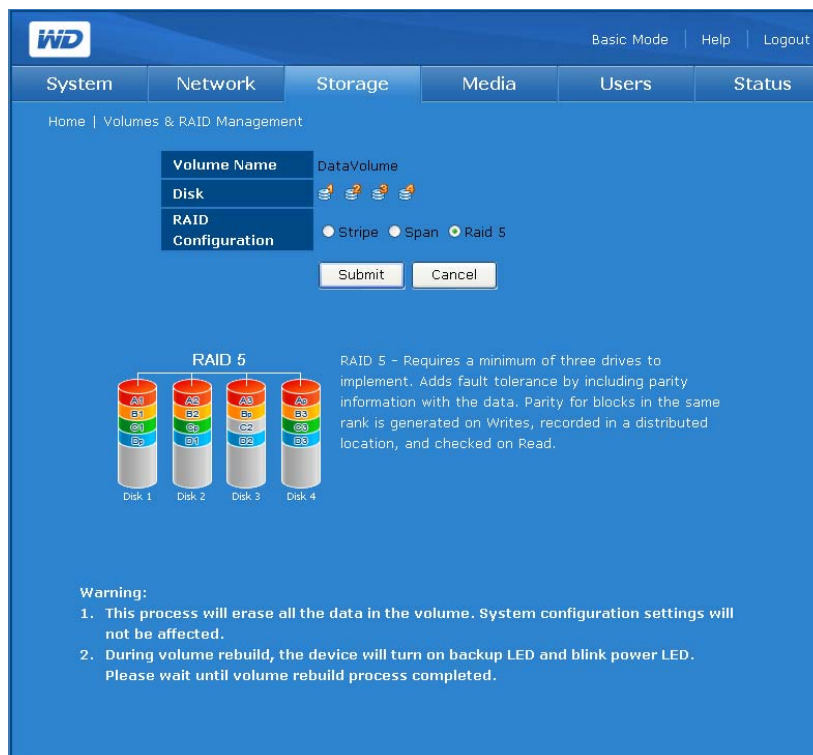

3. Select a RAID level.
4. Click **Submit**.

To delete a volume:

1. Click the Delete  icon.
2. Click **OK**.



.....
Note: Only ExtendVolume can be deleted.

Manage Volume Options

The table below shows available volumes for systems containing one to four drives.

Manage Volume available options	starting mode	+ 0 Drives	manual extend span available	+ 1 Drive	manual extend span available	+ 2 Drives	manual extend span available	+ 3 Drives	manual extend span available	- 1 drive	- 2 drive	- 3 drive
1 Drive	span	span	no	span, stripe, mirror	yes	span, stripe, RAID 5	yes	span, stripe, RAID 5, two mirrors	yes			
2 Drive	span	span, stripe, mirror	no	span, stripe, RAID 5	yes	span, stripe, RAID 5	yes			span		
2 Drive	mirror	span, stripe, mirror	no	span, stripe, RAID 5	no	span, stripe, RAID 5	no			span		
2 Drive	stripe	span, stripe, mirror	no	span, stripe, RAID 5	no	span, stripe, RAID 5	no			span		
3 Drive	span	span, stripe, RAID 5	no	span, Stripe, RAID 5	yes					span, stripe, mirror	span	
3 Drive	stripe	span, stripe, RAID 5	no	span, Stripe, RAID 5	no					span, stripe, mirror	span	
3 Drive	RAID 5	span, stripe, RAID 5	no	span, Stripe, RAID 5	no					span, stripe, mirror	span	
4 Drive	span	span, Stripe, RAID5	no							span, stripe, RAID 5	span, stripe, mirror	span
4 Drive	stripe	span, Stripe, RAID5	no							span, stripe, RAID 5	span, stripe, mirror	span
4 Drive	RAID 5	span, Stripe, RAID5	no							span, stripe, RAID 5	span, stripe, mirror	span
4 Drive	two mirrors (each separate volume would have these options just as with a two-drive mirror)	span, Stripe, mirror	no							span		

Manage RAID

Configure RAID on the hard drives using the **Manage RAID** tab on the Volume Management submenu.



.....
WARNING! Changing the RAID configuration causes all volumes and data to be lost.

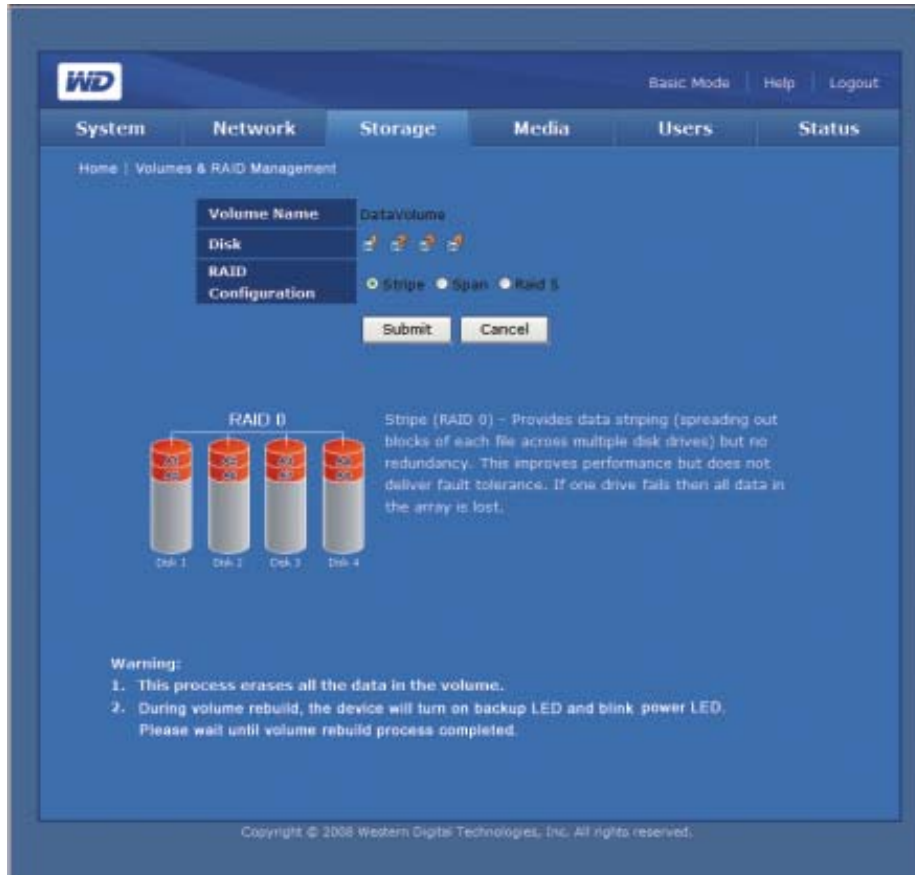

RAID (Redundant Array of Independent Drives) refers to an array of multiple independent hard drives that provide high performance and reliability. RAID function depends on the number of drives present and the RAID level selected.

The WD ShareSpace supports the following RAID levels:

- **RAID 0 (Striped)** - Provides data striping (spreading out blocks of each file across multiple hard drives) but no redundancy. This improves performance but does not deliver fault tolerance. If one drive fails then all data in the array is lost.
- **RAID 1 (Mirrored)** - Provides disk mirroring. Mirroring creates an exact copy (or mirror) of a set of data on two drives, which increases reliability compared to a single drive. If either drive fails, the other continues to function as a single drive until the failed drive is replaced. Note this RAID type has the highest disk overhead (100%) of all RAID types. This option is only available with two drives installed.
- **Two Mirror** - Two Mirror mode is available when four drives are installed in the WD ShareSpace. In this mode, two independent RAID 1 volumes are created.

- **Span (Spanned)** - Combines drives into a linear fashion to create one large logical volume. Unlike RAID 0, which “stripes” all data bitwise to all drives, the volume is linear across both drives. A spanned drive is literally like a single bigger drive, in that files written to the volume earlier go to the “beginning” of the volume, on the first physical drive. As the volume fills, files written later are written toward the “end” of the volume, on the second drive. Like RAID 0, no data redundancy is provided. If one of the drives fails, all data is lost.
- **RAID 5** - Requires a minimum of 3 drives to implement. Similar to RAID 0 but adds fault tolerance by including parity information with the data. Parity is generated on Writes, recorded in a distributed location, and checked on Read. In this mode, failure of a single drive does not cause loss of data.

To configure the Manage RAID tab:



.....

Note: Be sure to back up all data before configuring RAID. All data stored in the hard drive is lost when changing the RAID configuration.

1. Click the **Manage RAID** tab.

2. Select a RAID configuration

DataVolume is the default volume.

3. Click **Submit**.

WD Basic Mode Help Logout

System Network Storage Media Users Status

Home | Volumes & RAID Management

Manage Volume Manage RAID

Volume Name DataVolume

Disk

RAID Configuration Stripe Two Mirror Span Raid 5

Submit Cancel

RAID 5

RAID 5 – Requires a minimum of three drives to implement. Adds fault tolerance by including parity information with the data. Parity for blocks in the same rank is generated on Writes, recorded in a distributed location, and checked on Read.

Warning:

1. This process erases all the data in the device.
2. Folder share is not accessible during volume rebuild.
3. During volume rebuild, the device will turn on backup LED and blink power LED. Please wait until volume rebuild process completed.

Manage RAID Options

Any existing mode can be changed to any other available mode using the Manage RAID option. The following table provides the available modes and data availability for a WD ShareSpace when adding one or more drives.

Starting Configuration	+ 0 Drives	+ 1 Drive	+ 2 Drives	+ 3 Drives	- 1 drive	- 2 drives	- 3 drives
1 Drive	span	span, stripe, mirror	span, stripe, mirror, RAID 5	span, stripe, RAID5, 2 mirrors	x	x	x
2 Drive	span, stripe, mirror	span, stripe, mirror, RAID 5	span, stripe, RAID 5, 2 mirrors	x	span	x	x
3 Drive	span, stripe, mirror, RAID 5	span, stripe, RAID 5, 2 mirrors	x	x	span, stripe, mirror	span	x
4 Drive	span, stripe, RAID 5, 2 mirrors	x	x	x	span, stripe, mirror, RAID 5	span, stripe, mirror	span

Folder Shares

Shares are folders that can be used to organize and store files on your WD ShareSpace. They can be shared with everyone (public) or with selected users on your network (private).

The device comes preconfigured with three shares:

- **Public**—created automatically after initial setup
 - Shared Music - folder for storing music files you want to share with other users.
 - Shared Pictures - folder for storing image files you want to share with other users.
 - Shared Videos - for storing video files you want to share with other users.



.....

Important: Do not change or delete these default share folders. Disruption of file sharing could result. These are the default folders for the Media Server (Twonky Media) and iTunes Service. For more information on how to use Twonky media, see “Media Server” on page 125. For more information on how to use the iTunes service, see “iTunes” on page 126.

- **Download**—for saving files using Downloader (see “Scheduled Downloads” on page 141).
- **Configuration**—this is a read-only share containing only a Help file and the login page. It is not meant for sharing or storing data and should not be modified.

The administrator can create private shares accessible only by user name and password when setting up a user account (see “To create a new user account:” on page 82), or by setting permissions on an existing share (see “Folder Share Permissions” on page 131).

The Folder Shares menu provides access to a list of available shares.

Share	Volume	CIFS	FTP	NFS
cocoaxl	DataVolume	✓	✓	✗
Download	DataVolume	✓	✓	✓
jkb242	DataVolume	✓	✓	✗
* Public	DataVolume	✓	✓	✓
WDShare	DataVolume	✓	✓	✓

Note:

- ✗ indicates that this is a USB autobackup share.
- 📁 indicates that this is a source share for System to USB backup.
- CIFS (Common Internet File System) Access - Allows access to share files via the CIFS protocol. The access control for CIFS is set as share folder-based. This means that a user must enter a valid account and password for accessing the share, and users can only access the shares to which they have been granted access rights (Read Only or Full Access). CIFS is the recommended file sharing protocol for Windows platform, and allows users to access shares through My Network Places. Mac OS X or later also supports the CIFS protocol support.
- FTP (File Transfer Protocol) Access - Allows access to share files via the FTP protocol. Access control rights for the FTP protocol are the same as the CIFS protocol for each share folder. The FTP protocol is a platform-independent file sharing protocol, so the user can use any FTP client program to access shares.
- NFS (Network File System) Access - Allows access to share files via the NFS protocol. NFS protocol access is controlled by a set of accepted IP addresses for each share folder. NFS is recommended for users of UNIX and similar systems.

USB share naming corresponds to the following configuration:
usb-<port number>share<partition number>

To create a share:

1. Click the Add icon .
2. Enter a share name in the **Share** field. The share name can contain up to 32 characters, including alphabetic, numeric, or underscore.
3. Enter a brief description in the **Description** field.
4. Click a file sharing protocol next to **Services**. The WD ShareSpace supports the following file sharing services (protocols):
 - **CIFS (Common Internet File System)** - Allows access to share files via the CIFS protocol. The access control for CIFS is set as share-based. This means that a user must enter a valid account and password for accessing the share, and users can only access the shares to which they have been granted access rights (Read Only or Full Access). CIFS is the recommended file sharing protocol for Windows platform, and allows users to access shares through My Network Places. Mac OS X or later also supports the CIFS protocol.
 - **File Transfer Protocol (FTP)** is a network protocol used to transfer data from one computer to another through a network, such as the Internet, using an FTP client program. FTP is a popular choice for exchanging files independent of the operating systems involved.
 - **Network File System (NFS)** is a network file system protocol that allows a user on a client computer to access files over a network as easily as if the network devices were attached to its local disks.



.....
Note: For FTP and NFS, enable manually on the Advanced Mode Network Services page.

5. Select a logical volume you want to share from the **Volume** list.
6. Click **Setup access control after creating this share** to set access control for the new share. For more information, see “To edit the access rights of users or groups:” on page 132.
7. Click **Submit**.

To modify properties of the share:



.....
Note: Properties for the Public and Download shares cannot be modified, and these shares cannot be deleted.

1. Select the share you want to modify, and then click the Modify icon .
2. Enter a new share name. The share name can contain up to 32 characters, including alphabetic, numeric, or underscores.
3. Enter a brief description.
4. Select a file sharing protocol.
5. Click **Submit**.

To delete existing shares:

1. Select the share to delete.
2. Click the Delete icon .
3. Click **OK**.

USB Shares

The USB Shares icon provides three tabs—**USB Disk**, **USB to WD ShareSpace Backup**, and **WD ShareSpace to USB Backup**. Use these tabs to format a USB drive, remove a USB drive, and perform backup operations from a USB drive to the WD ShareSpace and vice-versa. When a USB storage device with the FAT, FAT32, or NTFS file system is connected to the network storage device, the USB device will be displayed as USB share.

USB Disk

Use the **USB Disk** tab to format or safely disconnect a USB drive or to configure auto backup. (See “USB Auto Backup Feature” on page 60.)

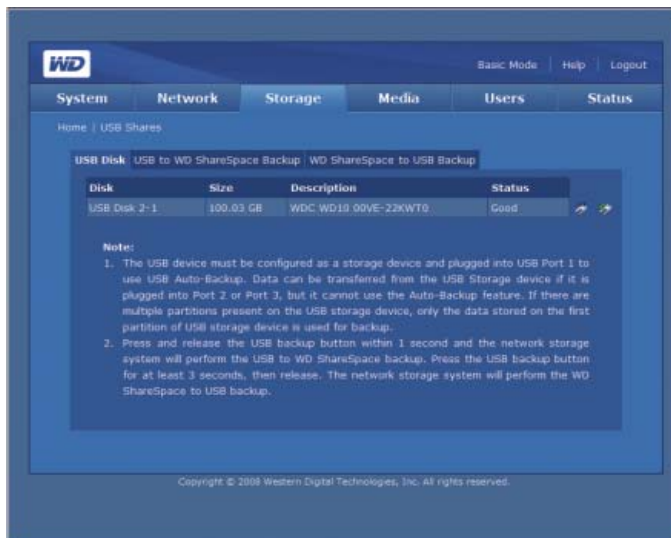

To format a USB drive:

1. Connect a USB drive to the device.



.....
Note: The WD ShareSpace supports USB flash disk and external USB drives; USB optical drives (CD/DVD combo or DVD dual/multi drive) are not supported.

2. On the USB Management page, click the **USB Disk** tab.
3. Select the USB disk to format, and then click the Format icon . A dialog box warns that all data will be erased.

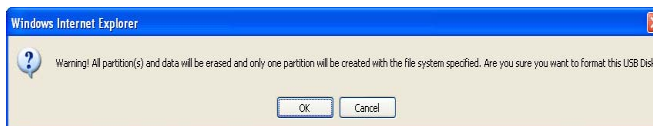

.....
Warning! Formatting hard drives erases all the disk contents, including partition tables, logical volumes, and all shared folders, subfolders, and files. Perform this procedure only when it is safe to proceed. When formatting a USB drive, only one partition is created, and the partition is formatted as FAT32.

4. Click **OK**. The USB LED will blink while the drive is being formatted.
5. Once the LED stops blinking, remove the USB drive from the WD ShareSpace.

To safely remove a USB drive:



.....
Note: Whenever a USB device is disconnected without first being ejected or dismantled, there is a risk of data loss or damage to the USB drive. With the safe remove disk option you can safely remove any USB drive attached to the device.

1. On the **USB Disk** tab, select a USB disk.
2. Click the Safely Remove Disk icon .

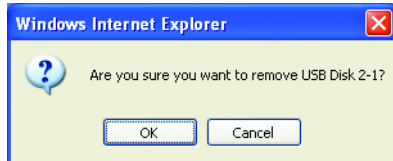

3. Click **OK**.

USB to WD ShareSpace Backup

Use the **USB to ShareSpace Backup** tab to set a destination share for a different USB drive backup.

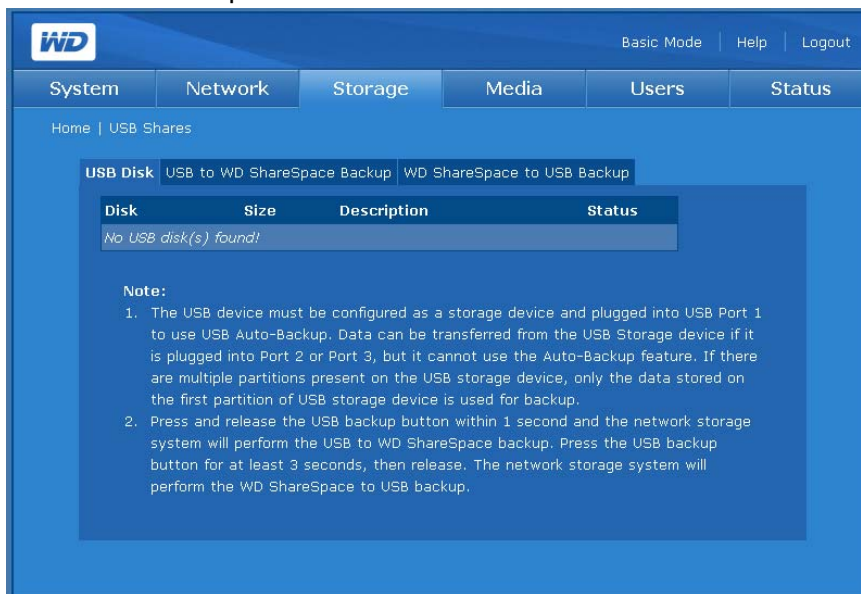

To set a destination share name for the USB drive to WD ShareSpace backup:

1. On the USB Shares page, select the **USB to WD ShareSpace Backup** tab.
2. Select a share to be used as a destination share from the **Destination Share** list.
3. Click **Submit**.



.....
Note: If no destination is selected, backup to the WD ShareSpace is disabled.

WD ShareSpace to USB Backup

Use the **WD ShareSpace to USB Backup** tab to set a source share for this backup method.



To set a source share name for WD ShareSpace to USB drive backup:

1. On the USB Shares page, select the **WD ShareSpace to USB Backup** tab.
2. Select a share to be used as source share from the Source Share list.
3. Click **Submit**.



.....
Note: If no source is selected, backup from the WD ShareSpace is disabled.

Quota

The Quota icon allows administrators to enable or disable quota control for the device and set grace time and quota limits for each user.

Quota is used to limit the maximum storage capacity for each user. The accumulated files or folders stored in a volume for the specified user cannot exceed the quota setting. Once the user data exceeds the quota, a 7-day (by default) grace period commences. The user still can store up to 100 MB of additional data on the volume within the grace period. When the grace period expires, the user cannot store additional data on the volume until deleting the amount of data required to reduce the total capacity used to below quota setting.

Manage Quota

The **Manage Quota** tab in the Quota Management menu provides the quota information for each volume and allows administrators to modify the quota settings.



Note: Use the **Manage Quota tab** to enable quota globally, and use the **DataVolume User Quota** tab to enable quota per person.

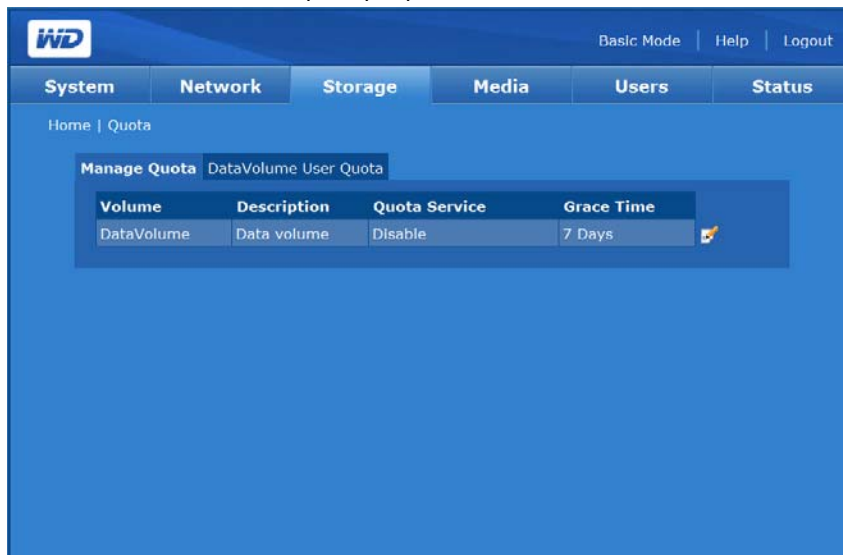

To configure disk quota:

1. Select the volume you want to modify, and then click the Modify icon .
2. Click **Enable** next to **Quota Service** to enable disk quota service.
3. Specify the grace period after which no additional drive space is provided.
4. Click **Submit**.

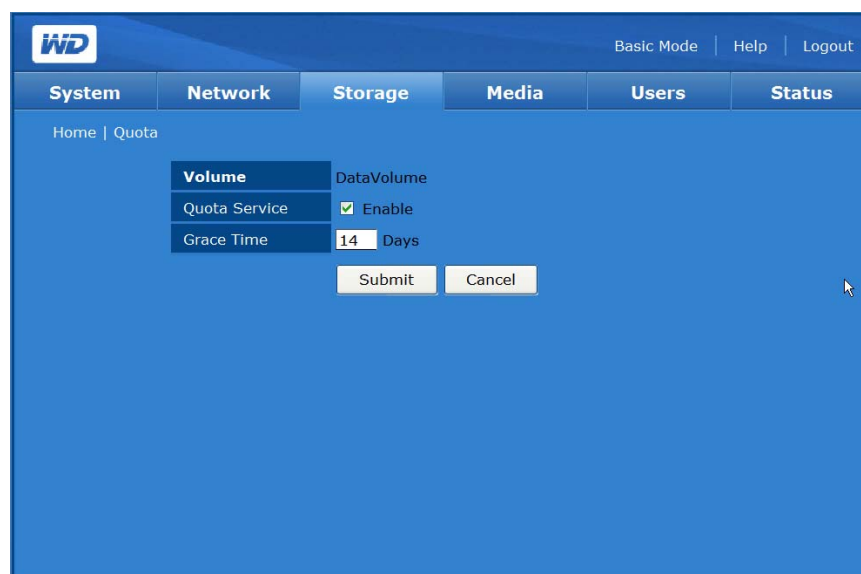

DataVolume User Quota (or ExtendVolume User Quota)

The DataVolume **User Quota** (ExtendVolume User Quota) tab provides user quota information details and allows administrators to modify the user quota setting if two or more volumes are available.

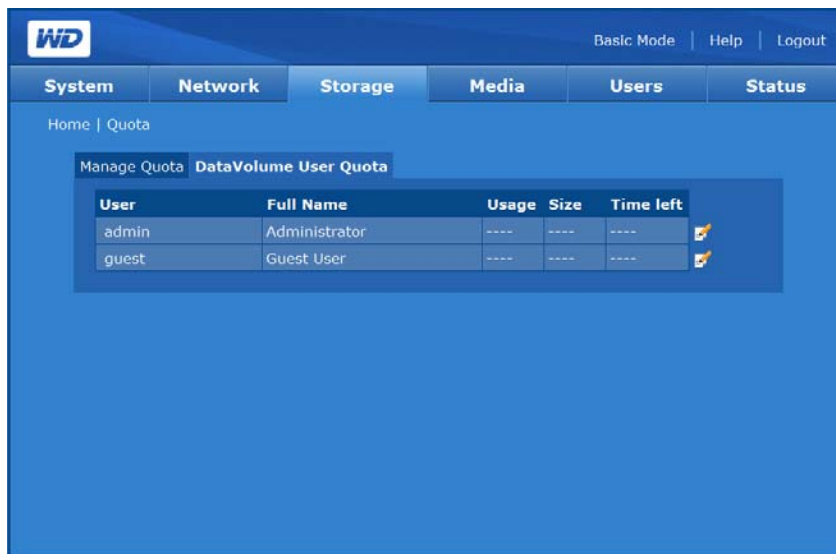
**To modify the user quota setting:**

1. Select the volume you want to modify, and then click the Modify icon.
2. Click **Enable** next to Quota Service to enable disk quota service.
3. Specify the amount of time the saved or backup files will be retained in the system.
4. Click **Submit**.

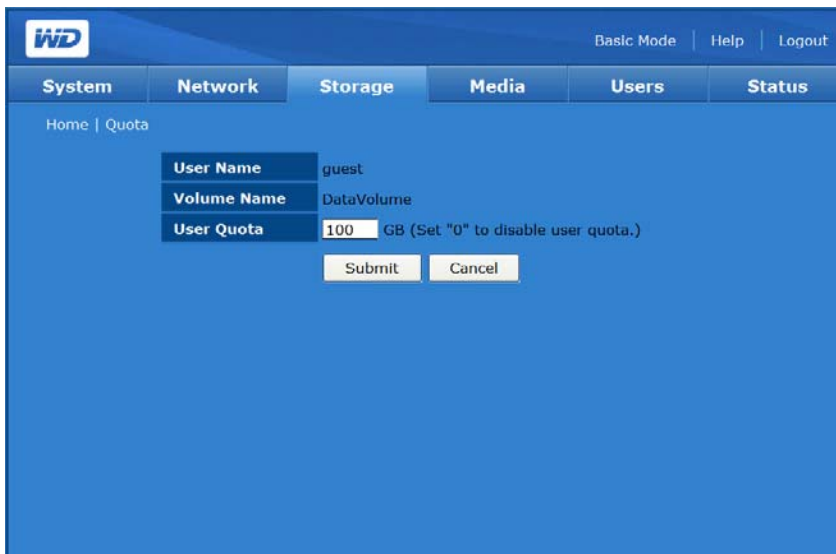

Downloads

The Downloads icon provides two tabs—**Setup Destination Share** and **Change Password**. This menu provides configuration options for selecting the Downloads target share and changing the Downloader login password. This login provides non-administrator users with a method to download files directly to the WD ShareSpace.

Set up Destination Share

Use the **Setup Destination Share** tab to choose the target share for the Downloader utility. For more information on how to use the Downloader utility, refer to “Scheduled Downloads” on page 141.

To set the destination share name for the Downloader:

1. On the Downloads page, click the **Setup Destination Share** tab.
2. Select the folder to share with others from the **Destination Share** list.
3. Click **Submit**.

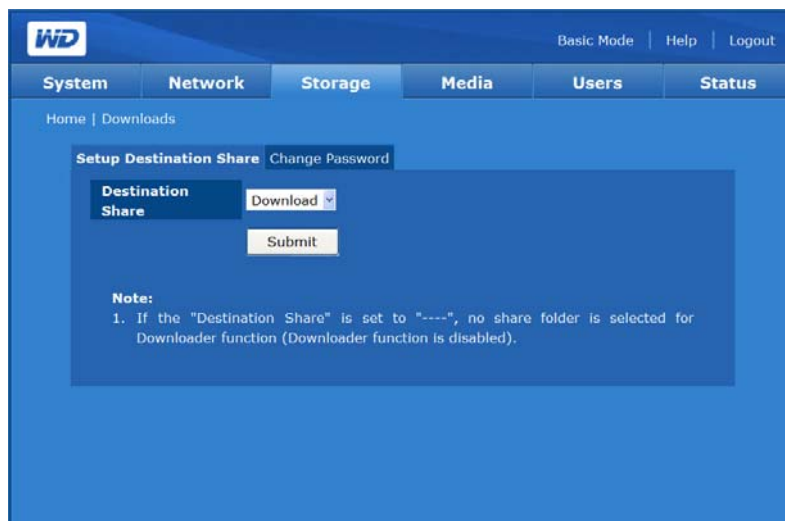

.....

Note: If no destination is selected, the download utility is disabled. For instructions on using the download utility, see “Downloader Features” on page 142.

Change Password

The **Change Password** tab allows you to change the Downloader’s password.

To change the Downloader’s password:



.....

Note: The default password is “downloader.” The user name is always “downloader.”

1. On the Downloads page, click the **Change Password** tab.
2. Enter a password in the **Change Password** field. The maximum length of the password is 16, including alphabetic, numeric, underscore, space, and most special characters except double-quote ("). The first and last characters cannot be a space. The password is case sensitive.
3. Re-enter the password in the **Confirm Password** field.

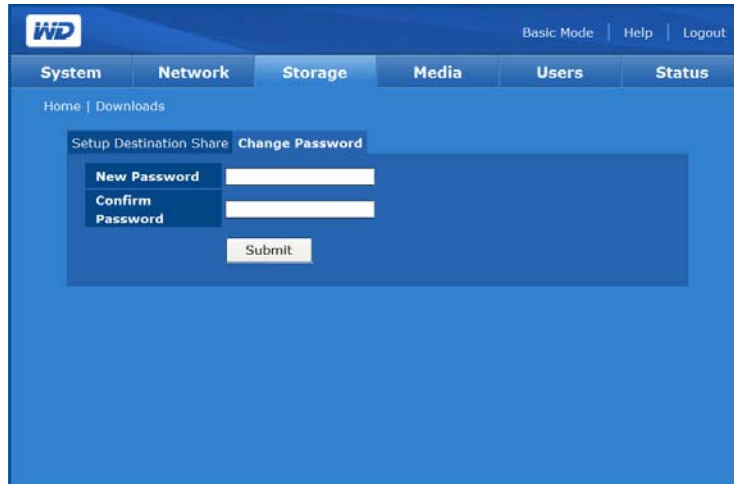
4. Click **Submit**.

Media Tab

The **Media** tab provides access to the Media Server and iTunes icons.

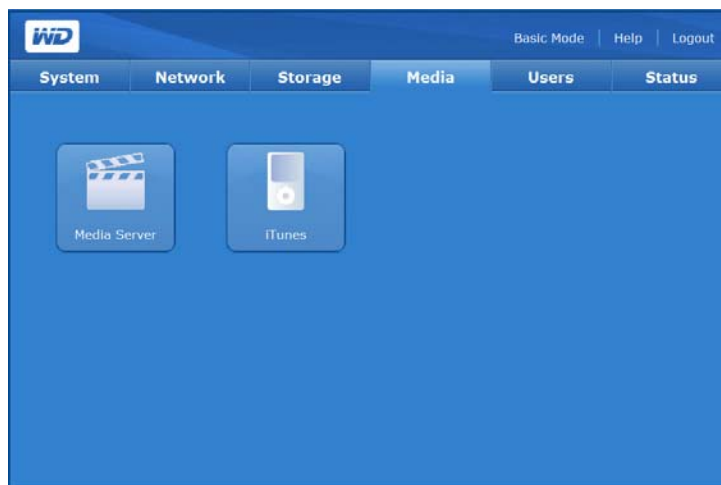

.....

Note: The Media Server and iTunes servers only work on the LAN.

Media Server



.....

Note: It is not mandatory to access the Twonky Media server to search for or play media files as long as the file is in its respective media folder (videos, photos, or music).

The Twonky Media server application searches for the media in the three shared folders (Videos, Photos, and Music) stored on the WD ShareSpace connected to your home network. The server is pre-set, so you can just transfer your multimedia content to the respective shared folders on your WD ShareSpace (described on the next page), and you are ready to stream and view content on your home entertainment center, game consoles (for example, Xbox 360, Playstation 3, or DLNA 1.5 Digital Media Adapters). Visit www.twonkymedia.com for further information on Twonky Media.

iTunes

Enable the iTunes Server Service and customize the service settings using the **iTunes** menu. iTunes Server Service allows iPod and iTunes users to share and play music on the WD ShareSpace.



.....
Note: iTunes service is enabled by default.

When the iTunes Service is enabled in the WD ShareSpace's Network Storage Manager, you or anyone connected to the WD ShareSpace can play music files stored on the system using iTunes. This service creates a virtual music library on the device and treats it as an iTunes repository, making it possible for music files to stream from the WD ShareSpace to Windows or Mac computers running iTunes.

The iTunes Server Service supports only the following file types:

- *.mp3
- *.wav
- *.aac



.....
Note: The iTunes server service requires the presence of the /Public/Shared Music share folder. Do not rename or delete Shared Music if you want to use the iTunes server. You must recreate or rename the /Public/Shared Music share if it has been deleted or given another name.

To enable or disable the iTunes Server Service:

1. On the iTunes Server Service page, click **Enable** next to iTunes Service. Or, deselect the option to disable it.
2. Specify how often iTunes will scan the device for new music files.
3. Click **Submit**.

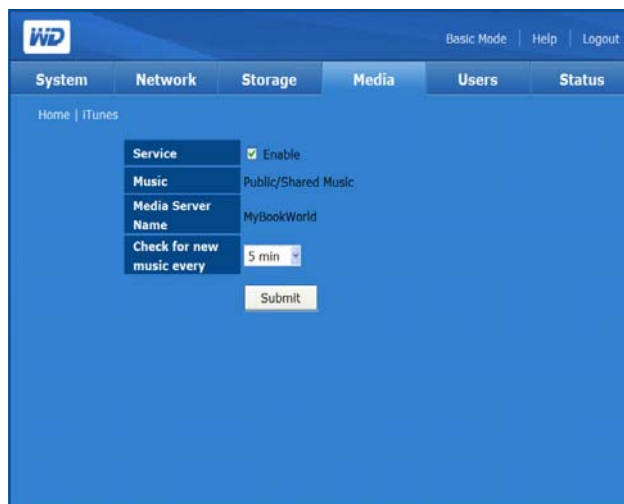

To customize media library update frequency:

1. Select an option in the **Check for new music every** list.
2. Click **Submit**.

To stream audio in iTunes:

1. Make sure that the iTunes Service is enabled in the WD ShareSpace's Network Storage Manager utility. See "To enable or disable the iTunes Server Service:" on page 126 for more information.
2. Click **WDSHareSpace** under the Shared section of the left pane. If you have copied music to the /Public/Shared Music folder and it is in a format supported by iTunes, it should be listed in the right pane.
3. Double-click an audio file.

The audio file is streamed in iTunes and audio files from the WD ShareSpace are displayed under the Shared list.

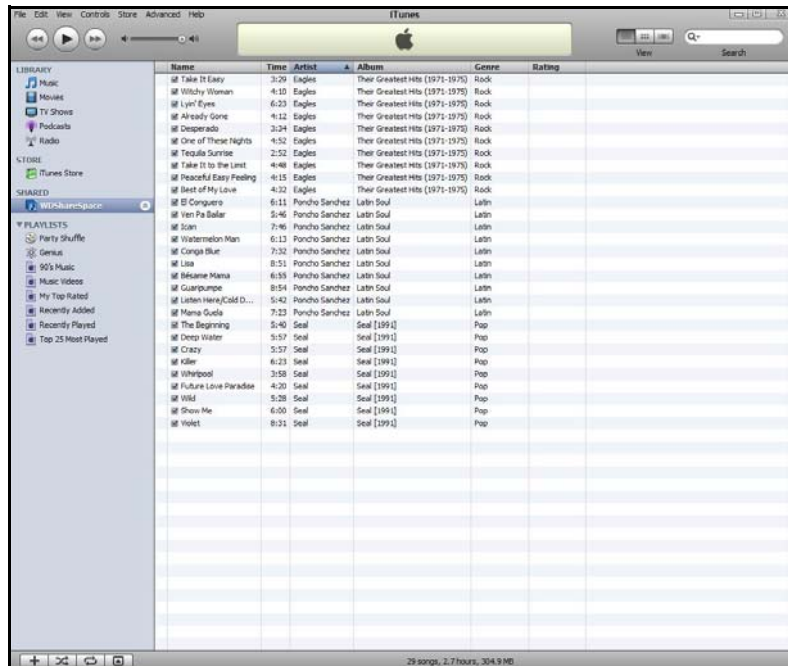

Note: Both the Media Server and the iTunes server only work on the LAN.

Users Tab

The **Users** tab provides access to the following configuration options:

- Users
- Groups
- Folder Share Permissions
- USB Share Permissions



Users

The Users icon on the **Users** tab allows administrators to create, edit, and delete user accounts from Access Control list management.

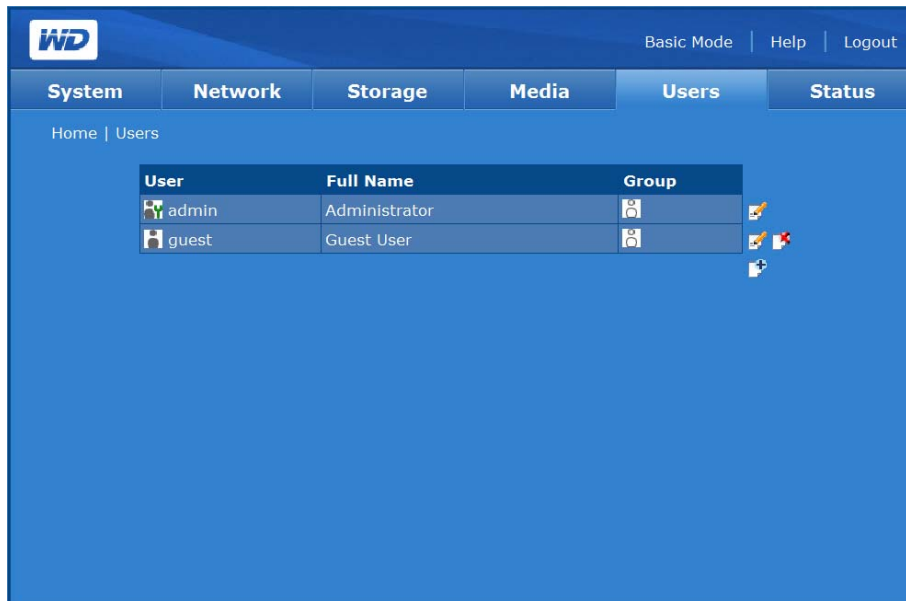

To create a new user account:

With this feature, you can create user accounts on the WD ShareSpace and further customize these accounts with privilege levels.

1. Click the Add icon .



.....

Note: The password can contain up to 16 characters, including alphabetic, numeric, underscore, space, and most special characters except double-quote (""). The first and last characters cannot be a space. The password is case sensitive.

2. Click **Grant Administration Rights** to provide the user with administrative rights. Administration rights allow the user to configure the device.
3. Enter the user name in the **User Name** field.
4. Enter the user's full name in the **Full Name** field.
5. Enter the password in the **Password** field.
6. Re-enter the password in the **Confirm Password** field.
7. If desired, select a previously created Group for the user to join from the **Group List**.
8. Click the **>>** button to add the selected user to the group.
9. You may create a private user share at the same time by clicking **Yes** next to **Create User Private Share**. The new user is granted Full Access to the private share. The private share name is the same as the user name. Nobody else has access to this private share unless it is specifically granted by the administrator.
10. Select a volume that you want the user to access.
11. Select one or more file sharing protocols to access private shares.
12. Click **Submit**.

The screenshot shows the 'Users' management page in the WD ShareSpace interface. The page has a blue header with the WD logo and navigation links for 'Basic Mode', 'Help', and 'Logout'. Below the header is a navigation bar with tabs for 'System', 'Network', 'Storage', 'Media', 'Users', and 'Status'. The 'Users' tab is selected, and the page content is titled 'Home | Users'. The main form contains the following fields and options:

- User Name:** A text input field containing 'test'.
- Admin Rights:** A checkbox labeled 'Grant Administration Rights' which is checked.
- Full Name:** A text input field containing 'Test'.
- Password:** A text input field with masked characters (dots).
- Confirm Password:** A text input field with masked characters (dots).
- Group List:** An empty list box on the left.
- Group Joined:** An empty list box on the right.
- Group Member:** A label positioned between the two group list boxes.
- Navigation:** '>>' and '<<' buttons between the group list boxes.
- Create User Private Share:** Radio buttons for 'Yes' (selected) and 'No'.
- Volume:** A dropdown menu currently showing 'DataVolume'.
- Services:** Checkboxes for 'CIFS' (checked), 'FTP' (checked), 'NFS' (unchecked), and 'AFP' (checked).
- Buttons:** 'Submit' and 'Cancel' buttons at the bottom of the form.

To modify a user account:

1. Select the user account to modify, and then click the Modify icon .
2. Make the desired changes, and then click **Submit**.

To delete an existing user account:

1. Click the Delete icon  next to the user account you want to delete.
2. Click **OK**.

Groups

The **Groups** icon on the **Users** tab allows the administrator to create, edit, and delete a group from Access Control list management.

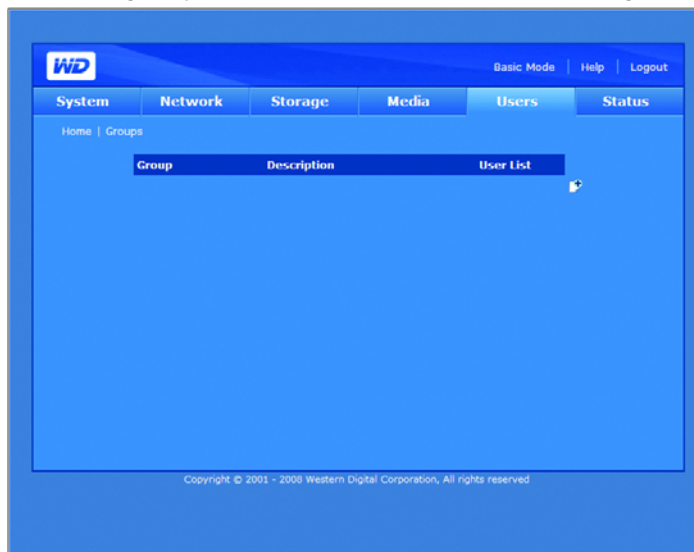
**To create a group:**

1. Click the Add icon .
2. Assign a new group name.
3. Enter a description of the new group.
4. Select users from the **User List** field to add to the **User Joined** field.
5. Click the **>>** button.

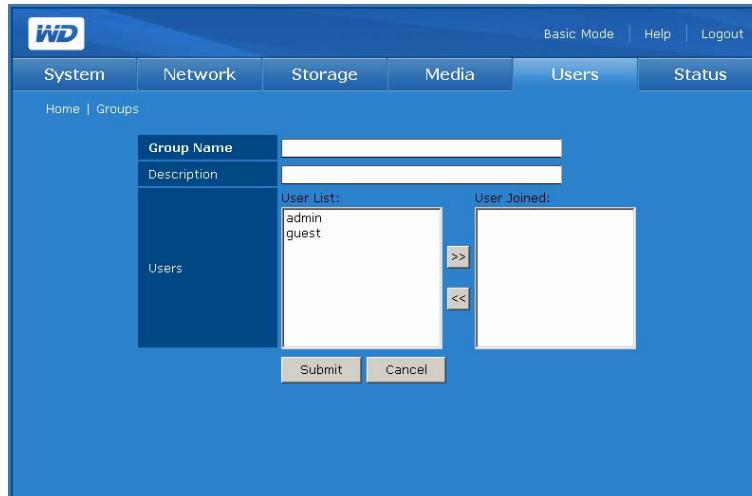
6. Click **Submit**.**To modify a group:**



1. Select the group you want to modify, and then click the Modify icon .
2. Make the desired changes, and then click **Submit**.

To delete a group:

1. Select the group you want to delete, and then click the Delete icon .
2. Click **OK**.

Folder Share Permissions

The Folder Shares menu allows you to set the access control for each user or group in the Access list.

- Public Access 
- Full Access 
- Read Only 
- Deny Access 
- Not Assigned 

When there is a conflict in the access rights of the user and group, the WD ShareSpace uses the following rules to handle the conflict:

- Deny Access will have the highest priority.
- Full Access + Read Only = Full Access.

If the access control is assigned to users or groups, the full access, read only, and no access icons appear on the Share Access page. You can move your mouse over the icon to view the user or group list.

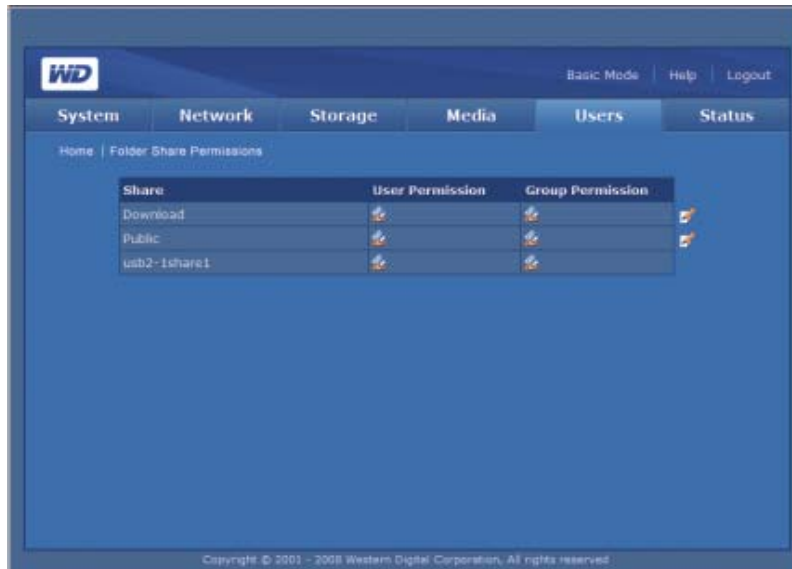

To edit the access rights of users or groups:

1. Select a user or group, and then click the Edit icon
2. Click **Enable** next to Public Access to allow everyone to access to the share.
3. Select an access option.
4. In the **Not Assigned Users** list, select the users to whom you want to grant full access, read only permission, or no access to the share.
5. Click the >> button.
6. In the **Not Assigned Groups** list, select the local groups to which you want to grant full access, read only permission, or no access to the share.
7. Click the >> button.

8. Click **Submit**.

The screenshot shows the 'Folder Share Permissions' configuration page in the WD Sharespace web interface. The page is titled 'Home | Folder Share Permissions' and has a navigation bar with 'System', 'Network', 'Storage', 'Media', 'Users', and 'Status' tabs. The 'Users' tab is selected.

Share Information:

Name	cocoaxl
Description	the private share of cocoaxl
Volume	DataVolume
Services	✓ CIFS ✓ FTP ✗ NFS

Public Access: Enable

Users Access:

Unassigned Users: admin, guest, jkb242

Full Access: cocoaxl

Read Only:

No Access:

Groups Access:

Unassigned Groups:

Full Access:

Read Only:

No Access:

Buttons: Submit, Cancel



Note: Public shares can be accessed using the administrator name and password as well as a guest name and password. The guest name and password are both "guest."

USB Share Permissions

The USB Shares icon on the **Users** tab allows you to set access control for the two USB ports on the back of the device.

The types of access control that you can assign to a user or group include:

- Public Access 
- Full Access 
- Read Only 
- Deny Access 
- Not Assigned 

When there is a conflict in the access rights of the user and group, the device uses the following rules to handle the conflict:

- Deny Access will have the highest priority.
- Full Access + Read Only = Full Access.

If access control is assigned to users or groups, the full access, read only, and no access icons appear on the Share Access page. You can move your mouse over the icon to view the user or group list.



To edit the access rights of users or groups:

1. Select the share you want to modify by clicking the Edit  icon next to that share.
2. Click **Enable** next to **Public Access** to allow everyone to access the share.
3. Select an access option.
4. In the **Not Assigned Users** list, select the users to whom you want to grant full access, read only permission, or no access to the share.
5. Click the >> button.

6. In the **Not Assigned Groups** list, select the local groups to which you want to grant full access, read only permission, or no access to the share.
7. Click the >> button.
8. Click **Submit**.

The screenshot displays the 'Users' configuration page for a USB share. The 'Share Information' section shows the share name as 'Public' and the volume as 'DataVolume'. Under 'Public Access', the 'Enable' checkbox is checked. In the 'NFS Access' section, 'Full Access' is selected. The 'Users Access' section is currently empty. The 'Groups Access' section shows a list of 'Unassigned Groups' containing 'Bayou'. To the right of this list are three columns for assigning permissions: 'Full Access', 'Read Only', and 'No Access'. Each column has a '>>' button to move the selected group into that category. At the bottom of the page, there are 'Submit' and 'Cancel' buttons.

Status Tab

The **Status** tab provides access to the following configuration options.

- System Status
- System Logs

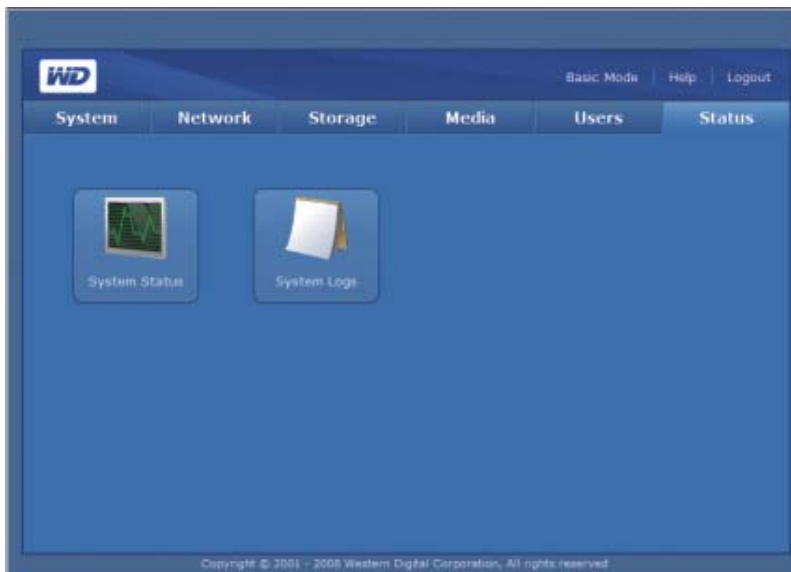

System Status

The System Status icon on the **Status** tab displays general information about the system: device name, version, current date/time, system uptime, IP address, volume usage, and volume RAID type if RAID is functioning properly. If RAID is not healthy, the RAID/Volume Usage field displays “failed.”

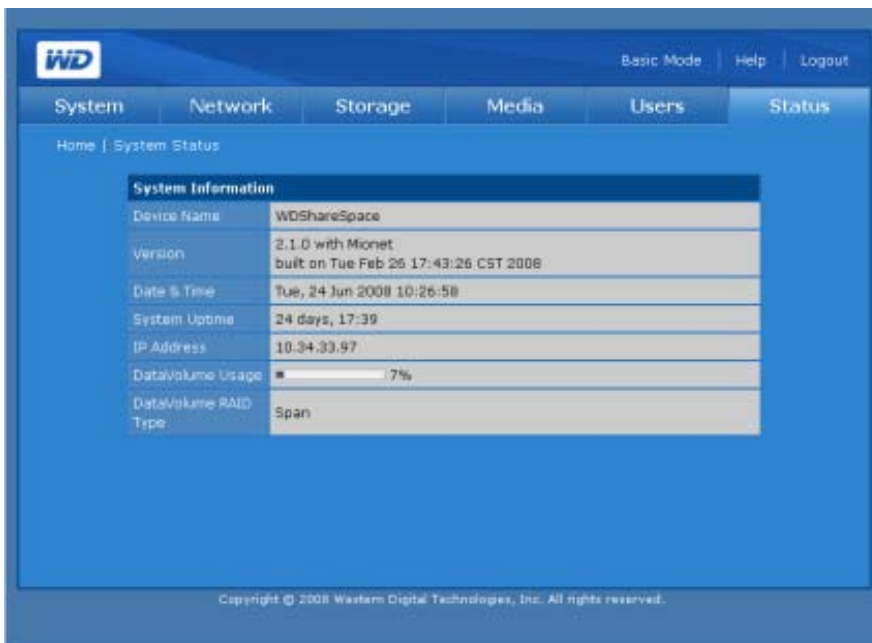

System Logs

The System Logs icon on the **Status** tab provides access to four tabs that display the events recorded by the system. You can view information such as file and services requested on the device, and requests between the device and client computers. You can also change the order and number of the log entries shown on log pages.

System

The **System** tab displays system logs on the device.

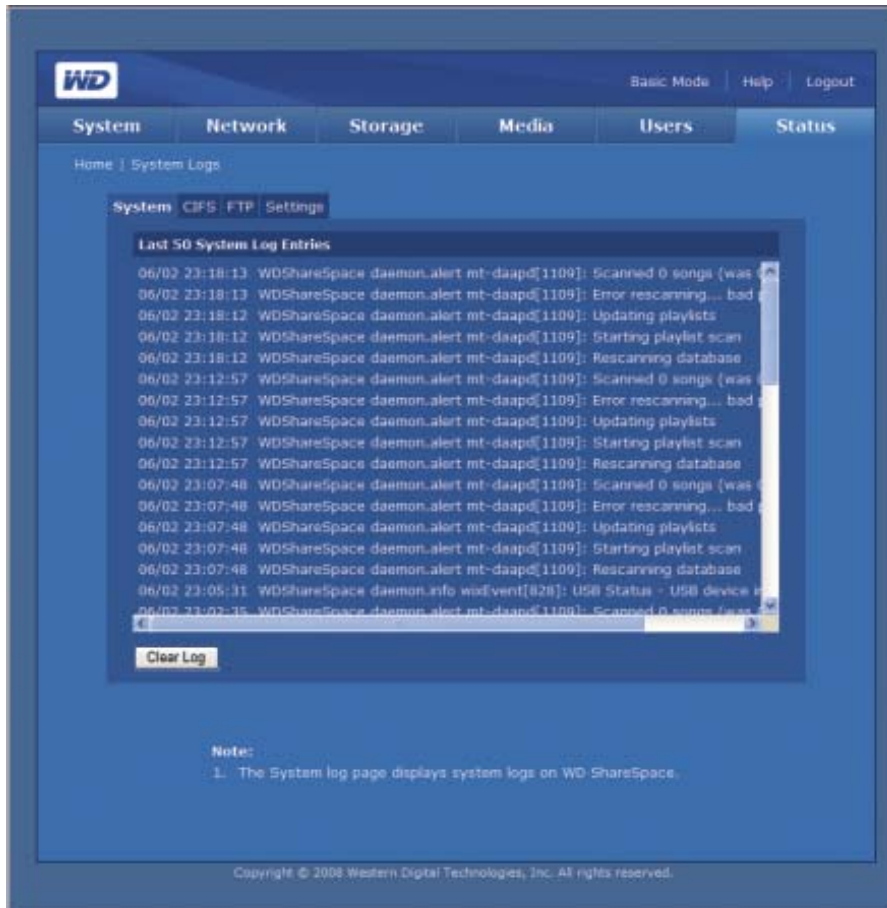

The System Log records events that occur in the system. You can obtain information from the following conditions or errors that may occur in the system components, and hardware or software components.

- System shutdown
- System reboot
- Factory default restore failed
- System temperature warning
- Disk SMART failure
- Volume failed or does not exist
- Volume space is full or close to 100%
- Unsafe removal of a USB mass storage device
- Resync volume failed

The following types of events are logged:

- **Critical**—An event such as fan failed, system temperature has exceeded the threshold level, Disk SMART failed, volume space is full or close to 100%, extend volume failed, or resync volume failed. When a critical event occurs the power/system status LED lights up and the system record events in the System Log.
- **Warning**—An event that is not necessarily significant, but may indicate a possible future problem. An e-mail or pop-up message alert is sent to notify user of the problem that occurred in the system.
- **Information**—An event that describes the successful operation of an application, driver, or service.

CIFS

The **CIFS** (Common Internet File System) tab displays logs of file and services requested on the device for connections that use this protocol.

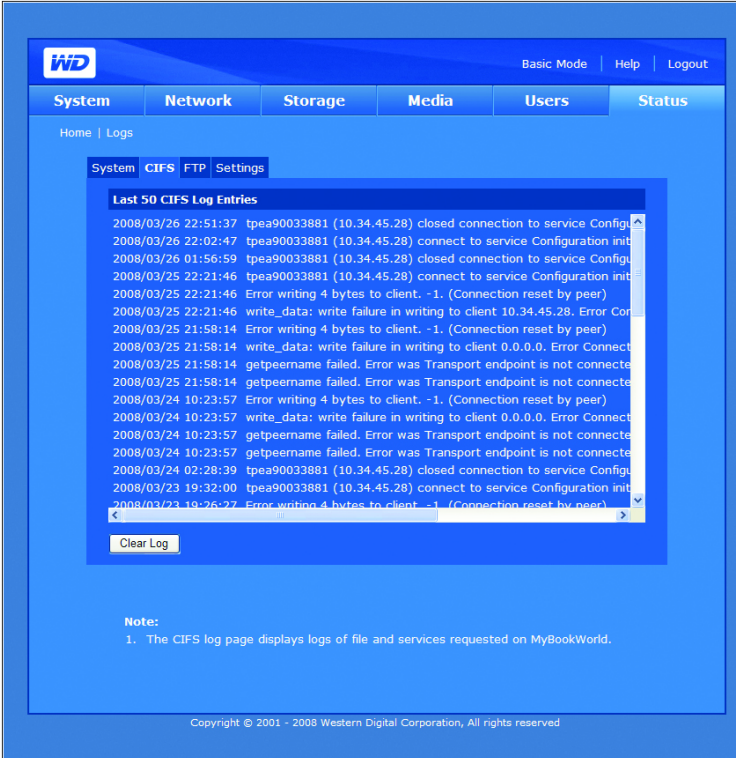

The screenshot shows the WD MyBookWorld web interface. At the top, there is a navigation bar with the WD logo, "Basic Mode", "Help", and "Logout". Below this is a menu with tabs for "System", "Network", "Storage", "Media", "Users", and "Status". The "System" tab is selected, and within it, the "CIFS" sub-tab is active. The main content area displays "Last 50 CIFS Log Entries" with a scrollable list of log entries. Each entry includes a timestamp, a client IP address, and a description of the event. A "Clear Log" button is located at the bottom of the log list. Below the log list, there is a "Note" section with one item: "1. The CIFS log page displays logs of file and services requested on MyBookWorld." At the very bottom of the page, there is a copyright notice: "Copyright © 2001 - 2008 Western Digital Corporation, All rights reserved."

Timestamp	Client IP	Event Description
2008/03/26 22:51:37	tpea90033881 (10.34.45.28)	closed connection to service Configuration init
2008/03/26 22:02:47	tpea90033881 (10.34.45.28)	connect to service Configuration init
2008/03/26 01:56:59	tpea90033881 (10.34.45.28)	closed connection to service Configuration init
2008/03/25 22:21:46	tpea90033881 (10.34.45.28)	connect to service Configuration init
2008/03/25 22:21:46		Error writing 4 bytes to client. -1. (Connection reset by peer)
2008/03/25 22:21:46		write_data: write failure in writing to client 10.34.45.28. Error Connect
2008/03/25 21:58:14		Error writing 4 bytes to client. -1. (Connection reset by peer)
2008/03/25 21:58:14		write_data: write failure in writing to client 0.0.0.0. Error Connect
2008/03/25 21:58:14		getpeername failed. Error was Transport endpoint is not connecte
2008/03/25 21:58:14		getpeername failed. Error was Transport endpoint is not connecte
2008/03/24 10:23:57		Error writing 4 bytes to client. -1. (Connection reset by peer)
2008/03/24 10:23:57		write_data: write failure in writing to client 0.0.0.0. Error Connect
2008/03/24 10:23:57		getpeername failed. Error was Transport endpoint is not connecte
2008/03/24 10:23:57		getpeername failed. Error was Transport endpoint is not connecte
2008/03/24 02:28:39	tpea90033881 (10.34.45.28)	closed connection to service Configur
2008/03/23 19:32:00	tpea90033881 (10.34.45.28)	connect to service Configuration init
2008/03/23 19:26:27		Error writing 4 bytes to client. -1. (Connection reset by peer)

FTP

The **FTP** (File Transfer Protocol) tab displays logs of the requests and records transferred between the device and client computers for connections that use this protocol.

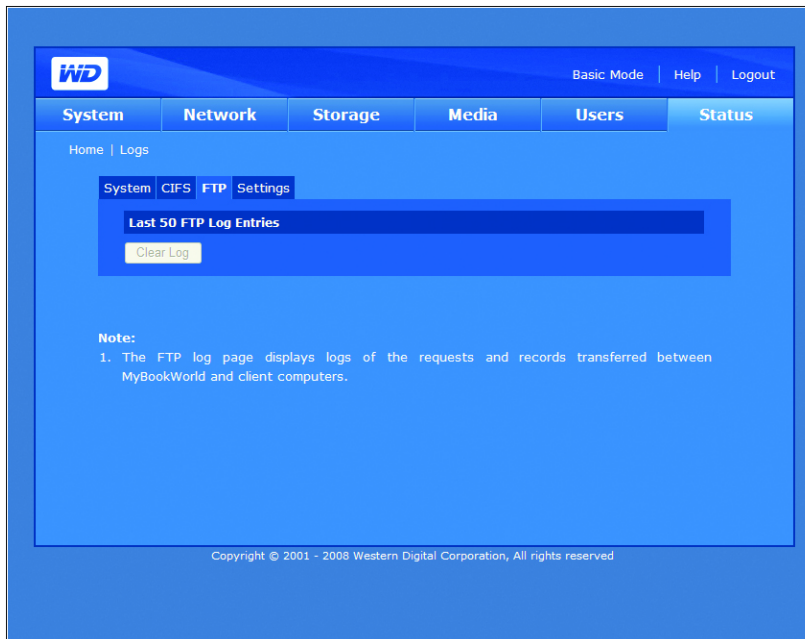

Settings

The **Settings** tab assigns the order and number of log entries that appear on the Logs page.

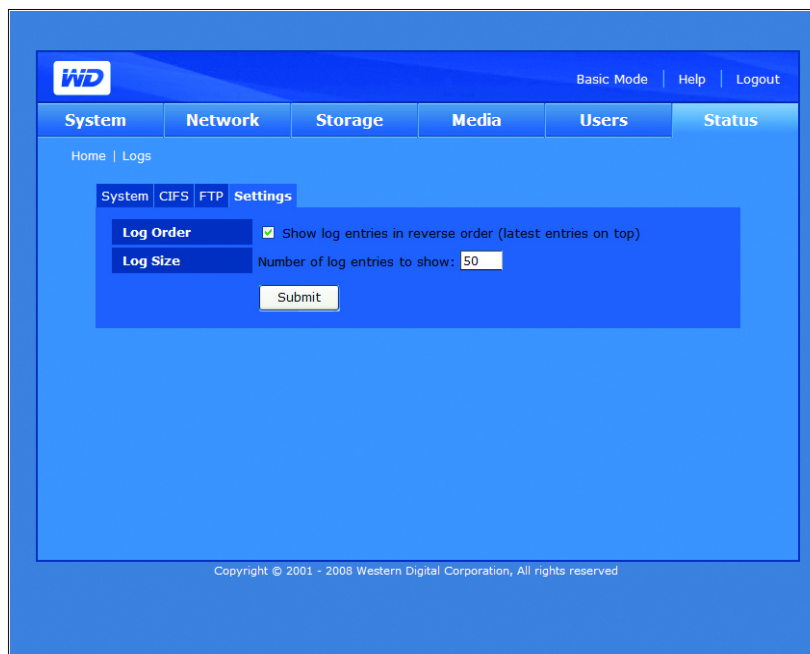

To configure the log settings:

1. On the **Settings** tab, click **Show log entries in reverse order** to display the most recent entries at the top.
2. Enter the number of entries you want to appear on the System, CIFS, and FTP logs.

11

Scheduled Downloads

Downloader is a powerful tool for managing download tasks directly to the unit. This tool is great for when you want to download very large or multiple large files from the Internet and do not want to sit and wait for the download to complete. All you have to do is identify the URL of the files you want to download from the Internet and set it in the Download function on your WDSHareSpace. Then you can walk away and let this tool do the rest. All the files that you want to download are saved directly to your WDSHareSpace and you do not even need to have your computer on. For example, this is the ideal tool for downloading from video file sharing websites.

With a user-friendly interface, the Downloader supports multiple simultaneous downloads with various functions to manage downloads. Use Downloader to download files to a default share folder in the WD ShareSpace and share the files among many users. To use Downloader, you must set a default share folder to Download in the WD ShareSpace's Network Storage Manager utility. For more information, see "To set the destination share name for the Downloader:" on page 124.

Accessing Downloader



Important: To access Downloader, make sure a destination folder is properly configured in the WD ShareSpace's Network Storage Manager utility. If no destination is specified, Downloader is disabled. Refer to "To set the destination share name for the Downloader:" on page 124.

You can access Downloader by entering the system's web-based user interface. See "Accessing WD ShareSpace's Network Storage Manager" on page 74 for instructions.

1. In the **Tool** list, click **Downloader**.
2. Enter "downloader" in both the **Administrator Name** and **Password** fields and click **Login**.



Note: You can change the password, but the administrator name is always "downloader."

Downloader Features

Downloader includes the following features:

- Download faster with instantaneous “start”
- Simultaneous download of multiple files from the Internet
- Files are automatically stored to a user-defined destination folder in WD ShareSpace.
- Automatically store your partially downloaded files in the database to resume downloading at any time
- Set download speed to reduce bandwidth consumption
- Schedule and queue downloads
- Resume downloading a partial download

User Interface Overview

The Downloader user interface includes two tabs — **Tasks** and **Settings**.

Tasks

The **Tasks** tab includes a table that displays the file transfer processes. The status of the file download is displayed using icons located on the File Name column and located immediately below the Submit button provides detailed information about the meaning of each status icon. The command icons located on the right-side of the tasks table allow you to add download entries, stop file download, or delete download task.

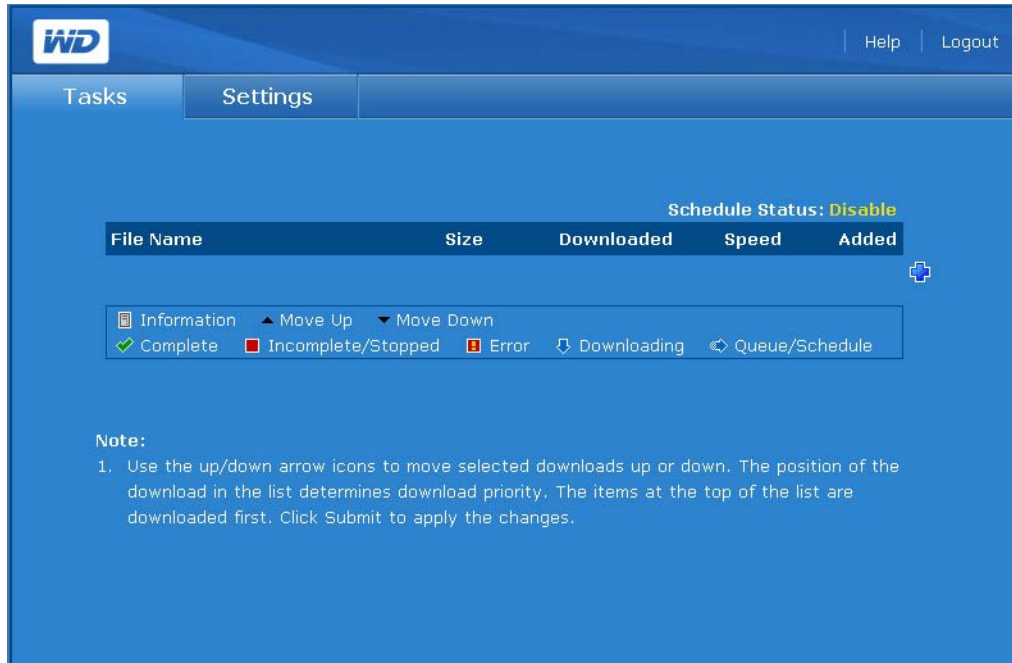





The screenshot shows the WD Downloader user interface. At the top, there is a blue header with the WD logo on the left and 'Help' and 'Logout' links on the right. Below the header are two tabs: 'Tasks' and 'Settings'. The 'Tasks' tab is active. The main content area displays a table with the following columns: 'File Name', 'Size', 'Downloaded', 'Speed', and 'Added'. Above the table, there is a 'Schedule Status: Disable' indicator. Below the table, there is a legend with icons for 'Complete' (green checkmark), 'Incomplete/Stopped' (red square), 'Error' (red square with exclamation mark), 'Downloading' (blue square with white arrow), and 'Queue/Schedule' (blue square with white double arrow). A 'Note' section at the bottom provides instructions on using the up/down arrow icons to move selected downloads up or down.

Note:

1. Use the up/down arrow icons to move selected downloads up or down. The position of the download in the list determines download priority. The items at the top of the list are downloaded first. Click Submit to apply the changes.

Command icons

The **Downloader Tasks** tab includes the following commands:

Icon	Command	Description
	Add	Creates a download task.
	Start	Starts a specific download task.
	Stop	Ends the download task.
	Delete	Deletes download task from the table.
	Help	Displays the online guide.
	Logout	Exits the Downloader utility.

Settings

Set the download speed, create, and schedule several downloads using the **Settings** tab.



Note:

1. The 'Max. Running No.' field shows the maximum number of simultaneous downloads.
2. Limit the download speed to the amount of bytes per second. This amount may be expressed in bytes, kilobytes, or megabytes. This is useful for when you don't want Downloader to consume the entire available bandwidth. This option allows the use of decimal numbers, usually in conjunction with power suffixes (e.g., 2.5 is a legal value).
3. The Downloader implements speed limiting by sleeping after a network read that takes less time than the rate specified. Eventually, the TCP transfer slows down to the approximate value of the specified rate. However, it may take some time for this balance to be achieved. Limiting the rate may not work as successfully with very small files.
4. The download speed applies only to the downloaded tasks which have yet to begin.



Using Downloader

To create a download task:

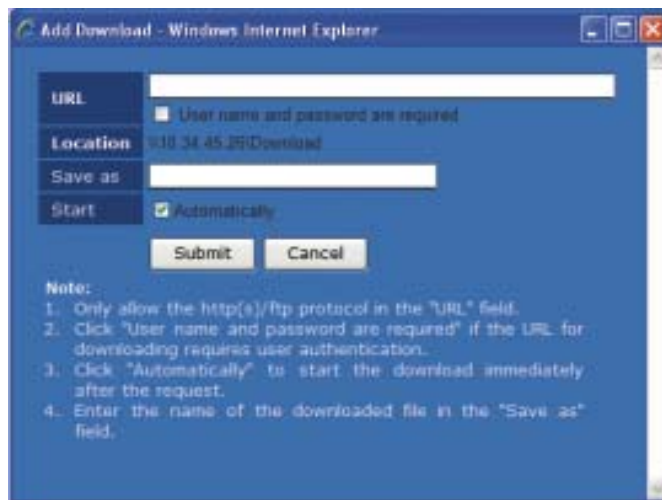
1. On the Tasks page, click Add .
2. Enter the full web address from which you want to download the file in the URL field.
3. If a user name and password is required to download the file, click **User name and password are required**, and then enter the user name and password.
4. If you want to enter a new name for the file, enter a new name in the **Save As** field.
5. Click **Automatically** to start downloading immediately after the request.
6. Click **Submit**.



To stop and resume a download task:

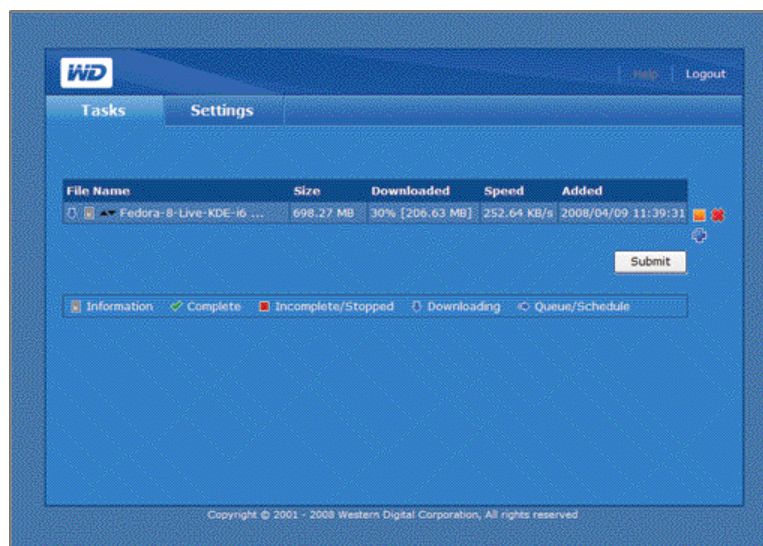

1. Select a task in the Tasks table.
2. Click Stop  to stop the download task.
3. Click Start  to resume download task.



To delete a download task:

1. Select a task in the Tasks table.
2. Click Delete  to delete the download task.
3. Click **OK**, and then click **OK** again.
4. Click **Submit**.

To change the order of the download queue:

1. Use the arrow buttons to change the order of download tasks or to make a task conditional on a previous task.
2. Select a task in the Tasks table, and then click Move Up  or Move Down .
3. Click **Submit**.

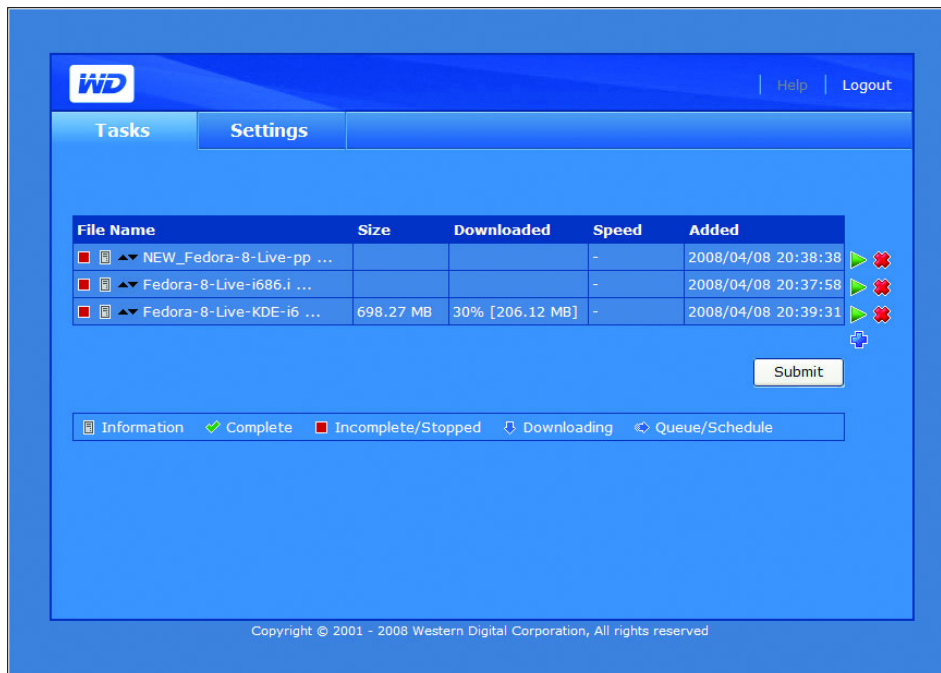
**To customize the Downloader settings:**

1. On the Downloader page, click the **Settings** tab.
2. Select a number to specify the maximum number of simultaneously running downloads in the **Max. Running No.** field.
3. Specify the decimal numbers to limit the downloaded speed if you don't want to consume the entire available bandwidth in Downloader in the **Download Speed** field.
4. Set up the proxy in the **Proxy** field to download files if your network environment doesn't allow making direct connections to an external network.
5. Click **Enable** next to **Schedule** to enable scheduled downloading time.
Periods of time during which downloading is allowed are indicated in yellow.

6. Click **Submit**.

The screenshot shows the 'Settings' tab in the WD Sharespace interface. The 'Schedule' section is active, displaying a grid for configuring download times. The grid has columns for days of the week (Sun-Sat) and rows for time intervals (00:00-03:00, 03:00-06:00, 06:00-09:00, 09:00-12:00, 12:00-15:00, 15:00-18:00, 18:00-21:00, 21:00-00:00). Checkmarks are present in the following cells: (Sun, 00:00-03:00), (Tue, 00:00-03:00), (Thu, 00:00-03:00), (Sat, 00:00-03:00), (Mon, 21:00-00:00), (Wed, 21:00-00:00), and (Fri, 21:00-00:00). Below the grid are 'Submit' and 'Cancel' buttons.

	Sun	Mon	Tue	Wed	Thu	Fri	Sat
00:00 - 03:00	<input checked="" type="checkbox"/>	<input type="checkbox"/>	<input checked="" type="checkbox"/>	<input type="checkbox"/>	<input checked="" type="checkbox"/>	<input type="checkbox"/>	<input checked="" type="checkbox"/>
03:00 - 06:00	<input type="checkbox"/>	<input type="checkbox"/>	<input type="checkbox"/>	<input type="checkbox"/>	<input type="checkbox"/>	<input type="checkbox"/>	<input type="checkbox"/>
06:00 - 09:00	<input type="checkbox"/>	<input type="checkbox"/>	<input type="checkbox"/>	<input type="checkbox"/>	<input type="checkbox"/>	<input type="checkbox"/>	<input type="checkbox"/>
09:00 - 12:00	<input type="checkbox"/>	<input type="checkbox"/>	<input type="checkbox"/>	<input type="checkbox"/>	<input type="checkbox"/>	<input type="checkbox"/>	<input type="checkbox"/>
12:00 - 15:00	<input type="checkbox"/>	<input type="checkbox"/>	<input type="checkbox"/>	<input type="checkbox"/>	<input type="checkbox"/>	<input type="checkbox"/>	<input type="checkbox"/>
15:00 - 18:00	<input type="checkbox"/>	<input type="checkbox"/>	<input type="checkbox"/>	<input type="checkbox"/>	<input type="checkbox"/>	<input type="checkbox"/>	<input type="checkbox"/>
18:00 - 21:00	<input type="checkbox"/>	<input type="checkbox"/>	<input type="checkbox"/>	<input type="checkbox"/>	<input type="checkbox"/>	<input type="checkbox"/>	<input type="checkbox"/>
21:00 - 00:00	<input type="checkbox"/>	<input checked="" type="checkbox"/>	<input type="checkbox"/>	<input checked="" type="checkbox"/>	<input type="checkbox"/>	<input checked="" type="checkbox"/>	<input type="checkbox"/>

12

Replacing a Drive

WD ShareSpace is a limited user-serviceable product which allows replacement of any or all internal hard drives in the enclosure.



.....
Important: The WD ShareSpace enclosure is designed to support only WD hard drive assemblies. Visit support.wdc.com and search the knowledge base article 2569 for detailed instructions on obtaining a replacement drive for this product. Use only WD hard drive assemblies or your warranty will be voided.

An amber LED on the front of the drive denotes a faulty drive. For more information on LEDs, see page 7. For more information on drive status, do the following:

1. Open WD Discovery and select the unit.
2. Click **Configure** and log in.
3. Click the **Advanced** view and then click the **Storage** tab.
4. Click the **Disk Management** button. The “Unassigned” drive is the defective one. Note the drive number for reference if you need to replace a drive.

In the event a fault occurs and you would like to service the device yourself, visit WD Technical Support at support.wdc.com and search the knowledge base article 2569 for detailed instructions on obtaining a replacement drive. When contacting Technical Support, have the following items ready: serial number of the device, date of purchase, and the serial number of the internal hard drive(s) which require replacement. Once you have received the replacement drive(s), follow the steps below to service the WD ShareSpace.

Before getting started, power off the unit and disconnect all of its cables.

ESD precautions

Electrostatic discharge (ESD) can damage the processor, disk drives, mainboard, memory modules, and other notebook components. Always observe the following precautions before you install a hard drive.

- Do not remove a component from its protective packaging until you are ready to install it.
- Do not touch the component pins, leads, or circuitry.
- Wear a wrist grounding strap and attach it to a metal part of the computer before handling components. If a wrist strap is not available, maintain contact with the computer throughout any procedure requiring ESD protection.
- Keep the work area free of nonconductive materials, such as ordinary plastic assembly aids and foam packing.

To replace an internal drive:

1. Turn off the system.
2. Unplug all cables from the power outlets.

3. Place the enclosure on a flat, stable surface.
4. Observe ESD precautions when handling a system component.
5. Remove the system cover.
 - (a) Loosen the two captive screws on the rear of the system cover.
 - (b) Slide the cover towards the back of the system until the tabs on the cover disengage from the slots on the unit.
 - (c) Lift the cover to remove it, and then set it aside.

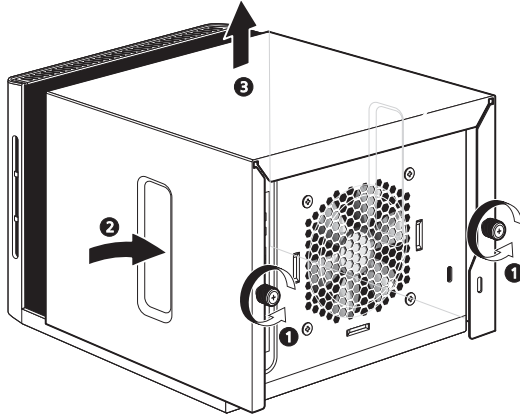

Note: The drive number is stamped to the left of the drive.

6. Remove the failed drive from the drive bay.



CAUTION: When pulling out the hard drive using the mounting rails handle, use your hand to support it from underneath so it does not fall.

- (a) Pull on the center of the mounting rails handle and move the assembly from side to side to disengage the side latches. Carefully slide the drive out 1 inch from its bay.

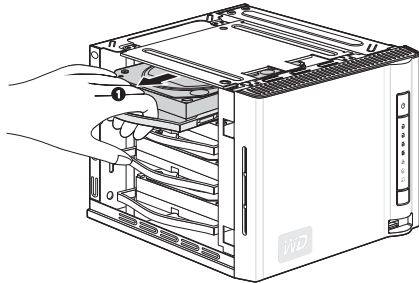

- (b) While pulling out the drive assembly with one hand, use your other hand to support the drive while sliding it out of the enclosure.

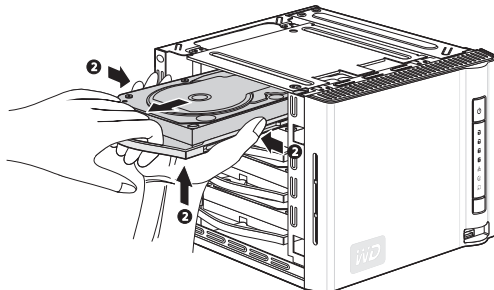

7. Remove the drive carrier.

- (a) Flex the back pin of the side rail from the hard drive and gently pull the side-rail away from the hard drive.
- (b) Remove the drive from the drive carrier.

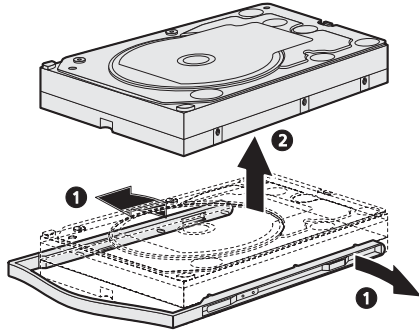

8. Remove the new hard drive from its packaging.

9. Install the new drive into the drive carrier.

- (a) Insert the new drive into the drive carrier.
- (b) Flex the left and right-side rail and insert the pins into the drive's mounting holes.

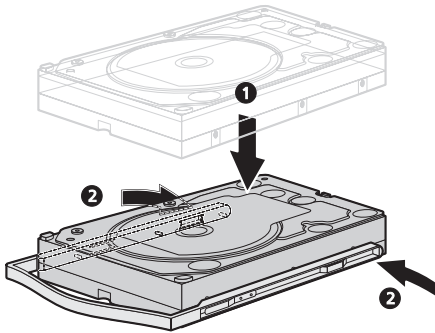

10. Slide the drive carrier all the way into the drive bay, then **push directly on the drive** (not on the mounting rails) until the assembly latches securely into place.

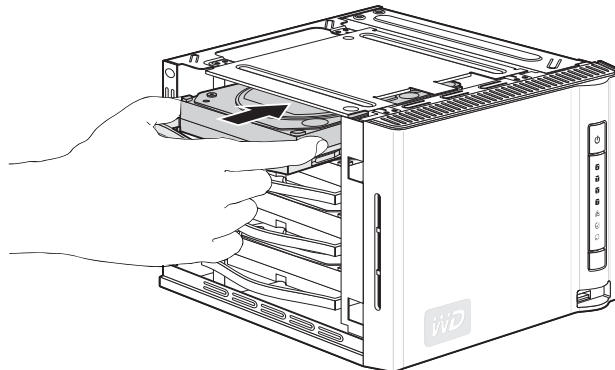

11. Replace the system cover.

- (a) Carefully place the system cover on the unit so that the tabs on the cover align with the slots on the unit.
- (b) Slide the cover toward the front of the unit until it is fully closed.
- (c) Tighten the captive screws on the rear of the unit.

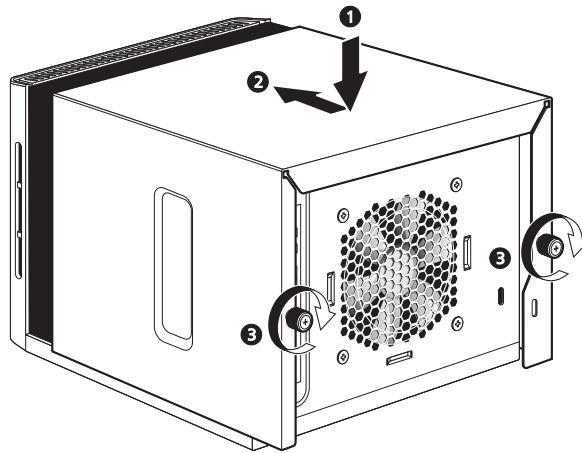

12. Reconnect the cables and power on the unit.

13. The drive starts the rebuild process automatically. The RAID rebuild may take up to 34 hours depending on RAID mode and drive capacity and activity. See the screen shot in “Volumes and RAID Management” on page 111.



.....
Important: Some RAID modes do not allow you to use the device during the rebuild process.



.....
Note: For RAID modes other than RAID 1 and RAID 5, data cannot be written until the rebuild is complete.

14. Once the rebuild is complete, the power LED will change from flashing green to steady green.

15. Connect the interface cable and set up the new drive for RAID configuration (for related instructions, refer to “Manage RAID” on page 114).

16. If the faulty drive is within the warranty period, contact WD Technical Support for instructions on returning the drive.



.....
Important: Do not disassemble the internal drive and attached assembly components. Return the entire internal drive assembly intact to WD.

13

Troubleshooting

For any issue, first ensure that you are using the latest firmware for WD ShareSpace. The latest firmware includes the latest network and SATA disk drivers. See “Update (Firmware)” on page 93 for instructions.

First Steps Checklist

- AC power available at the wall outlet?
- Is the power supply plugged in?
- Check the DC cable(s) on the back of the chassis and the AC source.
- Check the cable from the wall to the power supply and the cable from the power supply to the chassis.
- Are all cables correctly connected and secured?
- Are all peripheral devices installed correctly?
- Are all device drivers properly installed?
- Did you press the power button on the front panel to turn the device on (power indicator should be lit)?
- Is the power cord properly connected to the device and plugged into an outlet for 100-127 V or 200-240 V?

Resetting the WD ShareSpace

To reset the system using the reset button:

If you have forgotten your password, or if the network is misconfigured, pressing the reset button while the device is powered up resets the admin user name and password and IP settings to the default values without erasing shared folders or volumes. Follow the instructions below to reset the device using the recovery button.



.....

WARNING: Do not move the unit while it is turned on.

1. Carefully turn the device around so that you have access to the back of the unit.
2. Ensure that the device is powered on and that the LAN connection at the back of the device is active (designated by a green light).
3. Locate a single, small opening in the back of the device just above the power connector. The reset button is inside this opening.
4. Insert the end of an unfolded paperclip into the opening, then press and hold the reset button with the paperclip end. (*Do not release the button.*)

- Continue holding the reset button for about seven seconds until the HDD LEDs on the front panel light up. After 14 seconds, the HDD LEDs turn amber.

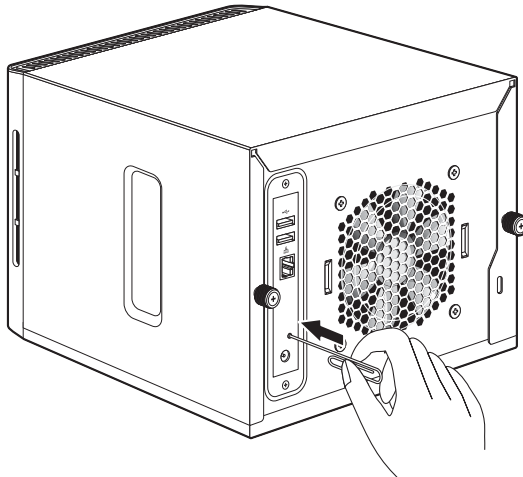

- Release the reset button by removing the paperclip. The device will automatically reboot.

The reset operation is complete when the device has rebooted and the LAN connection lights and HDD LEDs are on. A successful reset results in restoring the device name, IP address, admin user name, and admin password to factory default (WDShareSpace, DHCP client, admin and admin).



.....
Note: The default user name and password is **admin**.

To reset the system to factory default settings:

Performing a factory default reset using the WD ShareSpace's Network Storage Manager erases all settings, shares, and data files in the WD ShareSpace. All information and data is lost. For detailed instructions, see "To restore the device to factory defaults:" on page 96.

Hardware Diagnostic Testing

This section provides a detailed approach to identifying a hardware problem and locating its source.



.....
CAUTION! Before disconnecting any peripheral cables from the system, turn off the WD ShareSpace and any external peripheral devices. Failure to do so can cause permanent damage to the WD ShareSpace and/or the peripheral device.

- Turn off the WD ShareSpace and all external peripheral devices.
- Make sure the power cord is plugged into a properly grounded AC outlet.
- Turn on the device. If the power indicator on the front panel does not light, see "Power indicator does not light." on page 153.

Specific Problems and Corrective Actions

The following contains specific problems that may arise during the use of your server. Possible solutions are listed for each problem.

Power indicator does not light.

Do the following:

- Make sure the power button on the control panel is turned on.
- Make sure the power cord is connected correctly.
- Make sure that the wall outlet has power. Test it by plugging another device.

HDD activity indicator does not light.

If the drives are pre-installed, contact WD Technical Support (support.wdc.com). Make sure that WD hard drives are installed in the WD ShareSpace.

System cannot connect to a network and network status indicator does not light.

- Make sure the network cable is securely attached to the correct connector on the rear panel of the device.
- Try a different network cable.
- Make sure the network switch or router has power.

Do the following:

- Check the cabling and network equipment to make sure that all cables are properly connected.
- Try another port on the switch.

Can I use USB auto backup to back up a USB drive with multiple partitions to the device?

Yes, but only data stored on the first partition of a USB drive connected to the front port is backed up to the WD ShareSpace.

WD ShareSpace's Network Storage Manager does not appear when I click Configure in WD Discovery.

Make sure JavaScript is enabled in your browser. See your browser's Help menu for instructions.

I received a banner warning message, email alert, or pop-up screen indicating a failed volume.

Do the following:

1. Verify hard drive status in the Disk Manager submenu. See “Disk Manager” on page 110. If the status of any drive is “Failed,” visit WD Technical Support at support.wdc.com and search the knowledge base article 2569 for detailed instructions on obtaining a replacement drive.
2. If Disk Manager does not indicate that a hard drive has failed, power cycle the device.
3. If the volume that failed is a new volume, try rebuilding the RAID array. See “Manage RAID” on page 114 for details. If this does not resolve the problem, visit WD Technical Support at support.wdc.com and search the knowledge base article 2569 for detailed instructions on obtaining a replacement drive.

My router has failed or is not available. How do I access my data in the device?

Do the following:

1. Connect the device directly to the computer's Ethernet port.

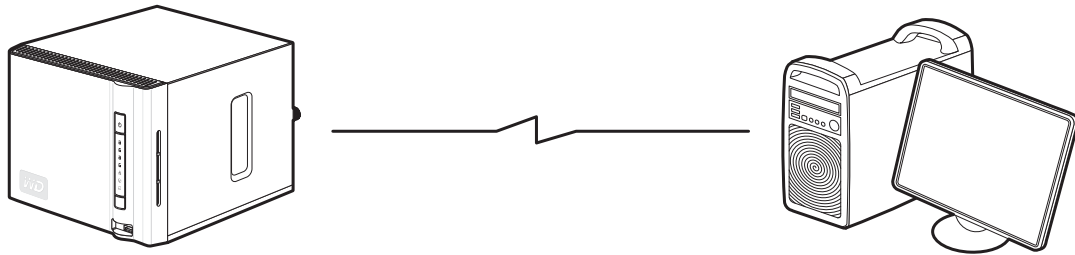

2. Launch WD Discovery Tool and see “Mapping a Network Drive” on page 63 for instructions on how to access data in the device.

I received the message “iTunes server cannot find the path to Shared Music.”

The iTunes server requires the presence of the /Public/Shared Music share folder. Do not rename or delete Shared Music if you want to use the iTunes server. You must recreate or rename the /Public/Shared Music share if it has been deleted or given another name.

I cannot start WD Discovery to access the configure feature.

Do the following:

1. Click **Start > Run**.
2. Type \\WDSHareSpace, and then click **OK** (if the device name was changed, type \\yournewdevicename).
3. The WD ShareSpace directory appears (Public, Configuration, and Download folders). Double-click the Configuration folder.
4. Double-click index.html. The configuration login screen appears.

My router has failed. How do you map the drive letter without WD Discovery Tool?

Do the following:

1. Double-click **My Computer**.
2. Click **My Network Places**.
3. On the **Tools** menu, point to **Map Network Drive**.
4. In the **Folder** drop-down list, select \\device name\public.

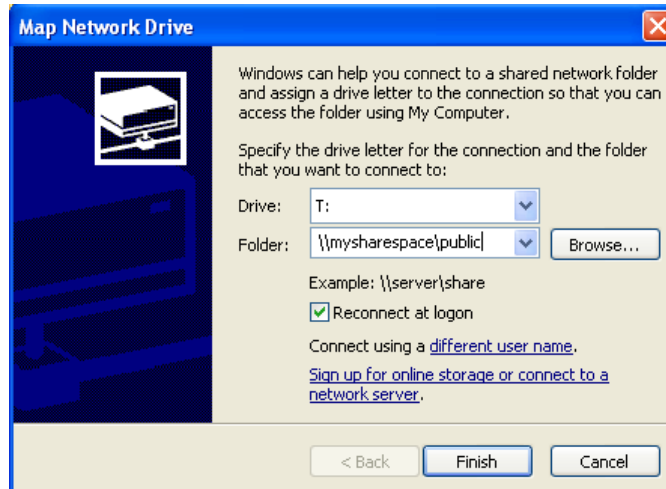

5. Click the **Finish** button. You will be prompted to log in to the share.
6. Go back to the opening window of **My Computer** to view the public folder of your device under **Network Drives**.

I am unable to play music, videos, or view pictures through my digital media adapter.

The media adapter requires the presence of the /Public/Shared Music, /Public/Shared Pictures and /Public/Shared Videos share folder. Do not rename or delete the shared folders if you want to use the media adapter. You must recreate or rename the share if it has been deleted or named something else.

Because there are many kinds of file formats for pictures, videos and music, your particular digital media adapter may not support a format to play or display it. Depending on the digital media adapter device (for example, Xbox, PS3, Windows, and Media Center) that you have, you may need to update your device with the proper CODECs to support the media format that you want to play. Please refer to your digital media adapter's user manual for further information of how to locate and update CODECs.

System Events

The following table describes the event types that are recorded in the system log.

Event type and Event ID	Event state	Event value	Critical	Warning
System events				
Startup	[none]			
Abnormal Shutdown	[none]			✓
Shutdown	[none]			✓
Reboot	[none]			✓
Software Update	Succeeded	Version		
Software Update	Failed			✓
Factory Default	Succeeded			
Configuration Restore	Succeeded			
Configuration Restore	Failed			✓
iTunes Directory	Not Exist			✓
Fan thermal events				
Fan 1	Normal	RPM		
Fan 1	Failed*		✓	✓
Thermal 1	Normal	Degrees		
Thermal 1	Exceeded the threshold (Overheated)	Degrees	✓	✓
HDD SMART events				
HDD [1,2,3,4]	HDD SMART OK			
HDD [1,2,3,4]	HDD SMART fail		✓	✓
Volume events				
Volume [1,2]				
Volume [1,2]	RAID volume in normal mode			
Volume [1,2]	RAID volume in degraded mode		✓	✓
Volume [1,2]	RAID(0,1,5) volume resyncing	Progress		✓
Volume [1,2]	Sent if volume could not be recovered		✓	✓
Volume [1,2]	Volume doesn't exist		✓	✓
Volume [1,2]	Volume created			✓
Volume [1,2]	Volume deleted			✓
Volume [1,2]	Volume modified			
Volume usage events				
Volume [1,2]				
Volume [1,2]	Volume has 25~100% free capacity			

Event type and Event ID	Event state	Event value	Critical	Warning
Volume [1,2]	Volume has more than 10% free capacity			
Volume [1,2]	Volume has more than 5% free capacity			
Volume [1,2]	Volume has reached 80% capacity			✓
Volume [1,2]	Volume has reached 95% capacity		✓	✓
Volume [1,2]	Volume has reached full capacity		✓	✓
Volume [1,2]	Volume had NOT been mounted		✓	✓
Network events				
LAN 1	Link Ok	Speed (Mbps: 1000/100/10)		
LAN 1	Link down			✓
LAN 1	Use dynamic IP address got from DHCP	IP address		
LAN 1	Can not get IP address from DHCP, use default	IP address		
LAN 1	Use static IP address	IP address		
USB events				
USB [1]	One-touch backup to external drive did not finish because external drive is full		✓	✓
USB [1,2,3]	USB drive insertion			
USB [1,2,3]	USB drive safely removed			
USB [1,2,3]	USB drive unsafely removed			✓
USB [1,2,3]	USB drive format OK			
USB [1,2,3]	USB drive format fail			
User events				
[User ID]	User quota is normal			
[User ID]	User quota reached 90%			
[User ID]	User quota is full			✓
[User ID]	User created			
[User ID]	User deleted			
[User ID]	User modified			
Group events				
[Group ID]	Group created			
[Group ID]	Group deleted			✓

Event type and Event ID	Event state	Event value	Critical	Warning
[Group ID]	Group modified			
Other events				
Volume [1,2]	Volume extend failed		✓	✓
Volume [1,2]	Volume resync failed		✓	✓

* A fan failed event is issued when the device temperature is greater or equal to 40°C (104°F).

Glossary

CIFS — Common Internet File System. The recommended file sharing protocol for Windows platform allows users to access shares through My Network Places. Mac OS X or later also supports the CIFS protocol. See also *Protocol*.

DHCP — Dynamic Host Configuration Protocol. A protocol for assigning IP addresses to devices on a network. With dynamic addressing, a device can have a different IP address each time it connects to the network. In some systems, the device's IP address even changes while it is still connected. DHCP also supports a mix of static and dynamic IP addresses. See also *Protocol*.

DLNA — Digital Living Network Alliance. The group of consumer electronics, computing industry, and mobile device companies that sets standards for product compatibility, thus enabling users to share content in their home.

DMA — Digital Media Adapter. A device that gives home entertainment devices the ability to transfer media such as music, photos, videos to and from other devices over the network.

DNS — Domain Name Service. A system that allows a network name server to translate text host names into numeric IP addresses used to uniquely identify any device connected to the Internet.

ESD — Electrostatic discharge.

Ethernet — A standard method of connecting computers to a Local Area Network (LAN) using coaxial cable.

Extended Partition — A partition on a disk where non-system files (other than DOS or operating system files) can be stored. Multiple partitions can be created on a hard disk: one primary partition and one or more extended partition(s). Operating system files must reside on the primary partition; logical drives can be created on an extended partition.

FAT — File Allocation Table. A data table stored at the beginning of each partition on a disk and used by the operating system to determine which sectors are allocated to each file and in which sequence.

FAT32 — A file allocation table system with a maximum file transfer of 4 GB and a maximum partition size of 32 GB.

File Transfer Protocol (FTP) — A network protocol used to transfer data from one computer to another through a network. FTP is a popular choice for exchanging files independent of the operating systems involved.

GreenPower™ Technology — Engineering technology developed by WD to bring more energy-efficient hard drive options to our customers. WD hard drives with GreenPower technology yield average power savings of 4-5 watts over competitors' drives while maintaining solid performance.

Host — The computer to which other computers and peripherals connect.

Host Adapter — A plug-in board that acts as an interface between a computer system bus and a hard drive.

Host Interface — The point at which a host and a drive are connected to each other.

Host Transfer Rate — The speed at which a host computer can transfer data across an interface.

HTTP — Hypertext Transfer Protocol. Protocol used by the World Wide Web to transfer information between servers and browsers. See also *Protocol*.

HTTPS — Hypertext Transfer Protocol over Secure Socket Layer. A protocol that provides a more secure means of configuring your device than HTTP, but may affect the responsiveness of the user interface. All traffic between the managing computer and the WD ShareSpace is encrypted. See also *Protocol*.

Hub — In a network, a device joining communication lines at a central location, providing a common connection to all devices on the network.

Identity LED — Indicates which WD ShareSpace in the network is currently being accessed via WD Discovery.

Interface — A hardware or software protocol to manage the exchange of data between a device and a computer; the most common ones are EIDE (also known as PATA), SATA, and SCSI. See also *Protocol*.

IP — Internet Protocol. A system that controls how data messages are separated into packets, routed from the sender, and reassembled at the destination. See also *Protocol*.

IP address — A 32-bit, binary number that uniquely identifies a computer connected to the Internet.

LAN — Local Area Network. A system in which computer users in the same company or organization are linked to each other and often to centrally-stored collections of data in LAN servers.

LED — Light-emitting Diode. An electronic device that lights up when electricity is passed through it.

Media Server — Device that stores and shares media files (digital audio, digital video, and digital photos).

Media Storage — Device that stores media files (digital audio, digital video, and digital photos).

Memory — A device or system capable of storing and retrieving data.

MioNet[®] — WD remote computer access service. Adding MioNet to your home or work computer allows you secure and instant access from any PC in the world back to your computer. You can use your applications and access and share files on your computer or storage device from anywhere.

Mirroring — The process of generating an exact copy of saved data from one drive to another drive within a RAID 1 system. Each drive can be accessed and read separately. A mirrored drive can be removed from a system while the other drive(s) are still active. See also *RAID 1*.

MP3 — MPEG-audio layer 3. A digital audio coding scheme for distributing music over the Internet.

Multi-user — A system in information technology that enables more than one user to access data at the same time.

NAS — Network Attached Storage. Hard disk storage that is set up with its own network address rather than being attached to the computer that is serving network workstation users.

NAT — Network Address Translation. Used in gateway devices that form the boundary between the public Internet and the private LAN. As IP packets from the private LAN traverse the gateway, NAT translates a private IP address and port number to a public IP address and port number, tracking those translations to keep individual sessions intact.

Network Computer — A computer that communicates with a central data storage facility such as a server or RAID system.

NFS — Network File System. A network file system protocol that allows a user on a client computer to access files over a network as easily as if the network devices were attached to its local disks. Normally associated with UNIX systems. See also *Protocol*.

NTFS — NT File System. A file system, designed for Windows® NT, that supports long filenames, security access control, recovery, and other features.

NTP — Network Time Protocol. A protocol for synchronizing the clocks of computers and equipment over a network. See also *Protocol*.

Operating System — Software that allows users and programs installed on your system to communicate with computer hardware such as a hard drive.

Partition — A logical division on a hard drive that the operating system treats as a separate hard drive. Each partition is assigned a unique drive letter.

Port (Hardware) — A specialized outlet on a device for connecting to other devices using a cable or a plug. Ethernet ports, power ports, and USB ports are examples.

Protocol — A convention of data transmission that defines timing, control format, and data representation.

RAID — Redundant Array of Independent Disks. A grouping of hard drives in a single system to provide greater performance and data integrity.

RAID 0 — RAID protocol in which data is striped across multiple hard drives, enabling the accelerated reading and recording of data by combining the work of two or more drives to increase performance. See also *Striping*.

RAID 1 — RAID protocol in which two copies of the data are instantaneously recorded — each on separate hard drives. RAID 1 ensures the protection of users' data because in the event that one of the hard drives fails, the other hard drive(s) will continue to read and write data until the faulty hard drive is replaced and rebuilt to once again safely mirror the data. See also *Mirroring*.

RAID 5 — For systems with three or more drives, RAID 5 offers fast performance by striping data across all drives. It protects data by dedicating a quarter of each drive to fault tolerance, leaving three quarters of the system capacity available for data storage.

RAM — Random Access Memory. Memory that allows any storage location to be accessed randomly, as opposed to sequential access devices such as tape drives.

ROM — Read-Only Memory. An integrated circuit memory chip containing programs and data that the computer or host can read but cannot modify. A computer can read instructions from ROM but cannot store data in ROM.

Share — A folder that can be used to organize and store files on your WD ShareSpace. Shares can be shared with everyone (public) or with selected users on your network (private).

SMB — Server Message Block. File-sharing protocol for Windows platform that allows users to access shares through My Network Places. Mac OS X or later also supports the CIFS protocol. See also *Protocol*.

SMTP — Simple Mail Transfer Protocol. Standard for transferring e-mail across the Internet. See also *Protocol*.

Spanned — Combines drives in a linear fashion to create one large logical volume. A spanned drive is like a single, bigger drive, in that files written to the volume earlier go to the “beginning” of the volume, on the first physical drive. If one of the drives fails, all data is lost.

SSH — Secure Shell. A network protocol that uses encryption and authentication keys to enable two devices on the network to exchange data securely. See also *Protocol*.

SSL — Secure Socket Layer. A protocol that provides authentication and encryption services between a web server and a web browser. See also *Protocol*.

Streaming Media — Media such as audio, video, and photos that are constantly received while being delivered by a streaming provider.

Striping — The spread of data over multiple hard drives to improve performance. See also *RAID 0*.

TCP/IP — Transmission Control Protocol/Internet Protocol. A set of protocols for communication over interconnected networks. The standard for data transmission over networks. See also *Protocol*.

TLS — Transport Layer Security. Successor to SSL. See also *SSL*.

Two Mirror Mode — Two Mirror mode is available when four drives are installed in a device. In this mode, two independent RAID 1 volumes are created.

Twonky Media Server — A server application that searches for all the media (for example, videos, photos, and music) stored on the WD ShareSpace connected to your home network.

UPnP — Universal Plug n Play. A set of computer network protocols that simplify the implementation of networks in the home by allowing devices to connect seamlessly. See also *Protocol*.

UPnP NAT Traversal — Combines UPnP and NAT features.

UPS — Uninterruptable Power Supply. A standalone device that provides secondary power to connected equipment in the event of a power failure.

USB — Universal Serial Bus. A serial bus for connecting peripherals to a microcomputer. It connects external drives, printers, modems, mice, keyboards, etc., through a single, general-purpose port. It can automatically add and configure new devices without having to shut down and restart the system.

USB 2.0 — For most PCs, the standard interface is USB. Hi-Speed USB (USB 2.0) supports data transfer rates up to 480Mb/s. USB 2.0 is backward-compatible with USB 1.1. — If you connect to a USB 1.1 device, data is transferred at USB 1.1 speed (up to 1.1 Mb/s).

WAN — Wide Area Network. A computer network that crosses metropolitan, regional, or national boundaries.

WD Anywhere Backup — WD backup software that allows the user to set up continuous backup of all or selected files for up to five computers in a network. This feature backs up your data to the WD ShareSpace so you can restore your data in the event that a computer's hard drive crashes.

WD Discovery™ — WD software application that allows the host computer to find one or more WD network storage systems in the same network segment.

Appendix

Regulatory Compliance

FCC Class B Information

This device has been tested and found to comply with the limits of a Class B digital device, pursuant to Part 15 of the FCC Rules. These limits are designed to provide reasonable protection against harmful interference in a residential installation. This unit generates, uses, and can radiate radio frequency energy and, if not installed and used in accordance with the instructions, may cause harmful interference to radio or television reception. However, there is no guarantee that interference will not occur in a particular installation. Any changes or modifications not expressly approved by WD could void the user's authority to operate this equipment.

The following booklet, prepared by the Federal Communications Commission, may be helpful: *How to Identify and Resolve Radio/TV Interference Problems*. This booklet is Stock No. 004-000-00345-4 available from the US Government Printing Office, Washington, DC 20402.

The provided Ethernet cable must be used between the unit and network connection to comply with FCC Part 15 Class B and EN-55022 Class B.

ICES/NMB-003 Compliance

Cet appareil de la classe B est conforme à la norme NMB-003 du Canada.

This device complies with Canadian ICES-003 Class B.

Safety Compliance

Approved for US and Canada. CAN/CSA-C22.2 No. 60950-1, UL 60950-1: Safety of Information Technology Equipment.

Approuvé pour les Etats-Unis et le Canada. CAN/CSA-C22.2 No. 60950-1 : Sûreté d'équipement de technologie de l'information.

This product is intended to be supplied by a listed limited power source, double insulated, or direct plug-in power unit marked "Class 2."

CE Compliance for Europe

Verified to comply with EN55022 for RF emission; EN-55024 for Generic Immunity, as applicable; and EN-60950 for Safety.

Environmental Compliance (China)

有毒有害物质或元素名称及含量标识 Toxic / Hazardous Substances and Elements Table

部件名称	有毒有害物质或元素					
	铅 (Pb)	汞 (Hg)	镉 (Cd)	六价铬 (Cr (VI))	多溴联苯 (PBB)	多溴二苯醚 (PBDE)
机架 chassis	×	○	○	○	○	○
外部盖板 external covers	×	○	○	○	○	○
机械组合件 mechanical assemblies	○	○	○	○	○	○
冷却组合件 cooling assembly	○	○	○	○	○	○
空气传动设备 air moving devices	○	○	○	○	○	○
电源 power supply	○	○	○	○	○	○
处理器模块 processor modules	×	○	○	○	○	○
内存模块 memory modules	×	○	○	○	○	○
电池 batteries	○	○	○	○	○	○
电缆组合件 cable assemblies	○	○	○	○	○	○
存储设备 storage device	×	○	○	○	○	○
有 mech 的电路卡 circuit cards with mechs	×	○	○	○	○	○
无 mech 的电路卡 circuit cards w/o mechs	×	○	○	○	○	○

○：表示该有毒有害物质在该部件所有均质材料中的含量均在SJ/T 11363—2006规定的限量要求以下。

×：表示该有毒有害物质至少在该部件的某一均质材料中的含量超出SJ/T 11363—2006规定的限量要求。

环保使用期限 (EPUP) 的免责条款：EPUP 规定的具体期限仅为符合中华人民共和国的相应的法律规定，并非代表 IBM 向客户提供保证或负有任何义务。EPUP 中假定客户按照操作手册在正常情况下使用本产品。对于本产品中配备的某些组合件 (例如，装有电池的组件) 的 EPUP，其效力可能低于本产品的 EPUP。

Warranty Information

Obtaining Service

WD values your business and always attempts to provide you the very best of service. If this Product requires maintenance, either contact the dealer from whom you originally purchased the Product or visit our product support website at support.wdc.com for information on how to obtain service or a Return Material Authorization (RMA). If it is determined that the Product may be defective, you will be given an RMA number and instructions for Product return. An unauthorized return (i.e., one for which an RMA number has not been issued) will be returned to you at your expense. Authorized returns must be shipped in an approved shipping container, prepaid and insured, to the address provided on your return paperwork. Your original box and packaging materials should be kept for storing or shipping your WD product. To conclusively establish the period of warranty, check the warranty expiration (serial number required) via support.wdc.com. WD shall have no liability for lost data regardless of the cause, recovery of lost data, or data contained in any Product placed in its possession.

Limited Warranty

WD warrants that the Product, in the course of its normal use, will be free from defects in material and workmanship for a period of three (3) years, unless otherwise required by law, and will conform to WD's specification therefor. This limited warranty period shall commence on the purchase date appearing on your purchase receipt. WD shall have no liability for any Product returned if WD determines that the Product was stolen from WD or that the asserted defect a) is not present, b) cannot reasonably be rectified because of damage occurring before WD receives the Product, or c) is attributable to misuse, improper installation, alteration (including removing or obliterating labels and opening or removing external enclosures, including the mounting frame, unless the product is on the list of limited user-serviceable products and the specific alteration is within the scope of the applicable instructions, as found at *support.wdc.com*), accident or mishandling while in the possession of someone other than WD. Subject to the limitations specified above, your sole and exclusive warranty shall be, during the period of warranty specified above and at WD's option, the repair or replacement of the Product. The foregoing warranty of WD shall extend to repaired or replaced Products for the balance of the applicable period of the original warranty or ninety (90) days from the date of shipment of a repaired or replaced Product, whichever is longer.

The foregoing limited warranty is WD's sole warranty and is applicable only to products sold as new. The remedies provided herein are in lieu of a) any and all other remedies and warranties, whether expressed, implied or statutory, including but not limited to, any implied warranty of merchantability or fitness for a particular purpose, and b) any and all obligations and liabilities of WD for damages including, but not limited to accidental, consequential, or special damages, or any financial loss, lost profits or expenses, or lost data arising out of or in connection with the purchase, use, or performance of the Product, even if WD has been advised of the possibility of such damages. In the United States, some states do not allow exclusion or limitations of incidental or consequential damages, so the limitations above may not apply to you. This warranty gives you specific legal rights, and you may also have other rights which vary from state to state.

GNU General Public License ("GPL")

Firmware incorporated into My Book World Edition includes third party copyrighted software licensed under the GPL ("GPL Software"). In accordance with the GPL: 1) the source code for the GPL Software may be obtained at *support.wdc.com/download/gpl*; 2) you may re-use, re-distribute and modify the GPL Software; 3) with respect solely to the GPL Software, it is provided "as is" without warranty of any kind, either expressed or implied, including, but not limited to, the implied warranties of merchantability and fitness for a particular purpose, to the extent permitted by applicable law; and 4) a copy of the GPL is included on the enclosed CD, may be obtained at *www.gnu.org*, and may also be found at *support.wdc.com/download/gpl*.

When contacting WD for support, have your WD product serial number, system hardware, and system software versions available.

Information furnished by WD is believed to be accurate and reliable; however, no responsibility is assumed by WD for its use nor for any infringement of patents or other rights of third parties which may result from its use. No license is granted by implication or otherwise under any patent or patent rights of WD. WD reserves the right to change specifications at any time without notice.

Western Digital, WD, the WD logo, My Book, WD Caviar and MioNet are registered trademarks in the U.S. and other countries; and World Edition, Green, and WD Discovery are trademarks of Western Digital Technologies, Inc. Other marks may be mentioned herein that belong to other companies.

© 2009 Western Digital Technologies, Inc. All rights reserved.

4779-705006-A04 April 2009

Index

A

- active directory service 105
- admin login password
 - change 92
- ADS 105
- audio
 - streaming in iTunes 58, 127
- auto backup 60

B

- backup
 - automatic and complete 25
 - logs 39
 - restore 35
- backup button 8
- backup data
 - system to USB hard drive 61
 - USB hard drive to system 61
- backup plan 27
 - customized 27
 - edit 37
 - icons 37
 - remove 39
 - restore 35

C

- CE compliance 164
- change password
 - downloader 124
- China RoHS 165
- compliance, regulatory 164
- configuration menu 95
- customized backup plan 27

D

- data backup 60
- date & time 79
- deleting a backup plan 39
- destination share
 - setup 120, 124
- device name 79
- digital media adapter 57
- digital picture frames 56
- disk manager 110
- DLNA media device 57
- download queue
 - change order 145
- download task

- create 144
- Downloader 141
 - access 141
 - command icons 143
 - features 142
 - UI overview 142
 - using 144
- Downloader destination share
 - setup 124
- Downloader password
 - change 124
- Downloader settings
 - configure 145
- downloads menu 124
- drive format 3

E

- e-mail notifications
 - setup 90
- environmental compliance (China) 165
- ESD precautions 147
- Europe, CE compliance 164

F

- FCC 164
- FCC Class B information 164
- features
 - backup button 8
 - ports 8
 - reset button 8
 - security slot 8
- file sharing protocols 117
- file storage 17
- firmware update 93
- folder share permissions 131
- folder shares 116
- format and configuration 3

G

- general setup 88
- general setup settings
 - configure 89
- getting started 3
- glossary 159
- GNU general public license 166
- GPL software 166
- group account
 - create 130

group accounts
 assign access rights 132

H

hardware setup
 connect the system 9

I

ICES/NMB-003 compliance 164
indicators 7
iTunes server service 126
 enable 126
 streaming audio 58, 127

K

kit contents 4

L

LAN submenu 101
limited warranty 166
log settings
 configure 140
logs
 settings 139
 system 137

M

Macintosh
 installing WD Anywhere Backup 20
Macintosh Leopard
 accessing WD ShareSpace 20
Macintosh Tiger
 accessing WD ShareSpace 24
manage RAID 114
 configure 115
 options 116
manage volume 111
 options 113
Media 125
media
 devices 53
 iTunes 126
 storage 52
media server 125
media types supported 51
MioNet
 accessing files 45
 remote access setup 41
 sharing files 45
 sharing photos 45
 transferring files 48

MioNet Web 44

N

network 101
 LAN 101
 services 103
 shares 17
 workgroup setup 105
network drive
 mapping 63
network mode 80
network music player 57
network service
 enabling 104
network settings configuration 101
network shares 66
Network Storage Manager 69
 accessing 74
 Mac 75
 Windows 74
 advanced mode 87
 basic mode 78
 features 76
 network tab 101
 status tab 136
 storage tab 109
 system tab 88
 toolbar 78
 UI overview 77
 users tab 128
 using 69
network storage system
 using 147

O

obtaining service 165
one-click backup 24

P

permissions
 folder share 131
 USB share 133
pop-up message alert
 setup 91
ports 8
power button 6
pre-installation requirements 5
product registration 2

Q

quota

- configure 122
- R**
- RAID
 - levels 114
 - management 111
 - options 116
- Rally for Windows Vista 11
- reboot 86
- recovery button 151
- registration, product 2
- regulatory compliance 164
- remote access
 - MioNet 41
- reset button 8
- restore 95
 - system to factory defaults 96
- restoring a backup plan 35
- RoHS 165
- S**
- safety compliance 164
- safety instructions 2
- scheduled downloads
 - creating 141, 147
- security slot 8
- Service
 - WD 165
- shares 116
 - access data 66
 - browse 66
 - create 84, 117
 - delete 84
- shortcut creation 67
- shutdown 86
- shutdown/reboot 86
- software, GPL 166
- source share 121
- specifications 3
- status 136
 - logs
 - CIFS 138
 - settings 139
 - system status 136
- storage 109
 - disk manager 110
 - downloads 124
 - change password 124
 - setup destination share 124
 - folder shares 116
 - quota 121, 123
 - datavolume user quota 123
 - manage quota 121
 - user 123
- usb shares 119
 - usb disk 119
 - usb to network storage system backup 120
 - WD ShareSpace to USB backup 121
- volumes 111
 - manage RAID 114
 - manage volume 111
- system 88
 - admin password 92
 - advanced 97
 - alerts setup 90
 - configuration 95
 - general setup 88
 - remote access 107
 - restart 100
 - restore 95
 - update firmware 93
 - UPS 99
- system configuration settings
 - restore 96
 - save 95
- system events specification 156
- system logs 137
- system logs records
 - event type 138
 - system conditions or error 137
- system requirements 5
- system status 85, 136
- system tour 8
 - LED indicators 7, 9
- system view 6
- T**
- troubleshooting 151
 - checklist 151
 - hardware diagnostic testing 152
 - problems
 - cannot connect to a network 153
 - cannot start configuration 154
 - digital media adapter not working 155
 - failed volume 154
 - HDD LED no light 153
 - iTunes not finding path 154
 - LAN LED no light 153
 - Network Storage Manager not appearing 153
 - no video 153
 - power indicator no light 153
 - router and WD Discovery unavailable 155
 - router failed 154
 - resetting the system 151
- Twonky Media server 125

U

- UL 164
- Underwriters Laboratories Inc. 164
- UPnP NAT Traversal 104
- UPS service
 - enabling 99
- USB Disk tab 119
- USB hard drive
 - disconnect 120
 - format 119
 - USB sharing 60
- USB share
 - assign access rights 134
 - permissions 133
- USB share permissions 133
- user account
 - assign privilege 132
 - create 82, 129
 - delete 130
 - modify 130
- user quota 123
- users
 - folder shares 131
 - groups 130
 - usb shares 133
- Using 44

V

- Vista Rally driver 11
- volume
 - delete 112
 - modify 112

W

- warranty 165
- warranty, limited 166
- WD 153
- WD Anywhere Backup
 - configuring 24
- WD Discovery
 - browse network shares 66
 - desktop shortcut creation 67
 - identify LED 67
- WD ShareSpace 66
 - configuring 69
 - using shares 60
- Windows 75
 - configuring MioNet 41
 - installing WD Anywhere Backup 18
- Windows Media Player 53
- workgroup

- create 106
- menu 105

X

- Xbox 360 55