



PRO-1000 series Online Manual

Read Me First
Printer Functions
Printing
Troubleshooting

Contents

Using This Online Manual.	17
Trademarks and Licenses.	18
Search Tips.	26
Printer Functions.	28
Connect Wirelessly with Ease in "Direct Connection".	29
Print Photos Easily Using My Image Garden.	30
Download a Variety of Content Materials.	32
Print Items with Easy-PhotoPrint+ (Web Application).	33
Managing Printer Conveniently Using Quick Utility Toolbox.	34
Available Connection Methods.	35
Restrictions.	37
Print Professional Photos Using Print Studio Pro.	39
Browse/Print Photo Items Using Pro Gallery Print.	40
Managing Paper Information on Printer Using Media Configuration Tool.	41
Managing Printer Status Using Device Management Console.	42
Using PIXMA/MAXIFY Cloud Link.	43
Notice for Web Service Printing.	44
Using PIXMA/MAXIFY Cloud Link from Your Smartphone, Tablet, or Computer.	45
Before Using Canon Inkjet Cloud Printing Center.	46
Requirements for Canon Inkjet Cloud Printing Center operation.	47
Registering User Information to Canon Inkjet Cloud Printing Center.	48
Registering User Information to Canon Inkjet Cloud Printing Center (No LCD Monitor/Using PRO-1000 series or PRO-500 series).	49
Using Canon Inkjet Cloud Printing Center.	55
Canon Inkjet Cloud Printing Center window.	59
Adding a Printer.	96
Adding a PIXMA/MAXIFY Cloud Link User.	98
Troubleshooting Canon Inkjet Cloud Printing Center.	103
Print Easily from a Smartphone or Tablet with Canon PRINT Inkjet/SELPHY.	106
Printing with Windows RT.	107
Handling and Use of Paper.	108
Paper.	109

Media Types You Can Use.	110
Paper Load Limit.	112
Media Types You Cannot Use.	114
Handling Paper.	115
Before Printing on Art Paper.	116
Handling Paper.	118
Paper Sources to Load Paper.	119
Loading Paper in the Rear Tray.	120
Loading Paper in the Manual Feed Tray.	124
Making Settings from Operation Panel or Web Browser.	127
Operation Panel.	128
LCD and Operation Panel.	129
Changing Settings from Operation Panel/Web Browser.	132
Changing Settings from Operation Panel.	133
Changing Settings from Operation Panel.	134
Setting Items on Operation Panel.	136
Administrator password setting (Item for administrator).	137
Setting Administrator Password on Operation Panel.	138
Device user settings (Item for administrator).	140
Web service setup (Item for administrator).	141
Language selection (Item for administrator).	142
Energy saving settings (Item for administrator).	143
Quiet setting (Item for administrator).	144
Paper Settings.	145
Print settings.	149
PictBridge print settings.	150
Paper-related settings.	152
Job management.	153
Firmware update (Item for administrator).	154
Printer information.	155
LAN settings (Item for administrator).	156
Auto maintenance settings (Item for administrator).	163
Maintenance page size.	164
Reset setting (Item for administrator).	165
Changing Printer's Setting Using Web Browser.	166
Changing Settings Using Web Browser.	167
Changeable Setting Items Using Web Browser.	169

Setting Password.	171
Printer Parts.	173
Front View.	174
Rear View.	176
Power Supply.	178
Confirming that the Power Is On.	179
Turning the Printer On and Off.	180
Notice for the Power Plug/Power Cord.	182
Notice for Unplugging the Power Cord.	183
Network Setting.	184
Network Connection.	185
Network Connection Tips.	186
Default Network Settings.	187
Another Printer Found with Same Name.	189
Printing Network Settings.	190
Changing LAN Connection Method/Changing Wireless LAN Connection Method (Windows).	195
Adjustments for Better Print Quality.	196
Aligning the Print Head.	197
Aligning the Print Head Manually.	199
Color Management.	202
Managing Colors.	203
Performing Color Calibration Using the Operation Panel.	204
Performing Color Calibration from Quick Utility Toolbox.	207
Paper that Can Be Used in Color Calibration.	211
Maintenance and Consumables.	213
Maintenance Procedure.	215
Ink Tanks.	217
Ink.	218
Replacing Ink.	220
Checking the Ink Status with the LCD on the Printer.	225
Print Head.	226
Printing the Nozzle Check Pattern.	227
Examining the Nozzle Check Pattern.	229

Cleaning the Print Head.	231
Cleaning the Print Head Deeply.	233
Performing the System Cleaning.	235
Performing Maintenance Functions from Your Computer (Mac OS).	237
Cleaning the Print Heads.	238
Printing a Nozzle Check Pattern.	241
Checking the Ink Status from Your Computer.	242
Maintenance Cartridge.	243
Replacing the Maintenance Cartridge.	244
Checking the Maintenance Cartridge Status with the LCD on the Printer.	247
Cleaning the Printer.	248
Cleaning the Exterior of the Printer.	249
Cleaning the Paper Feed Roller.	250
Cleaning the Inside of the Printer (Bottom Plate Cleaning).	252
Other Maintenance.	254
Relocating Your Printer.	255
Transporting Your Printer.	256
Specifications.	260
Specifications.	261
Printing Area.	264
Printing Area.	265
Other Sizes than Letter or Legal.	266
Letter, Legal.	267
Sizes for 0.98 inch (25 mm) Margin Paper.	268
Appendix.	270
Safety.	271
Safety Precautions.	272
Regulatory Information.	273
Legal Restrictions on Printing.	286
Basic Printing Workflow.	287
Printing Photos from a Computer (Windows).	288
Printing Photos from a Computer (Mac OS).	292
Enhanced Printing Options.	296

Printing from Computer.	299
Printing from Application Software (Mac OS Printer Driver).	301
Printing with Easy Setup.	302
Paper Settings on the Printer Driver and the Printer (Media Type).	306
Paper Settings on the Printer Driver and the Printer (Paper Size).	308
Setting the Number of Copies and Printing Order.	309
Setting the Stapling Margin.	311
Execute Borderless Printing.	312
Scaling the Printing to Fit the Paper Size.	315
Scaled Printing.	317
Page Layout Printing.	318
Printing on Postcards.	320
Changing the Clear Coating Settings.	321
Switching the Paper Source to Match the Purpose.	323
Setting Paper Dimensions (Custom Size).	325
Changing the Print Quality and Correcting Image Data.	326
Setting the Print Quality Level (Custom).	327
Printing a Color Document in Monochrome.	328
Adjusting Tone.	329
Specifying Color Correction.	332
Optimal Photo Printing of Image Data.	334
Adjusting Colors with the Printer Driver.	335
Printing with ICC Profiles (Specifying an ICC Profile from the Application Software).	337
Printing with ICC Profiles (Specifying an ICC Profile from the Printer Driver).	339
Interpreting the ICC Profile.	340
Adjusting Color Balance.	341
Adjusting Brightness.	343
Adjusting Contrast.	345
Printing Using a Web Service.	347
Using PIXMA/MAXIFY Cloud Link.	43
Printing with Google Cloud Print.	349
Getting Google Account.	351
Registering Printer with Google Cloud Print.	352
Printing from Computer or Smartphone with Google Cloud Print.	355
Deleting Printer from Google Cloud Print.	359
Printing from an AirPrint-enabled Printer with Mac.	361
Printing from Smartphone/Tablet.	363
Printing Directly from Smartphone/Tablet.	364

Android Print.	365
Printing from an AirPrint-enabled Printer with iOS Device.	366
Using Printer with Direct Connection.	370
Printing Using a Web Service.	374
Using PIXMA/MAXIFY Cloud Link.	43
Printing with Google Cloud Print.	349
Printing Using Operation Panel.	378
Printing Templates Such as Lined or Graph Paper.	379
Printing from Digital Camera.	381
Printing Photographs Directly from PictBridge (Wireless LAN) Compliant Device.	382
PictBridge (Wireless LAN) Print Settings.	384
Windows Software.	386
Printing Using Canon Application Software.	387
My Image Garden Guide.	388
Print Studio Pro Guide.	389
Quick Utility Toolbox Guide.	392
Media Configuration Tool Guide.	393
Device Management Console Guide.	394
Accounting Manager Guide.	395
Mac OS Software.	396
Printer Driver.	397
Overview of the Printer Driver.	398
Canon IJ Printer Driver.	399
How to Open the Printer Driver Setup Window.	400
Page Setup Dialog.	401
Print Dialog.	402
Registering a Changed Printing Profile.	404
Quality & Media.	406
Color Options.	408
Paper Detailed Settings.	411
Page Processing.	413
Canon IJ Printer Utility2.	414
Opening the Canon IJ Printer Utility2.	415
Changing Printer Settings from Your Computer (Mac OS).	416
Managing the Printer Power.	417
Reducing the Printer Noise.	418

Changing the Printer Operation Mode.	420
Updating Media Information in Printer Driver.	421
Correcting Media Information in Printer Driver (When Printer Used in Shared Environment)	423
Setting Accounting information.	424
Maintenance of this Printer.	425
Display the Printing Status Screen.	426
Deleting the Undesired Print Job.	428
Instructions for Use (Printer Driver).	429
Updating the Printer Driver.	430
Obtaining the Latest Printer Driver.	431
Delete the Unnecessary Canon IJ Printer from the Printer List.	432
Before Installing the Printer Driver.	433
Installing the Printer Driver.	434
Sharing the Printer on a Network.	435
Settings on Print Server.	436
Settings on Client PC.	437
Restrictions on Printer Sharing.	438
Printing Using Canon Application Software.	439
My Image Garden Guide.	388
Print Studio Pro Guide.	389
Quick Utility Toolbox Guide.	392
Media Configuration Tool Guide.	393
Device Management Console Guide.	394
Accounting Manager Guide.	395
iOS Software.	448
Browse/Print Photo Items Using Pro Gallery Print.	40
Print Easily from a Smartphone or Tablet with Canon PRINT Inkjet/SELPHY.	106
Print Easily from a Smartphone or Tablet with Canon PRINT Inkjet/SELPHY.	106
Troubleshooting.	452
Power Does Not Come On.	454
Printing Does Not Start.	455
Paper Does Not Feed Properly/"No Paper" Error.	459
Print Results Are Unsatisfactory.	461
No Ink Comes Out.	463
Paper Jams.	464

An Error Occurs.	466
List of Support Code for Error.	468
Network Communication Problems.	470
Cannot Find Printer on Network.	471
Cannot Find Printer on Check Printer Settings Screen (Windows).	472
Check 1: Cannot Find Printer on Check Printer Settings Screen During Wireless LAN Setup (Windows).	473
Check 2: Cannot Find Printer on Check Printer Settings Screen During Wireless LAN Setup (Windows).	474
Check 3: Cannot Find Printer on Check Printer Settings Screen During Wireless LAN Setup (Windows).	475
Check 4: Cannot Find Printer on Check Printer Settings Screen During Wireless LAN Setup (Windows).	477
Check 5: Cannot Find Printer on Check Printer Settings Screen During Wireless LAN Setup (Windows).	478
Check 6: Cannot Find Printer on Check Printer Settings Screen During Wireless LAN Setup (Windows).	479
Check 1: Cannot Find Printer on Check Printer Settings Screen During Wired LAN Setup (Windows).	480
Check 2: Cannot Find Printer on Check Printer Settings Screen During Wired LAN Setup (Windows).	481
Check 3: Cannot Find Printer on Check Printer Settings Screen During Wired LAN Setup (Windows).	482
Check 4: Cannot Find Printer on Check Printer Settings Screen During Wired LAN Setup (Windows).	483
Check 5: Cannot Find Printer on Check Printer Settings Screen During Wired LAN Setup (Windows).	484
Check 6: Cannot Find Printer on Check Printer Settings Screen During Wired LAN Setup (Windows).	485
Check 7: Cannot Find Printer on Check Printer Settings Screen During Wired LAN Setup (Windows).	486
Cannot Find Printer on Select Printer Screen.	487
Searching Printer by IP Address or Host Name During Setup.	488
Cannot Proceed beyond Printer Connection Screen.	491
Cannot Find Printer while Using Wireless LAN.	493
Cannot Find Printer while Using Wired LAN.	495
Network Connection Problems.	496
Printer Suddenly Cannot Be Used.	497
Network Key Unknown.	501
Administrator Password Set for Printer Unknown.	503
Printer Cannot Be Used After Replacing Wireless Router or Changing Its Settings.	504

Printing Is Slow.	506
Cannot Access to Internet on Wireless LAN from Communication Device.	507
Ink Level Not Shown on Printer Status Monitor (Windows).	508
Other Network Problems.	509
Message Appears on Computer During Setup.	510
Checking Network Information.	512
Restoring to Factory Defaults.	515
Problems while Printing from Smartphone/Tablet.	516
Cannot Print from Smartphone/Tablet.	517
Printing Problems.	520
Printing Does Not Start.	455
Paper Jams.	464
Print Results Are Unsatisfactory.	461
Cannot Complete Printing.	529
Paper Is Blank/Printing Is Blurry/Colors Are Wrong/White Streaks Appear.	530
Lines Are Misaligned.	533
Lines Incomplete or Missing (Windows).	534
Images Incomplete or Missing (Windows).	535
Ink Blots / Paper Curl.	536
Paper Is Smudged / Printed Surface Is Scratched.	537
Back of Paper Is Smudged.	540
Vertical Line Next to Image.	541
Uneven or Streaked Colors.	542
Small Dots of Ink Adheres to Margins of Paper.	544
Printed Colors Are Inaccurate.	545
Documents Are Printed in Monochrome.	547
No Ink Comes Out.	463
Paper Does Not Feed Properly/"No Paper" Error.	459
Printing Stops.	551
Cannot Print Using AirPrint.	552
Paper Does Not Feed from Paper Source Specified in Printer Driver (Windows).	553
Mechanical Problems.	554
Power Does Not Come On.	454
Power Shuts Off By Itself.	556
USB Connection Problems.	557
Cannot Communicate with Printer via USB.	558
LCD Is Off.	559
LCD Shows Wrong Language.	560

Printer Status Monitor Not Displayed (Windows)	561
It Takes a Long Time for Printer to Warm Up/Printer Is Making an Operation Noise.	562
Installation and Download Problems.	563
Cannot Install Printer Driver.	564
Easy-WebPrint EX Does Not Start or Easy-WebPrint EX Menu Does Not Appear (Windows).	566
Updating Printer Driver in Network Environment (Windows).	567
Uninstalling IJ Network Device Setup Utility (Windows).	568
Errors and Messages.	569
An Error Occurs.	466
Message Appears.	572
Error Message Appears on PictBridge (Wireless LAN) Compliant Device.	578
Checking Error History on Operation Panel.	580
If You Cannot Solve a Problem.	581
List of Support Code for Error.	582
List of Support Code for Error (Paper Jams).	584
1300.	585
Paper Is Jammed inside Printer.	588
Other Cases.	591
1000.	592
1006.	593
1062.	594
1200.	595
1201.	596
1204.	597
1205.	598
1206.	599
1207.	600
1208.	601
1209.	602
1250.	603
1261.	604
1270.	605
1293.	606
1340.	607
1401.	608

1403.	609
1405.	610
1406.	611
1407.	612
1408.	613
1409.	614
140A.	615
140B.	616
140C.	617
140D.	618
140E.	619
140F.	620
1410.	621
1411.	622
1412.	623
1413.	624
1414.	625
1415.	626
1416.	627
1417.	628
1418.	629
1419.	630
141A.	631
141B.	632
1466.	633
1467.	634
1491.	635
1493.	636
1551.	637
1552.	638
1600.	639
1660.	640
1681.	641
1684.	642

1720.	643
1721.	644
1722.	645
1730.	646
1731.	647
1751.	648
1752.	649
1753.	650
1880.	651
1881.	652
1890.	653
2102.	654
2103.	655
2114.	656
2123.	659
2500.	660
2501.	661
2502.	662
2503.	663
3000.	664
3250.	665
3306.	666
3310.	667
3311.	668
3312.	669
3313.	670
3314.	671
3315.	672
3316.	673
3317.	674
3318.	675
3319.	676
3413.	677
4100.	678

4103.....	679
4109.....	680
4111.....	681
5100.....	682
5110.....	683
5200.....	684
5250.....	685
520A.....	686
520B.....	687
520C.....	688
520D.....	689
5400.....	690
5403.....	691
5700.....	692
5701.....	693
5B16.....	694
5C00.....	695
5C01.....	696
5C10.....	697
5C11.....	698
5C12.....	699
5C13.....	700
5C14.....	701
5C20.....	702
6000.....	703
6500.....	704
6502.....	705
6700.....	706
6701.....	707
6800.....	708
6801.....	709
6900.....	710
6901.....	711
6902.....	712

6910.....	713
6911.....	714
6920.....	715
6921.....	716
6930.....	717
6931.....	718
6932.....	719
6933.....	720
6940.....	721
6941.....	722
6942.....	723
6943.....	724
6944.....	725
6945.....	726
6946.....	727
6F00.....	728
7400.....	729
7401.....	730
7402.....	731
8100.....	732
8200.....	733
B202.....	734
B203.....	735
B204.....	736
B205.....	737
B206.....	738
B207.....	739
B208.....	740
B209.....	741
B400.....	742
B505.....	743
B506.....	744
B507.....	745
B600.....	746

B801..... 747
B802..... 748

Using This Online Manual

- [Symbols Used in This Document](#)
- [Touch-enabled Device Users \(Windows\)](#)

Symbols Used in This Document

Warning

Instructions that, if ignored, could result in death or serious personal injury caused by incorrect operation of the equipment. These must be observed for safe operation.

Caution

Instructions that, if ignored, could result in personal injury or material damage caused by incorrect operation of the equipment. These must be observed for safe operation.

Important

Instructions including important information. To avoid damage and injury or improper use of the product, be sure to read these indications.

Note

Instructions including notes for operation and additional explanations.

Basics

Instructions explaining basic operations of your product.

Note

- Icons may vary depending on your product.

Touch-enabled Device Users (Windows)

For touch actions, you need to replace "right-click" in this document with the action set on the operating system. For example, if the action is set to "press and hold" on your operating system, replace "right-click" with "press and hold."

Trademarks and Licenses

- Microsoft is a registered trademark of Microsoft Corporation.
- Windows is a trademark or registered trademark of Microsoft Corporation in the U.S. and/or other countries.
- Windows Vista is a trademark or registered trademark of Microsoft Corporation in the U.S. and/or other countries.
- Internet Explorer is a trademark or registered trademark of Microsoft Corporation in the U.S. and/or other countries.
- Mac, Mac OS, AirPort, Safari, Bonjour, iPad, iPhone and iPod touch are trademarks of Apple Inc., registered in the U.S. and other countries. App Store, AirPrint and the AirPrint logo are trademarks of Apple Inc.
- IOS is a trademark or registered trademark of Cisco in the U.S. and other countries and is used under license.
- Google Cloud Print, Google Chrome, Chrome OS, Chromebook, Android, Google Play and Picasa are either registered trademarks or trademarks of Google Inc.
- Adobe, Flash, Photoshop, Photoshop Elements, Lightroom, Adobe RGB and Adobe RGB (1998) are either registered trademarks or trademarks of Adobe Systems Incorporated in the United States and/or other countries.
- Bluetooth is a trademark of Bluetooth SIG, Inc., U.S.A. and licensed to Canon Inc.

Note

- The formal name of Windows Vista is Microsoft Windows Vista operating system.

Copyright (c) 2003-2004, Apple Computer, Inc. All rights reserved.

Redistribution and use in source and binary forms, with or without modification, are permitted provided that the following conditions are met:

1. Redistributions of source code must retain the above copyright notice, this list of conditions and the following disclaimer.
2. Redistributions in binary form must reproduce the above copyright notice, this list of conditions and the following disclaimer in the documentation and/or other materials provided with the distribution.
3. Neither the name of Apple Computer, Inc. ("Apple") nor the names of its contributors may be used to endorse or promote products derived from this software without specific prior written permission.

THIS SOFTWARE IS PROVIDED BY APPLE AND ITS CONTRIBUTORS "AS IS" AND ANY EXPRESS OR IMPLIED WARRANTIES, INCLUDING, BUT NOT LIMITED TO, THE IMPLIED WARRANTIES OF MERCHANTABILITY AND FITNESS FOR A PARTICULAR PURPOSE ARE DISCLAIMED. IN NO EVENT SHALL APPLE OR ITS CONTRIBUTORS BE LIABLE FOR ANY DIRECT, INDIRECT, INCIDENTAL, SPECIAL, EXEMPLARY, OR CONSEQUENTIAL DAMAGES (INCLUDING, BUT NOT LIMITED TO, PROCUREMENT OF SUBSTITUTE GOODS OR SERVICES; LOSS OF USE, DATA, OR PROFITS; OR BUSINESS INTERRUPTION) HOWEVER CAUSED AND ON ANY THEORY OF LIABILITY, WHETHER IN CONTRACT, STRICT LIABILITY, OR TORT INCLUDING NEGLIGENCE OR OTHERWISE) ARISING IN ANY WAY OUT OF THE USE OF THIS SOFTWARE, EVEN IF ADVISED OF THE POSSIBILITY OF SUCH DAMAGE.

Apache License

Version 2.0, January 2004

<http://www.apache.org/licenses/>

TERMS AND CONDITIONS FOR USE, REPRODUCTION, AND DISTRIBUTION

1. Definitions.

"License" shall mean the terms and conditions for use, reproduction, and distribution as defined by Sections 1 through 9 of this document.

"Licensor" shall mean the copyright owner or entity authorized by the copyright owner that is granting the License.

"Legal Entity" shall mean the union of the acting entity and all other entities that control, are controlled by, or are under common control with that entity. For the purposes of this definition, "control" means (i) the power, direct or indirect, to cause the direction or management of such entity, whether by contract or otherwise, or (ii) ownership of fifty percent (50%) or more of the outstanding shares, or (iii) beneficial ownership of such entity.

"You" (or "Your") shall mean an individual or Legal Entity exercising permissions granted by this License.

"Source" form shall mean the preferred form for making modifications, including but not limited to software source code, documentation source, and configuration files.

"Object" form shall mean any form resulting from mechanical transformation or translation of a Source form, including but not limited to compiled object code, generated documentation, and conversions to other media types.

"Work" shall mean the work of authorship, whether in Source or Object form, made available under the License, as indicated by a copyright notice that is included in or attached to the work (an example is provided in the Appendix below).

"Derivative Works" shall mean any work, whether in Source or Object form, that is based on (or derived from) the Work and for which the editorial revisions, annotations, elaborations, or other modifications represent, as a whole, an original work of authorship. For the purposes of this License, Derivative Works shall not include works that remain separable from, or merely link (or bind by name) to the interfaces of, the Work and Derivative Works thereof.

"Contribution" shall mean any work of authorship, including the original version of the Work and any modifications or additions to that Work or Derivative Works thereof, that is intentionally submitted to Licensor for inclusion in the Work by the copyright owner or by an individual or Legal Entity authorized to submit on behalf of the copyright owner. For the purposes of this definition, "submitted" means any form of electronic, verbal, or written communication sent to the Licensor or its representatives, including but not limited to communication on electronic mailing lists, source code control systems, and issue tracking systems that are managed by, or on behalf of, the Licensor for the purpose of discussing and improving the Work, but excluding communication that is conspicuously marked or otherwise designated in writing by the copyright owner as "Not a Contribution."

"Contributor" shall mean Licensor and any individual or Legal Entity on behalf of whom a Contribution has been received by Licensor and subsequently incorporated within the Work.

2. Grant of Copyright License. Subject to the terms and conditions of this License, each Contributor hereby grants to You a perpetual, worldwide, non-exclusive, no-charge, royalty-free, irrevocable copyright license to reproduce, prepare Derivative Works of, publicly display, publicly perform, sublicense, and distribute the Work and such Derivative Works in Source or Object form.
3. Grant of Patent License. Subject to the terms and conditions of this License, each Contributor hereby grants to You a perpetual, worldwide, non-exclusive, no-charge, royalty-free, irrevocable (except as stated in this section) patent license to make, have made, use, offer to sell, sell, import, and otherwise transfer the Work, where such license applies only to those patent claims licensable by such Contributor that are necessarily infringed by their Contribution(s) alone or by combination of their Contribution(s) with the Work to which such Contribution(s) was submitted. If You institute patent

litigation against any entity (including a cross-claim or counterclaim in a lawsuit) alleging that the Work or a Contribution incorporated within the Work constitutes direct or contributory patent infringement, then any patent licenses granted to You under this License for that Work shall terminate as of the date such litigation is filed.

4. Redistribution. You may reproduce and distribute copies of the Work or Derivative Works thereof in any medium, with or without modifications, and in Source or Object form, provided that You meet the following conditions:
 1. You must give any other recipients of the Work or Derivative Works a copy of this License; and
 2. You must cause any modified files to carry prominent notices stating that You changed the files; and
 3. You must retain, in the Source form of any Derivative Works that You distribute, all copyright, patent, trademark, and attribution notices from the Source form of the Work, excluding those notices that do not pertain to any part of the Derivative Works; and
 4. If the Work includes a "NOTICE" text file as part of its distribution, then any Derivative Works that You distribute must include a readable copy of the attribution notices contained within such NOTICE file, excluding those notices that do not pertain to any part of the Derivative Works, in at least one of the following places: within a NOTICE text file distributed as part of the Derivative Works; within the Source form or documentation, if provided along with the Derivative Works; or, within a display generated by the Derivative Works, if and wherever such third-party notices normally appear. The contents of the NOTICE file are for informational purposes only and do not modify the License. You may add Your own attribution notices within Derivative Works that You distribute, alongside or as an addendum to the NOTICE text from the Work, provided that such additional attribution notices cannot be construed as modifying the License.

You may add Your own copyright statement to Your modifications and may provide additional or different license terms and conditions for use, reproduction, or distribution of Your modifications, or for any such Derivative Works as a whole, provided Your use, reproduction, and distribution of the Work otherwise complies with the conditions stated in this License.

5. Submission of Contributions. Unless You explicitly state otherwise, any Contribution intentionally submitted for inclusion in the Work by You to the Licensor shall be under the terms and conditions of this License, without any additional terms or conditions. Notwithstanding the above, nothing herein shall supersede or modify the terms of any separate license agreement you may have executed with Licensor regarding such Contributions.
6. Trademarks. This License does not grant permission to use the trade names, trademarks, service marks, or product names of the Licensor, except as required for reasonable and customary use in describing the origin of the Work and reproducing the content of the NOTICE file.
7. Disclaimer of Warranty. Unless required by applicable law or agreed to in writing, Licensor provides the Work (and each Contributor provides its Contributions) on an "AS IS" BASIS, WITHOUT WARRANTIES OR CONDITIONS OF ANY KIND, either express or implied, including, without limitation, any warranties or conditions of TITLE, NON-INFRINGEMENT, MERCHANTABILITY, or FITNESS FOR A PARTICULAR PURPOSE. You are solely responsible for determining the appropriateness of using or redistributing the Work and assume any risks associated with Your exercise of permissions under this License.
8. Limitation of Liability. In no event and under no legal theory, whether in tort (including negligence), contract, or otherwise, unless required by applicable law (such as deliberate and grossly negligent acts) or agreed to in writing, shall any Contributor be liable to You for damages, including any direct, indirect, special, incidental, or consequential damages of any character arising as a result of this License or out of the use or inability to use the Work (including but not limited to damages for loss of goodwill, work stoppage, computer failure or malfunction, or any and all other commercial damages or losses), even if such Contributor has been advised of the possibility of such damages.

9. Accepting Warranty or Additional Liability. While redistributing the Work or Derivative Works thereof, You may choose to offer, and charge a fee for, acceptance of support, warranty, indemnity, or other liability obligations and/or rights consistent with this License. However, in accepting such obligations, You may act only on Your own behalf and on Your sole responsibility, not on behalf of any other Contributor, and only if You agree to indemnify, defend, and hold each Contributor harmless for any liability incurred by, or claims asserted against, such Contributor by reason of your accepting any such warranty or additional liability.

END OF TERMS AND CONDITIONS

---- Part 1: CMU/UCD copyright notice: (BSD like) ----

Copyright 1989, 1991, 1992 by Carnegie Mellon University

Derivative Work - 1996, 1998-2000

Copyright 1996, 1998-2000 The Regents of the University of California

All Rights Reserved

Permission to use, copy, modify and distribute this software and its documentation for any purpose and without fee is hereby granted, provided that the above copyright notice appears in all copies and that both that copyright notice and this permission notice appear in supporting documentation, and that the name of CMU and The Regents of the University of California not be used in advertising or publicity pertaining to distribution of the software without specific written permission.

CMU AND THE REGENTS OF THE UNIVERSITY OF CALIFORNIA DISCLAIM ALL WARRANTIES WITH REGARD TO THIS SOFTWARE, INCLUDING ALL IMPLIED WARRANTIES OF MERCHANTABILITY AND FITNESS. IN NO EVENT SHALL CMU OR THE REGENTS OF THE UNIVERSITY OF CALIFORNIA BE LIABLE FOR ANY SPECIAL, INDIRECT OR CONSEQUENTIAL DAMAGES OR ANY DAMAGES WHATSOEVER RESULTING FROM THE LOSS OF USE, DATA OR PROFITS, WHETHER IN AN ACTION OF CONTRACT, NEGLIGENCE OR OTHER TORTIOUS ACTION, ARISING OUT OF OR IN CONNECTION WITH THE USE OR PERFORMANCE OF THIS SOFTWARE.

---- Part 2: Networks Associates Technology, Inc copyright notice (BSD) ----

Copyright (c) 2001-2003, Networks Associates Technology, Inc

All rights reserved.

Redistribution and use in source and binary forms, with or without modification, are permitted provided that the following conditions are met:

- * Redistributions of source code must retain the above copyright notice, this list of conditions and the following disclaimer.
- * Redistributions in binary form must reproduce the above copyright notice, this list of conditions and the following disclaimer in the documentation and/or other materials provided with the distribution.
- * Neither the name of the Networks Associates Technology, Inc nor the names of its contributors may be used to endorse or promote products derived from this software without specific prior written permission.

THIS SOFTWARE IS PROVIDED BY THE COPYRIGHT HOLDERS AND CONTRIBUTORS "AS IS" AND ANY EXPRESS OR IMPLIED WARRANTIES, INCLUDING, BUT NOT LIMITED TO, THE IMPLIED WARRANTIES OF MERCHANTABILITY AND FITNESS FOR A PARTICULAR PURPOSE ARE DISCLAIMED. IN NO EVENT SHALL THE COPYRIGHT HOLDERS OR CONTRIBUTORS BE LIABLE FOR ANY DIRECT, INDIRECT, INCIDENTAL, SPECIAL, EXEMPLARY, OR CONSEQUENTIAL DAMAGES (INCLUDING, BUT NOT LIMITED TO, PROCUREMENT OF SUBSTITUTE GOODS OR SERVICES; LOSS OF USE, DATA, OR PROFITS; OR BUSINESS INTERRUPTION) HOWEVER CAUSED AND ON ANY THEORY OF LIABILITY, WHETHER IN CONTRACT, STRICT LIABILITY, OR

TORT (INCLUDING NEGLIGENCE OR OTHERWISE) ARISING IN ANY WAY OUT OF THE USE OF THIS SOFTWARE, EVEN IF ADVISED OF THE POSSIBILITY OF SUCH DAMAGE.

---- Part 3: Cambridge Broadband Ltd. copyright notice (BSD) ----

Portions of this code are copyright (c) 2001-2003, Cambridge Broadband Ltd.

All rights reserved.

Redistribution and use in source and binary forms, with or without modification, are permitted provided that the following conditions are met:

- * Redistributions of source code must retain the above copyright notice, this list of conditions and the following disclaimer.
- * Redistributions in binary form must reproduce the above copyright notice, this list of conditions and the following disclaimer in the documentation and/or other materials provided with the distribution.
- * The name of Cambridge Broadband Ltd. may not be used to endorse or promote products derived from this software without specific prior written permission.

THIS SOFTWARE IS PROVIDED BY THE COPYRIGHT HOLDER ``AS IS" AND ANY EXPRESS OR IMPLIED WARRANTIES, INCLUDING, BUT NOT LIMITED TO, THE IMPLIED WARRANTIES OF MERCHANTABILITY AND FITNESS FOR A PARTICULAR PURPOSE ARE DISCLAIMED. IN NO EVENT SHALL THE COPYRIGHT HOLDER BE LIABLE FOR ANY DIRECT, INDIRECT, INCIDENTAL, SPECIAL, EXEMPLARY, OR CONSEQUENTIAL DAMAGES (INCLUDING, BUT NOT LIMITED TO, PROCUREMENT OF SUBSTITUTE GOODS OR SERVICES; LOSS OF USE, DATA, OR PROFITS; OR BUSINESS INTERRUPTION) HOWEVER CAUSED AND ON ANY THEORY OF LIABILITY, WHETHER IN CONTRACT, STRICT LIABILITY, OR TORT (INCLUDING NEGLIGENCE OR OTHERWISE) ARISING IN ANY WAY OUT OF THE USE OF THIS SOFTWARE, EVEN IF ADVISED OF THE POSSIBILITY OF SUCH DAMAGE.

---- Part 4: Sun Microsystems, Inc. copyright notice (BSD) ----

Copyright c 2003 Sun Microsystems, Inc., 4150 Network Circle, Santa Clara, California 95054, U.S.A. All rights reserved.

Use is subject to license terms below.

This distribution may include materials developed by third parties.

Sun, Sun Microsystems, the Sun logo and Solaris are trademarks or registered trademarks of Sun Microsystems, Inc. in the U.S. and other countries.

Redistribution and use in source and binary forms, with or without modification, are permitted provided that the following conditions are met:

- * Redistributions of source code must retain the above copyright notice, this list of conditions and the following disclaimer.
- * Redistributions in binary form must reproduce the above copyright notice, this list of conditions and the following disclaimer in the documentation and/or other materials provided with the distribution.
- * Neither the name of the Sun Microsystems, Inc. nor the names of its contributors may be used to endorse or promote products derived from this software without specific prior written permission.

THIS SOFTWARE IS PROVIDED BY THE COPYRIGHT HOLDERS AND CONTRIBUTORS ``AS IS" AND ANY EXPRESS OR IMPLIED WARRANTIES, INCLUDING, BUT NOT LIMITED TO, THE IMPLIED WARRANTIES OF MERCHANTABILITY AND FITNESS FOR A PARTICULAR PURPOSE ARE DISCLAIMED. IN NO EVENT SHALL THE COPYRIGHT HOLDERS OR CONTRIBUTORS BE LIABLE FOR ANY DIRECT, INDIRECT, INCIDENTAL, SPECIAL, EXEMPLARY, OR CONSEQUENTIAL

DAMAGES (INCLUDING, BUT NOT LIMITED TO, PROCUREMENT OF SUBSTITUTE GOODS OR SERVICES; LOSS OF USE, DATA, OR PROFITS; OR BUSINESS INTERRUPTION) HOWEVER CAUSED AND ON ANY THEORY OF LIABILITY, WHETHER IN CONTRACT, STRICT LIABILITY, OR TORT (INCLUDING NEGLIGENCE OR OTHERWISE) ARISING IN ANY WAY OUT OF THE USE OF THIS SOFTWARE, EVEN IF ADVISED OF THE POSSIBILITY OF SUCH DAMAGE.

---- Part 5: Sparta, Inc copyright notice (BSD) ----

Copyright (c) 2003-2009, Sparta, Inc

All rights reserved.

Redistribution and use in source and binary forms, with or without modification, are permitted provided that the following conditions are met:

- * Redistributions of source code must retain the above copyright notice, this list of conditions and the following disclaimer.
- * Redistributions in binary form must reproduce the above copyright notice, this list of conditions and the following disclaimer in the documentation and/or other materials provided with the distribution.
- * Neither the name of Sparta, Inc nor the names of its contributors may be used to endorse or promote products derived from this software without specific prior written permission.

THIS SOFTWARE IS PROVIDED BY THE COPYRIGHT HOLDERS AND CONTRIBUTORS ``AS IS'' AND ANY EXPRESS OR IMPLIED WARRANTIES, INCLUDING, BUT NOT LIMITED TO, THE IMPLIED WARRANTIES OF MERCHANTABILITY AND FITNESS FOR A PARTICULAR PURPOSE ARE DISCLAIMED. IN NO EVENT SHALL THE COPYRIGHT HOLDERS OR CONTRIBUTORS BE LIABLE FOR ANY DIRECT, INDIRECT, INCIDENTAL, SPECIAL, EXEMPLARY, OR CONSEQUENTIAL DAMAGES (INCLUDING, BUT NOT LIMITED TO, PROCUREMENT OF SUBSTITUTE GOODS OR SERVICES; LOSS OF USE, DATA, OR PROFITS; OR BUSINESS INTERRUPTION) HOWEVER CAUSED AND ON ANY THEORY OF LIABILITY, WHETHER IN CONTRACT, STRICT LIABILITY, OR TORT (INCLUDING NEGLIGENCE OR OTHERWISE) ARISING IN ANY WAY OUT OF THE USE OF THIS SOFTWARE, EVEN IF ADVISED OF THE POSSIBILITY OF SUCH DAMAGE.

---- Part 6: Cisco/BUPTNIC copyright notice (BSD) ----

Copyright (c) 2004, Cisco, Inc and Information Network Center of Beijing University of Posts and Telecommunications.

All rights reserved.

Redistribution and use in source and binary forms, with or without modification, are permitted provided that the following conditions are met:

- * Redistributions of source code must retain the above copyright notice, this list of conditions and the following disclaimer.
- * Redistributions in binary form must reproduce the above copyright notice, this list of conditions and the following disclaimer in the documentation and/or other materials provided with the distribution.
- * Neither the name of Cisco, Inc, Beijing University of Posts and Telecommunications, nor the names of their contributors may be used to endorse or promote products derived from this software without specific prior written permission.

THIS SOFTWARE IS PROVIDED BY THE COPYRIGHT HOLDERS AND CONTRIBUTORS ``AS IS'' AND ANY EXPRESS OR IMPLIED WARRANTIES, INCLUDING, BUT NOT LIMITED TO, THE IMPLIED WARRANTIES OF MERCHANTABILITY AND FITNESS FOR A PARTICULAR PURPOSE ARE DISCLAIMED. IN NO EVENT SHALL THE COPYRIGHT HOLDERS OR CONTRIBUTORS BE LIABLE FOR ANY DIRECT, INDIRECT, INCIDENTAL, SPECIAL, EXEMPLARY, OR CONSEQUENTIAL

DAMAGES (INCLUDING, BUT NOT LIMITED TO, PROCUREMENT OF SUBSTITUTE GOODS OR SERVICES; LOSS OF USE, DATA, OR PROFITS; OR BUSINESS INTERRUPTION) HOWEVER CAUSED AND ON ANY THEORY OF LIABILITY, WHETHER IN CONTRACT, STRICT LIABILITY, OR TORT (INCLUDING NEGLIGENCE OR OTHERWISE) ARISING IN ANY WAY OUT OF THE USE OF THIS SOFTWARE, EVEN IF ADVISED OF THE POSSIBILITY OF SUCH DAMAGE.

---- Part 7: Fabasoft R&D Software GmbH & Co KG copyright notice (BSD) ----

Copyright (c) Fabasoft R&D Software GmbH & Co KG, 2003 oss@fabasoft.com

Author: Bernhard Penz

Redistribution and use in source and binary forms, with or without modification, are permitted provided that the following conditions are met:

* Redistributions of source code must retain the above copyright notice, this list of conditions and the following disclaimer.

* Redistributions in binary form must reproduce the above copyright notice, this list of conditions and the following disclaimer in the documentation and/or other materials provided with the distribution.

* The name of Fabasoft R&D Software GmbH & Co KG or any of its subsidiaries, brand or product names may not be used to endorse or promote products derived from this software without specific prior written permission.

THIS SOFTWARE IS PROVIDED BY THE COPYRIGHT HOLDER ``AS IS" AND ANY EXPRESS OR IMPLIED WARRANTIES, INCLUDING, BUT NOT LIMITED TO, THE IMPLIED WARRANTIES OF MERCHANTABILITY AND FITNESS FOR A PARTICULAR PURPOSE ARE DISCLAIMED. IN NO EVENT SHALL THE COPYRIGHT HOLDER BE LIABLE FOR ANY DIRECT, INDIRECT, INCIDENTAL, SPECIAL, EXEMPLARY, OR CONSEQUENTIAL DAMAGES (INCLUDING, BUT NOT LIMITED TO, PROCUREMENT OF SUBSTITUTE GOODS OR SERVICES; LOSS OF USE, DATA, OR PROFITS; OR BUSINESS INTERRUPTION) HOWEVER CAUSED AND ON ANY THEORY OF LIABILITY, WHETHER IN CONTRACT, STRICT LIABILITY, OR TORT (INCLUDING NEGLIGENCE OR OTHERWISE) ARISING IN ANY WAY OUT OF THE USE OF THIS SOFTWARE, EVEN IF ADVISED OF THE POSSIBILITY OF SUCH DAMAGE.

The following applies only to products supporting Wi-Fi.

(c) 2009-2013 by Jeff Mott. All rights reserved.

Redistribution and use in source and binary forms, with or without modification, are permitted provided that the following conditions are met:

* Redistributions of source code must retain the above copyright notice, this list of conditions, and the following disclaimer.

* Redistributions in binary form must reproduce the above copyright notice, this list of conditions, and the following disclaimer in the documentation or other materials provided with the distribution.

* Neither the name CryptoJS nor the names of its contributors may be used to endorse or promote products derived from this software without specific prior written permission.

THIS SOFTWARE IS PROVIDED BY THE COPYRIGHT HOLDERS AND CONTRIBUTORS "AS IS," AND ANY EXPRESS OR IMPLIED WARRANTIES, INCLUDING, BUT NOT LIMITED TO, THE IMPLIED WARRANTIES OF MERCHANTABILITY AND FITNESS FOR A PARTICULAR PURPOSE, ARE DISCLAIMED. IN NO EVENT SHALL THE COPYRIGHT HOLDER OR CONTRIBUTORS BE LIABLE FOR ANY DIRECT, INDIRECT, INCIDENTAL, SPECIAL, EXEMPLARY, OR CONSEQUENTIAL DAMAGES (INCLUDING, BUT NOT LIMITED TO, PROCUREMENT OF SUBSTITUTE GOODS OR SERVICES; LOSS OF USE, DATA, OR PROFITS; OR BUSINESS INTERRUPTION) HOWEVER

CAUSED AND ON ANY THEORY OF LIABILITY, WHETHER IN CONTRACT, STRICT LIABILITY, OR TORT (INCLUDING NEGLIGENCE OR OTHERWISE) ARISING IN ANY WAY OUT OF THE USE OF THIS SOFTWARE, EVEN IF ADVISED OF THE POSSIBILITY OF SUCH DAMAGE.

Enter keywords in the search window and click  (Search).

You can search for target pages in this guide.

Entry example: "(your product's model name) load paper"

Search Tips

You can search for target pages by entering keywords in the search window.

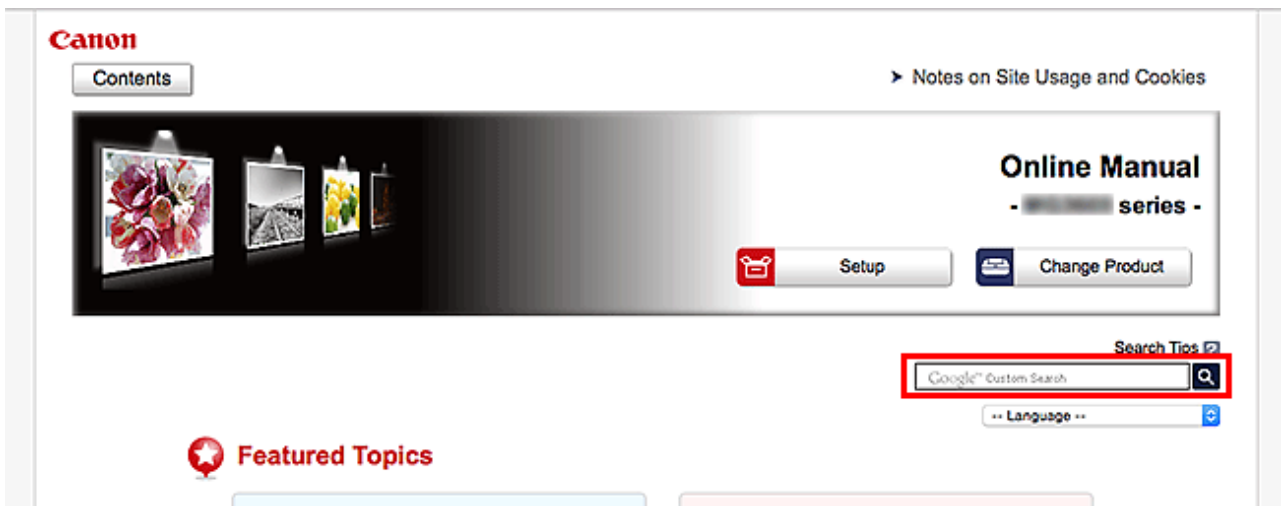

►► Important

- This function may not be available in some countries/regions.

►► Note

- The displayed screen may vary.
- When searching from this page without entering your product's model name or your application's name, all products supported by this guide will be considered for the search.
If you want to narrow down the search results, add your product's model name or your application's name to the keywords.

• Searching for Functions

Enter your product's model name and a keyword for the function you want to learn about

Example: When you want to learn how to load paper

Enter "(your product's model name) load paper" in the search window and perform a search

• Troubleshooting Errors

Enter your product's model name and a support code

Example: When the following error screen appears

Enter "(your product's model name) 1003" in the search window and perform a search

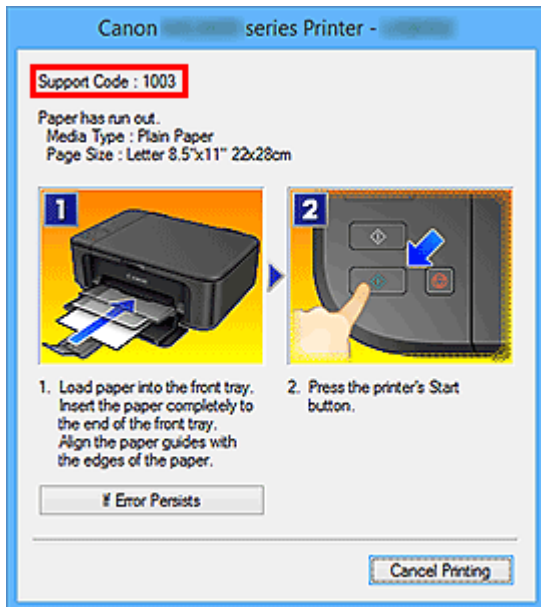

►►► Note

- The displayed screen varies depending on your product.

• Searching for Application Functions

Enter your application's name and a keyword for the function you want to learn about

Example: When you want to learn how to print collages with My Image Garden

Enter "My Image Garden collage" in the search window and perform a search

• Searching for Reference Pages

Enter your model name and a reference page title*

* You can find reference pages more easily by entering the function name as well.

Example: When you want to browse the page referred to by the following sentence on a scanning procedure page

Refer to "Color Settings Tab" for your model from Home of the *Online Manual* for details.

Enter "(your product's model name) scan Color Settings Tab" in the search window and perform a search

Printer Functions

- ▶ **Connect Wirelessly with Ease in "Direct Connection"**
- ▶ **Print Photos Easily Using My Image Garden**
- ▶ **Download a Variety of Content Materials**
- ▶ **Print Items with Easy-PhotoPrint+ (Web Application)**
- ▶ **Managing Printer Conveniently Using Quick Utility Toolbox**
- ▶ **Available Connection Methods**
- ▶ **Print Professional Photos Using Print Studio Pro**
- ▶ **Browse/Print Photo Items Using Pro Gallery Print**
- ▶ **Managing Paper Information on Printer Using Media Configuration Tool**
- ▶ **Managing Printer Status Using Device Management Console**
- ▶ **Using PIXMA/MAXIFY Cloud Link**
- ▶ **Print Easily from a Smartphone or Tablet with Canon PRINT Inkjet/SELPHY**
- ▶ **Printing with Windows RT**

Connect Wirelessly with Ease in "Direct Connection"

The printer supports "direct connection" in which you can connect to the printer wirelessly from a computer or smartphone even in an environment without a wireless router.

Switch to "direct connection" with simple steps to enjoy printing wirelessly.

■ [Using Printer with Direct Connection](#)



Print Photos Easily Using My Image Garden

Organize Images Easily

In My Image Garden, you can register the names of people and events to photos. You can organize photos easily as you can display them not only by folder but also by calendar, event, and person. This also allows you to find the target photos easily when you search for them later on.

<Calendar View>



<People View>

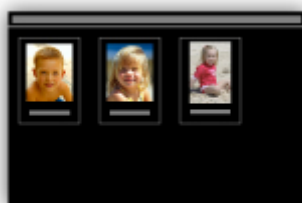

Printing Photos Easily

Print your favorite photos easily in the following three steps.

1. Select image you want to print.
2. Select layout and paper size.
3. Click Print.



Place Photos Automatically

Delightful items are created easily as the selected photos are placed automatically according to the theme.



Other Various Functions

My Image Garden has many other useful functions.

Refer to the following for details.

- What You Can Do with My Image Garden (Windows)
- What You Can Do with My Image Garden (Mac OS)

Download a Variety of Content Materials

CREATIVE PARK

A "printing materials site" where you can download all the printing materials for free.

Various types of content such as seasonal cards and paper crafts that can be made by assembling paper parts are provided.

CREATIVE PARK PREMIUM

A service where customers using models that support PREMIUM Contents can download exclusive printing materials.

PREMIUM Contents can be downloaded easily via My Image Garden or Easy-PhotoPrint+. Downloaded PREMIUM Contents can be printed directly with My Image Garden or Easy-PhotoPrint+.

To download PREMIUM Contents, make sure that genuine Canon ink tanks/ink cartridges are installed for all colors on a supported printer.



►► Note

- The designs of PREMIUM Contents provided in this page are subject to change without prior notice.

Print Items with Easy-PhotoPrint+ (Web Application)

You can easily create and print personalized items such as calendars and collages, anytime and anywhere, by simply accessing Easy-PhotoPrint+ on the web from a computer or tablet.

By using Easy-PhotoPrint+, you can create items in the latest environment without going through the trouble of installation.

Moreover, you can use various photos for your item through integration with social networks such as Facebook, or with online storage, web albums, etc.

Refer to "Easy-PhotoPrint+ Guide" for details.



Managing Printer Conveniently Using Quick Utility Toolbox

Quick Utility Toolbox is a shortcut menu that lets you access the functions you want to use with one click. After installing utilities compatible with Quick Utility Toolbox, they will be added to this menu. The Quick Utility Toolbox provides a convenient way to quickly launch added utilities for making printer settings and doing other management tasks.

Refer to the following for details.

- [Quick Utility Toolbox Guide \(Windows\)](#)
- [Quick Utility Toolbox Guide \(Mac OS\)](#)



Available Connection Methods

The following connection methods are available on the printer.

Wireless Connection

- With a wireless router



- Without a wireless router



Wired Connection



USB Connection



Wireless Connection

There are two methods for connecting the printer to your device (such as a smartphone). One method is to connect using a wireless router, and the other method is to connect without using a wireless router.

The two connection methods cannot be used at the same time.

If you have a wireless router, we recommend you use the method described in Connection Using a Wireless Router.

When connecting another device while a device is already connected to the printer, connect it using the same connection method as the connected device.

If you connect using a different connection method, the connection to the device in use will be disabled.

• Connection Using a Wireless Router



- Connect the printer and a device using a wireless router.
- Connection methods vary depending on the wireless router type.
- You can change network settings such as the SSID and security protocol on the printer.
- When the connection between a device and a wireless router is completed and  (Wi-Fi icon) is displayed in the device's screen, you can connect the device to the printer using the wireless router.

• Connection without Using a Wireless Router



- Connect the printer and a device without using a wireless router. Connect a device and the printer directly using the printer's direct connection.
- When establishing a connection in the direct connection, Internet connection may become unavailable. In that case, web services for the printer cannot be used.
- If you connect a device connected to the Internet via a wireless router to the printer that is in the direct connection, the connection between the device and wireless router will be disabled. In that case, the connection of the device may switch to a mobile data connection automatically depending on your device. Transmission fees for connecting to the Internet using a mobile data connection apply.
- In the direct connection, you can connect up to five devices at the same time. If you try to connect a sixth device while five devices are already connected, an error will appear. If an error appears, disconnect a device you do not use and configure settings again.
- Network settings such as the SSID and security protocol are specified automatically.

Wired Connection

Connect the printer and a hub or router with an Ethernet cable. Prepare an Ethernet cable.

USB Connection

Connect the printer and a computer with a USB cable. Prepare a USB cable.

Restrictions

(Appears in a new window)

Restrictions

When connecting another device while a device (such as a smartphone) is already connected to the printer, connect it using the same connection method as the connected device.

If you connect using a different connection method, the connection to the device in use will be disabled.

Connection Using a Wired Network cannot be performed on printers that do not support a wired connection.

Connect via wireless router

- You cannot establish a printer with wireless and wired connections at the same time.
- Make sure your device and the wireless router are connected. For details on checking these settings, see the manual supplied with the wireless router or contact its manufacturer.
As for a device already connected to the printer without using a wireless router, reconnect it via a wireless router.
- Configuration, router functions, setup procedures and security settings of network devices vary depending on the system environment. For details, see the manual for your network device or contact its manufacturer.
- Check if your device supports IEEE802.11n (2.4 GHz), IEEE802.11g or IEEE802.11b.
- If your device is set to the "IEEE802.11n only" mode, WEP or TKIP cannot be used as a security protocol. Change the security protocol for your device to something other than WEP and TKIP or change the setting to something other than "IEEE802.11n only."
The connection between your device and the wireless router will be temporarily disabled while the setting is changed. Do not proceed to the next screen of this guide until setup is complete.
- For office use, consult your network administrator.
- Note that if you connect to a network with no security protection, your personal information could be disclosed to a third party.

Direct Connection

►► Important

- If a device is connected to the Internet via a wireless router, and you then connect it to a printer in Direct Connection mode, the existing connection between the device and wireless router will be disabled. In that case, the connection of the device may switch to a mobile data connection automatically depending on your device. When you connect to the Internet using a mobile data connection, charges may apply depending on your contract.
 - When you connect a device and the printer using Direct Connection, the connection information will be saved to Wi-Fi settings. The device may be connected to the printer automatically even after disconnecting it or connecting it to another wireless router.
 - You cannot connect to a wireless router and a printer in Direct Connection mode at the same time. If you have a wireless router, it is recommended that you use the wireless router to connect to the printer.
 - To prevent automatic connection to the printer in Direct Connection mode, change the connection mode after using the printer, or set not to connect automatically in the Wi-Fi settings of the device.
For details on checking or changing wireless router settings, see the wireless router manual or contact its manufacturer.
- If you connect a device and the printer using Direct Connection, Internet connection may become unavailable depending on your environment. In that case, web services for the printer cannot be used.

- In Direct Connection mode, you can connect up to five devices at the same time. If you try to connect a sixth device while five devices are already connected, an error will appear.
If an error appears, disconnect a device that does not use the printer, then configure settings again.
- Devices connected to the printer using Direct Connection cannot communicate with each other.
- Firmware updates for the printer are not available while using Direct Connection.
- When a device has been connected to the printer without using a wireless router and you want to set it up again using the same connection method, disconnect it first. Disable the connection between the device and printer in the Wi-Fi setting screen.

Connection Using a Wired Network

- You cannot establish a printer with wireless and wired connections at the same time.
- When using a router, connect the printer and a device to the LAN side (same network segment).

Print Professional Photos Using Print Studio Pro

Print Studio Pro is a plug-in that makes professional photo printing easier and more convenient. Applications such as Digital Photo Professional and Adobe Photoshop are supported.

In addition to printing bordered photos and borderless photos, you can perform various printing tasks such as index printing, grayscale printing and printing using ICC profiles.

You can also adjust the margins or add text.

Print Studio Pro has many other useful functions.

Refer to the following for details.

- What You Can Do with Print Studio Pro (Windows)
- What You Can Do with Print Studio Pro (Mac OS)



Browse/Print Photo Items Using Pro Gallery Print

Pro Gallery Print is a dedicated iPad app developed for the PRO series. This is an application that allows you to browse/print photo items from an iPad even from remote locations through integration with web services for professionals.

Pro Gallery Print is available for free from App Store.



►► Important

- Download requires registration for an App Store account.
- The application can be downloaded for free; however, transmission fees for connecting to App Store apply.
- Download is not possible if your operating system environment does not support the application. The application download page may not appear as well.

Managing Paper Information on Printer Using Media Configuration Tool

Media Configuration Tool is software for managing the paper information on the printer.

Use Media Configuration Tool to:

- Add new paper information to the printer by downloading the paper information file automatically from the Canon website when paper supported by the printer is newly added.
- Change the preferences such as display order and paper names for media types used on the printer's Operation Panel and in the printer driver's dialog boxes.
- Customize genuine Canon paper's paper information file to newly create a paper information file for your non-genuine paper.

Refer to the following for details.

- [Media Configuration Tool Guide \(Windows\)](#)

Managing Printer Status Using Device Management Console

Device Management Console is software for checking the printer status or color calibrating the printer.

Use Device Management Console to:

- Check the status of a printer connected via a network or USB.
- E-mail the administrator in case of a printer warning or error.
- Identify the color calibration status or perform color calibration.

Refer to the following for details.

■ [Device Management Console Guide \(Windows\)](#)

■ [Device Management Console Guide \(Mac OS\)](#)

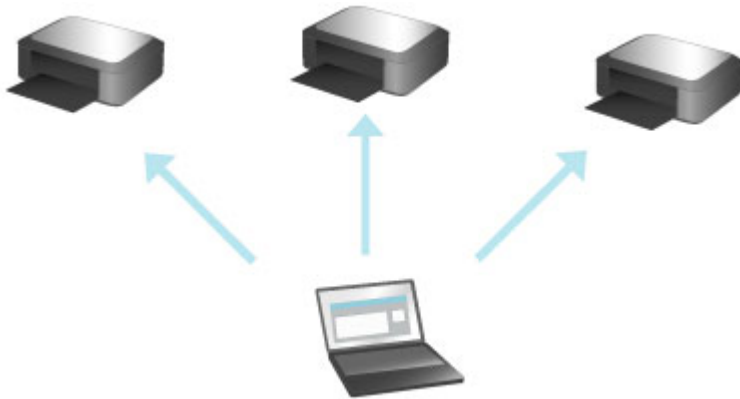

Using PIXMA/MAXIFY Cloud Link

By using PIXMA/MAXIFY Cloud Link, you can connect your printer to a cloud service, such as CANON iMAGE GATEWAY, Evernote, or Twitter, and use the following functions without using a computer:

- Print images from a photo-sharing service
- Print documents from a data management service
- Save scanned images to a data management service.
- Use Twitter to report the printer status, such as no paper or low ink levels.

In addition, you can use various functions by adding and registering apps that are linked with various cloud services.

■ Using PIXMA/MAXIFY Cloud Link from Your Printer

■ [Using PIXMA/MAXIFY Cloud Link from Your Smartphone, Tablet, or Computer](#)



▶▶▶ Important

- In certain countries, PIXMA/MAXIFY Cloud Link may not be available or the available apps may be different.
- Some apps require that you have an account before you use those apps. For such apps, please set up an account beforehand.
- To find out which models support PIXMA/MAXIFY Cloud Link check the Canon homepage.
- The screen display may change without prior notice.

Notice for Web Service Printing

When Using Web Service

- Canon does not guarantee the continuity and reliability of the web services provided, the availability of site access, or permission to download the materials.
- Canon may at any time update, change, or delete the information provided through the web service, or may suspend or discontinue the service without prior notice. Canon shall not be held responsible for any damages resulting from such actions.
- In no event shall Canon be liable for any damages whatsoever resulting from the use of the web services.
- User registration is necessary before you can use the external link site.
When you use the external link site, observe the conditions of use of the site and use the service within your own responsibility.
- All or part of the web service may not be available depending on the country or region you live in.
- Depending on your network environment, some functions on web service are not available. Even if they are available, it may take a while to print or display the contents, or communication may be interrupted while operation is in progress.
- When you use web service, your machine's name, information of your region or country, your selected language, and what kind of service you use (e.g. photo sharing site) are sent to and saved in our server. Canon is unable to identify specific customers using this information.
- Before you transfer ownership or dispose of a printer that supports a color LCD monitor, select **Device settings** -> **Reset setting** -> **Reset all** and delete your login name and password.
- For details, contact a Canon-authorized sales representative in the country or region you live in.

To Those Living in Mainland China

- PIXMA/MAXIFY Cloud Link, Easy-PhotoPrint+, and some functions of Canon PRINT Inkjet/SELPHY, which are included with this machine, are provided by Canon Inc.
However, as the server is installed outside of mainland China, some of these services may not be available yet.

Copyrights and Rights of Publicity

When printing using a service provided by Canon

1. The copyright of each material (photos, illustrations, logos, or documents: hereinafter referred to as "the materials") provided on the printing service belongs to their respective owners. Issues pertaining to Rights of Publicity may arise regarding the use of any of people or characters displayed on the printing service.

Except as otherwise permitted (please see "2" below), copying, modifying or distributing all or a portion of any of the materials contained on the web template printing service without prior consent of the respective rights (Rights of Publicity and Copyright) holder is strictly prohibited.

2. All of the materials provided on the web template printing service can be freely used for personal and non-commercial purposes.

Using PIXMA/MAXIFY Cloud Link from Your Smartphone, Tablet, or Computer

- ▶ **[Before Using Canon Inkjet Cloud Printing Center](#)**
- ▶ **[Registering User Information to Canon Inkjet Cloud Printing Center](#)**
- ▶ **[Using Canon Inkjet Cloud Printing Center](#)**
- ▶ **[Adding a Printer](#)**
- ▶ **[Adding a PIXMA/MAXIFY Cloud Link User](#)**
- ▶ **[Troubleshooting Canon Inkjet Cloud Printing Center](#)**

Before Using Canon Inkjet Cloud Printing Center

Canon Inkjet Cloud Printing Center is a service that links with the cloud function of the printer and allows you to perform operations such as registering and managing apps from your smartphone or tablet device, and checking the print status, print error, and ink status of the printer. You can also print app photos and documents from your smartphone or tablet.

First, check the following content:

- **Precautions**

If you plan to use the web service to print documents, be sure to check these [precautions](#) beforehand.

- **Printer specification**

Check that Canon Inkjet Cloud Printing Center supports the printer.

Some models do not support this function. To check whether your model supports this function, see "Models that Support Canon Inkjet Cloud Printing Center".

- **Network environment**

The printer must be connected to a LAN and to the Internet.

▶▶▶ Important

- The user will bear the cost of Internet access.

- **Operating requirements**

For computers, smartphones, and tablet devices, see "[Requirements for Canon Inkjet Cloud Printing Center operation](#)".

▶▶▶ Important

- This service may not be available in certain countries or regions. Also even if the service is available, there are apps that cannot be used in certain regions.

■ [Registering User Information to Canon Inkjet Cloud Printing Center](#)

Requirements for Canon Inkjet Cloud Printing Center operation

Computer

CPU	x86 or x64 1.6 GHz or higher
RAM	2 GB or higher
Monitor display	Resolution 1024 x 768 pixels or higher Number of display colors 24 bits (true-color) or higher

OS	Browser
Windows Vista SP1 or later	Internet Explorer 9 Mozilla Firefox Google Chrome
Windows 7	Internet Explorer 9, 10, 11 Mozilla Firefox Google Chrome
Windows 8	Internet Explorer 10, 11 Mozilla Firefox Google Chrome
Windows 8.1	Internet Explorer 11 Mozilla Firefox Google Chrome
Mac OS X v10.6-OS X Mavericks v10.10	Safari 5.1, 6, 7, 8

Smartphone or tablet

OS	Browser	Resolution
iOS 6.1 or later	OS standard browser	320 x 480 or higher
Android 2.3.3 or later		480 x 800 or higher

*Android3.x is not supported.

The operation requirements may change without prior notice. If this happens, you may no longer be able to use this service from your computer, smartphone, or tablet.

»»» Important

- On the browser you are using, enable JavaScript and cookies.
- If you use the zoom function or change the font size on your browser, the web pages may not display correctly.
- If you use the translation function of Google Chrome, the web pages may not display correctly.
- The service does not support the use of its provided services through a proxy server outside of your country.
- In an in-house network environment, the 5222 port must be released. For confirmation instructions, contact the network administrator.

Registering User Information to Canon Inkjet Cloud Printing Center

To use the Canon Inkjet Cloud Printing Center, you need to follow the steps described below and register **My account** information.

- If your model has color LCD monitor
- If your model has monochrome LCD monitor
- [If your model has no LCD monitor/If you are using PRO-1000 series or PRO-500 series](#)

Registering User Information to Canon Inkjet Cloud Printing Center (No LCD Monitor/Using PRO-1000 series or PRO-500 series)

To use the Canon Inkjet Cloud Printing Center, you need to follow the steps described below and register **My account** information.

Registering from Your Smartphone, Tablet, or Computer

1. Check that the printer is connected to the Internet

▶▶▶ Important

- To use this function, you must connect this printer to the Internet.

2. Displaying Printer Information

For details, go to the *Online Manual* home page, and see "Checking Printer Information" for your model.

3. Select **IJ Cloud Printing Center setup -> Register with this service**

4. Follow the instructions displayed in the window, and run the authentication

5. When the **Preparation for registration** screen appears, select **Send blank e-mail**

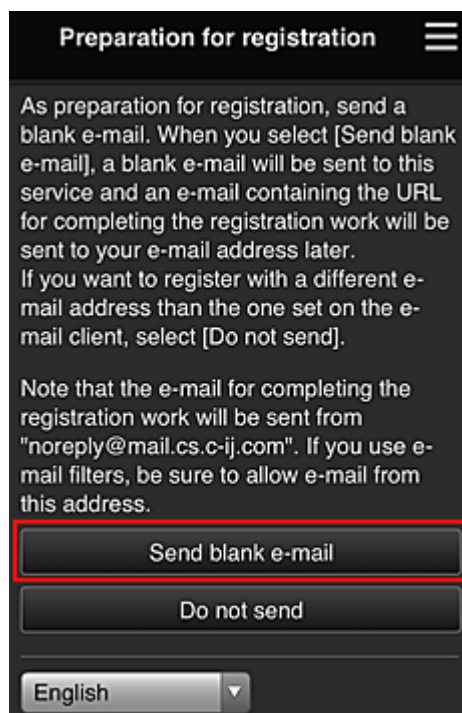

▶▶▶ Note

- When you select **Send blank e-mail**, the "destination entry completed" mailer starts up automatically.
After the blank e-mail is created, send that e-mail without making any changes.

If you want to register a different e-mail address, select **Do not send** to display the **E-mail address** entry screen.

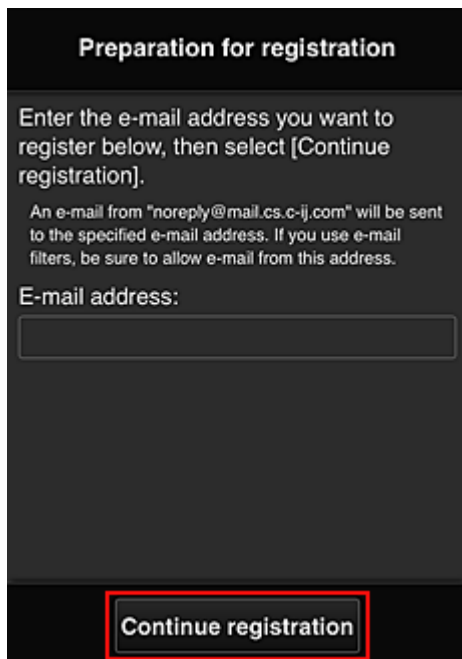

In the displayed screen, enter the **E-mail address** that you want to register, and then select **Continue registration**.

▶▶▶ Note

- If you enter an e-mail address that has already been registered, you will receive an "already registered" e-mail. Follow the instructions in the e-mail, and register a different e-mail address.

▶▶▶ Important

- There are character restrictions for the e-mail address, as shown below.
 - Up to 255 characters consisting of single-byte alphanumeric characters and symbols (!\$*/^_{}|~.-@). (Uppercase and lowercase letters are differentiated.)
 - Multibyte characters cannot be used.
You will get an error if the e-mail address you enter contains a character that cannot be used.
- If you registered a different e-mail address by mistake, you can cancel the registration by Displaying Printer Information and selecting **IJ Cloud Printing Center setup -> Delete from this service**.
To display printer information, go to the *Online Manual* home page, and see "Checking Printer Information" for your model.
- You may not be able to receive the notification if you are using a spam filter. If you have a setting to receive only the e-mails from certain domains, be sure to change the setting to allow receiving e-mails from "noreply@mail.cs.c-ij.com".
There will be no error display even if you could not receive the e-mail because of the spam filter setting or if you entered an incorrect e-mail address.

6. Check that you received blank e-mail, and then select **Yes**

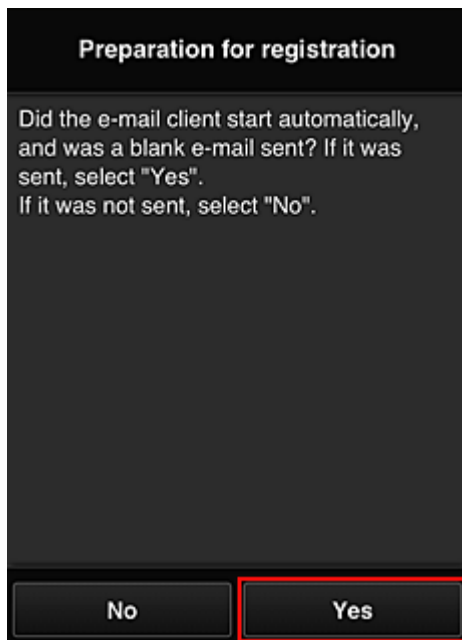

7. Follow instructions in screen display, and select **OK**

The registration page URL will be sent to the registered e-mail address.

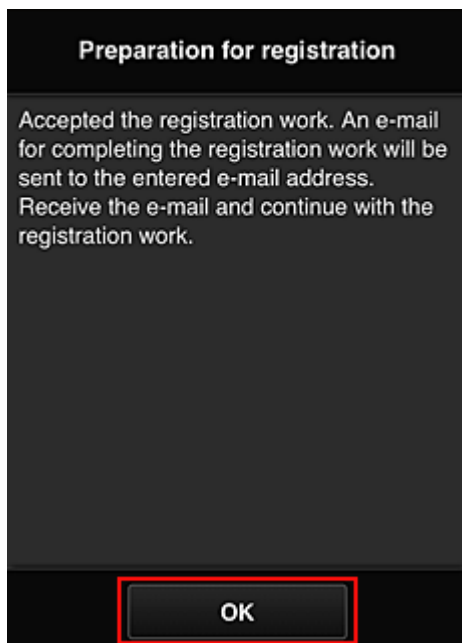

Access the URL in the e-mail, Register the Information, and Complete the User Registration

1. Check that e-mail containing URL has been sent to registered e-mail address, and access URL
2. In the **License agreement** and **Privacy statement** windows of Canon Inkjet Cloud Printing Center, read the statements, and select **Agree** if you agree

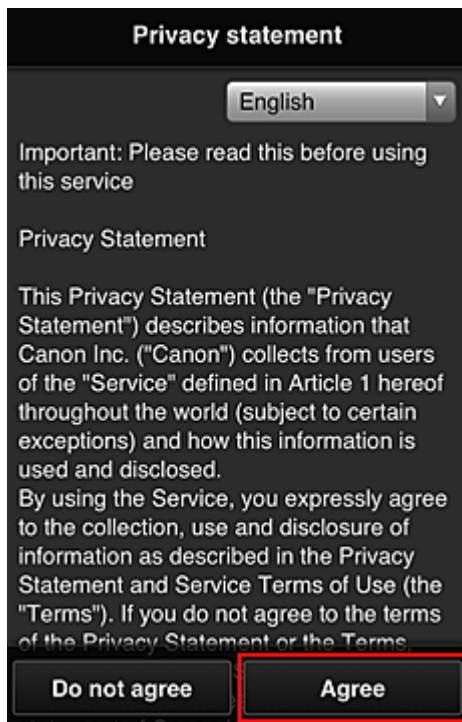
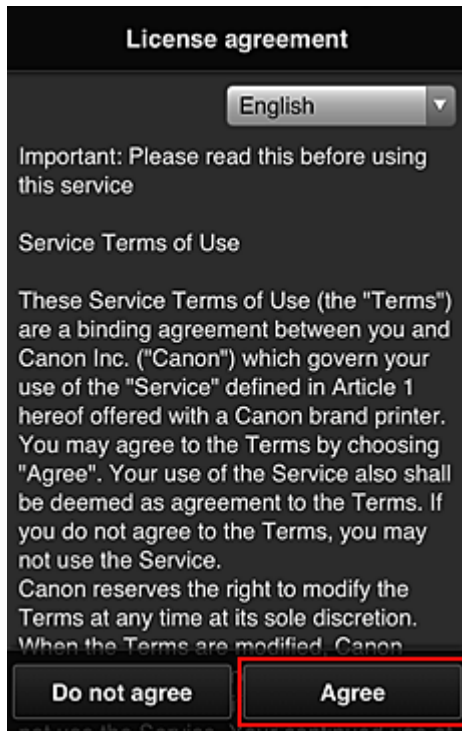

3. Register password for logging in to Canon Inkjet Cloud Printing Center

In the My account registration screen, enter the password you want to register into **Password** and **Password (Confirmation)**, and then select **Next**.

Register My account

Set a password for logging into this service.

Password:

Password (Confirmation):

8 to 32 characters

Cancel Next

»» Important

- There are character restrictions for the **Password**, as shown below.
- The password must be between 8 and 32 characters long, using single-byte alphanumeric characters and symbols (!"#\$\$%&'()*+,-./:;<=>@[¥]^_`{|}~). (Alphabets are case-sensitive)

4. Enter **Nickname**

Enter any user name you want to use.

Register My account

Nickname:

1 to 20 characters

Time zone:

(UTC) Coordinated Universal Time ▼

Back Done

»» Important

- The user name entry field has the following character restrictions:
 - The user name must be between 1 and 20 characters long, using single-byte alphanumeric characters and symbols (!"#\$\$%&'()*+,-./:;<=>@[¥]^_`{|}~). (Alphabets are case-sensitive)

5. Specify the **Time zone** setting, and select **Done**

Select your region on the list. If you cannot find your region on the list, select the one closest to your region.

Apply daylight saving time

This appears only when there is a daylight saving time in the **Time zone** that you selected. Select whether or not to apply the daylight saving time.

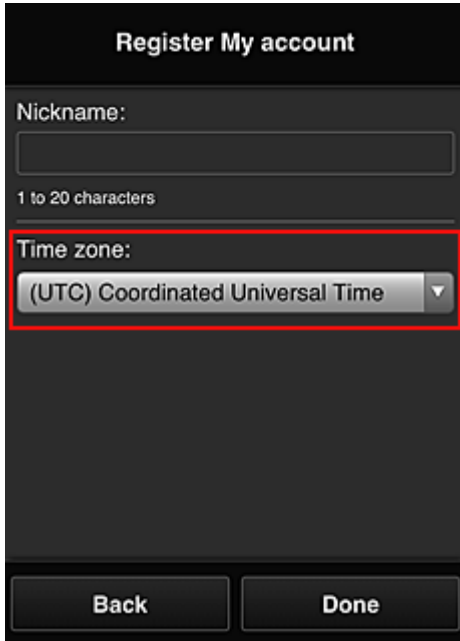

The registration is complete. A registration completion message is displayed. When you select the **OK** button in the message, the login screen is displayed.

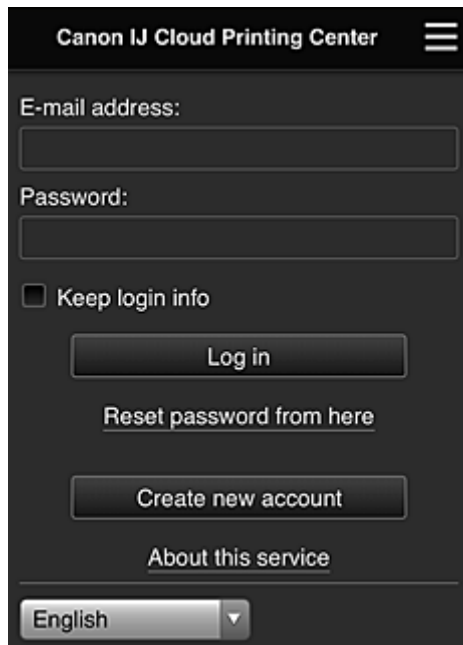

Enter the registered **E-mail address** and **Password**, and [Log in](#) to the Canon Inkjet Cloud Printing Center.

■ [Using Canon Inkjet Cloud Printing Center](#)

Using Canon Inkjet Cloud Printing Center

When the user registration is completed, you can log in to the Canon Inkjet Cloud Printing Center and use the service.

1. From your PC, smartphone, or tablet, access the service login URL (<http://cs.c-ij.com/>)
2. On the Login screen, enter the **E-mail address** and **Password**, and then select **Log in**

▶▶▶ Important

- The e-mail address and password are case-sensitive. Make sure the case is correct.

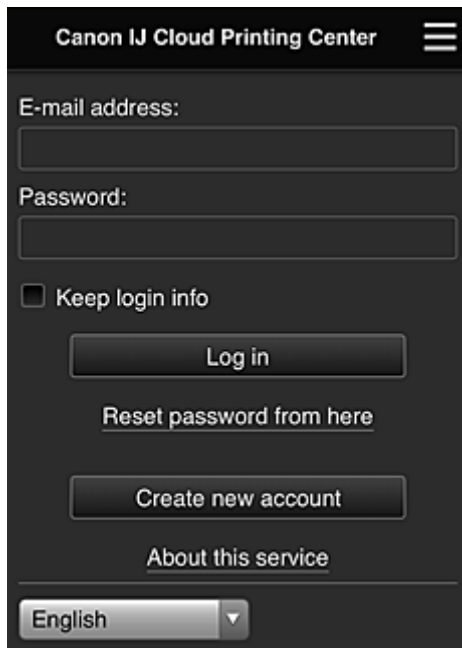

E-mail address

Enter the e-mail address that you entered in the user registration.

Password

Enter the password that you entered in the user registration.

Keep login info

When you select the check box, the login screen is skipped for 14 days since the last day that the service screen was accessed.

▶▶▶ Important

- If you fail to log in five straight times, you will not be able to login again for about the next 60 minutes.
- You remain logged in for 60 minutes after the last access.
- The service may not function properly if you log in by using the same e-mail address from multiple devices at the same time.

After logging in, you can use useful services such as adding/managing apps that work in conjunction with this product's cloud functionality and checking the ink status.

For screen descriptions and operation instructions, see "[Canon Inkjet Cloud Printing Center window](#)".

Printing procedure

This section introduces the photo printing procedure by using CANON iIMAGE GATEWAY as an example.

▶▶▶ Important

- The available functions differ depending on the app.
- The printing procedure differs depending on the app.
- You need to get the account and register photo and other data beforehand.
- The following file formats can be printed: jpg, jpeg, pdf, docx, doc, xlsx, xls, pptx, ppt, and rtf.
The file formats that can be printed differ depending on the app.
- Before you print, check that printer is on and is connected to the network. Then start.
- This is available if you are using a smartphone or tablet.

▶▶▶ Note

- You can use CANON IMAGE GATEWAY to print jpg and jpeg file formats.

1. On the Main screen, select the app to be used
2. Enter the information according to the instructions on the authentication screen, and then select **Log in**

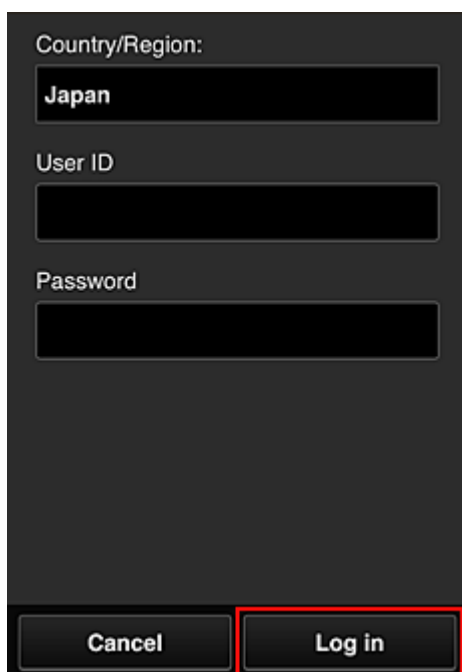

The image shows a dark-themed authentication screen. At the top, it says "Country/Region:" followed by a dropdown menu showing "Japan". Below that is a "User ID" field, which is currently empty. Underneath is a "Password" field, also empty. At the bottom of the screen, there are two buttons: "Cancel" on the left and "Log in" on the right. The "Log in" button is highlighted with a red rectangular border.

3. In the displayed album list, select the album of your choice

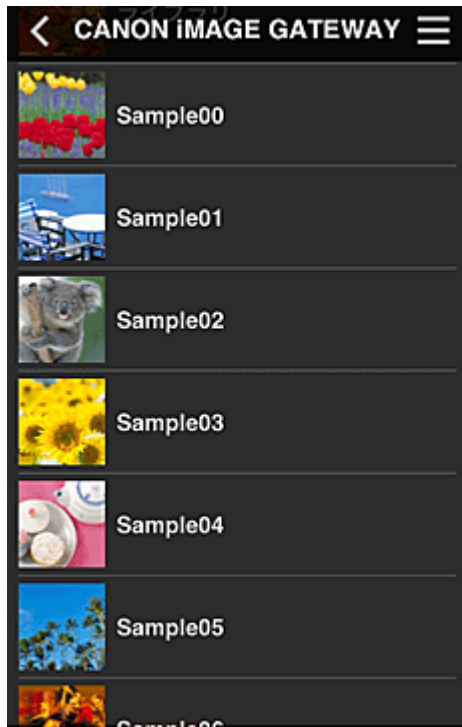

4. In the displayed image list, select the image that you want to print, and then select **Next**



5. Make the necessary print settings, and then select **Print**

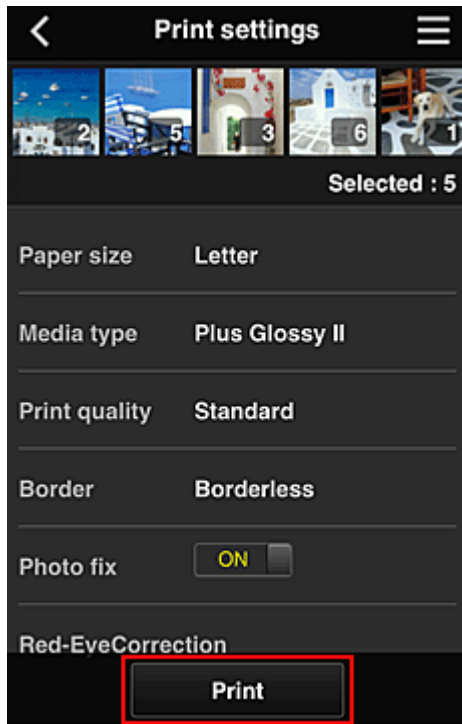

6. A print job completion message appears, and printing starts

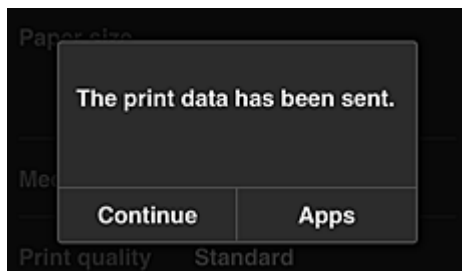

To continue printing, select **Continue**, and perform the operation from Step 3.

To end the printing, select **Apps**. The screen returns to the apps list screen.

»» Important

- If a print job is not printed within 24 hours after the print job is issued, the print job will expire and cannot be printed.
- With premium apps that limit the number of print jobs, print jobs that expire and cannot be printed are also included in the print count.

■ [Adding a Printer](#)

Canon Inkjet Cloud Printing Center window

This section describes the Canon Inkjet Cloud Printing Center screens that are displayed on your smartphone, tablet device, or computer.

- [Description of the Login screen](#)
- [Description of the Main screen](#)

Description of the Login screen

This section provides the description of the Login screen of Canon Inkjet Cloud Printing Center.

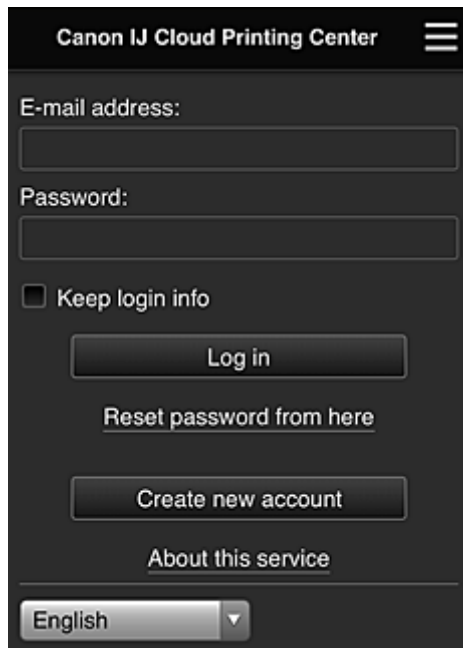

►►► Important

- You have 5 tries to enter your password. If you fail, you will not be able to log in for about the next 60 minutes.
- You remain logged in for 60 minutes after the last access.

Language

Select the language you will be using.

E-mail address

Enter the e-mail address that you entered in the user registration.

►►► Important

- The e-mail address is case-sensitive. Make sure the case is correct.

Password

Enter the password that you entered in the user registration.

Keep login info

When you select the check box, the login screen is skipped for 14 days since the last day that the service screen was accessed.

Reset password from here

Select this if you forgot the password.

Reset your password by following the instructions on the screen.

Create new account

A new registration will be added to the Canon Inkjet Cloud Printing Center.
For a new registration, you need the Printer registration ID.

About this service

This displays the descriptions of this service.

System requirements

This displays the system requirements for the Canon Inkjet Cloud Printing Center.

Software license info

The licensing information of Canon Inkjet Cloud Printing Center is displayed.

Description of the Main screen

When you log in to the Canon Inkjet Cloud Printing Center, the Main screen appears.
If you are using a smartphone or a tablet, you can also print photos and documents.

▶▶▶ Important

- With this service, the available functions differ depending on whether the user is the [Administrator](#) or [Standard user](#) of the printer, and also on the management method that was set.

You can use areas shown below to start, add, and manage apps.

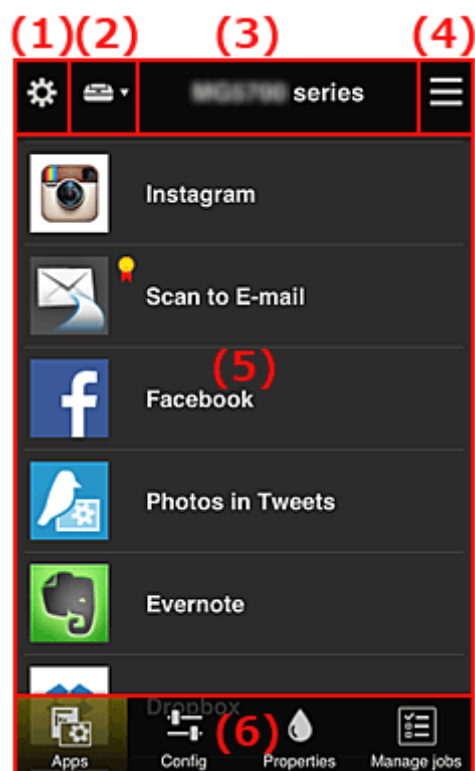

- (1) [Left context menu \(Administrator only\)](#)
- (2) [Select printer](#)
- (3) [Printer name area](#)
- (4) [Right context menu](#)
- (5) [Display area](#)
- (6) [Menu area](#)

(1) Left context menu (Administrator only)

When you select , the left context menu appears.

When you select **Mng. printer**, **Manage users**, **Group management**, or **Advanced management**, the corresponding screen appears.

▶▶▶ Note

- **Group management** appears only when you use [Select how to manage](#) and set **Manage by group (for office users)**.

Mng. printer screen

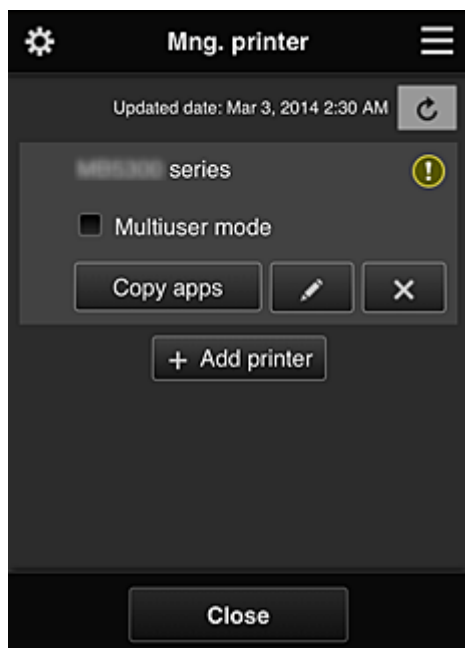

From the **Mng. printer** screen, you can [check](#) or [update](#) printer information registered to the Canon Inkjet Cloud Printing Center, [copy apps](#), [change printer names](#), [delete printers](#), and [add printers](#).

• Check the printer information

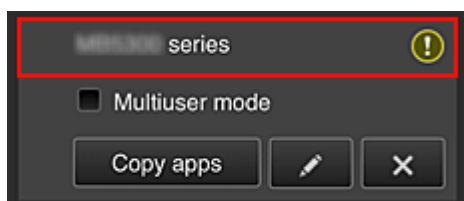

The registered printer name is displayed.

 indicates that an error occurred on the printer.

• Display update date/time of the printer information

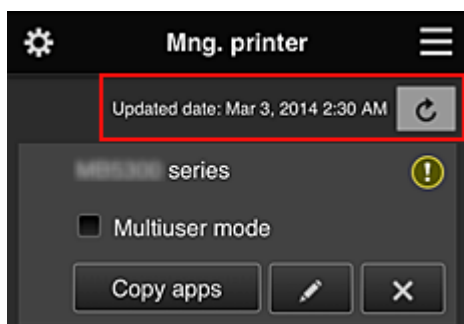

This displays the date and time the printer information was last updated.

 refreshes the information.

- **Multuser mode (MAXIFY series only)**

If multiple users will be using the printer, add a check mark to [Multuser mode](#).

The check mark is linked to the **Require security code** screen.

- **Copy apps**

Select this to copy apps added in the selected printer to another printer.

When you select , the screen shown below appears.



Set the **Destination printer** and the **Source printer**. Then select **OK**.

▶▶▶ Note

- If **Select how to manage** has been set, you can use this function only when you select **Manage app availability by printer**.

For details, see "[Tips on Using Canon Inkjet Cloud Printing Center \(at Work\)](#)".

- **Change the printer name**

When you select , a screen to change the printer name appears.

Follow the instructions on the screen to change the name.

▶▶▶ Important

- The printer name entry has the following character limitation:
 - Up to 128 characters (Uppercase and lowercase letters are differentiated.)

- **Delete printers**

When you select , the printer is deleted from the Canon Inkjet Cloud Printing Center.

When transferring the ownership of the printer, select **Clear the information saved on the printer**.

- **Add printers**

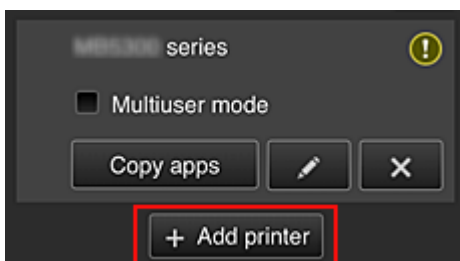

Select this to add printers to be used in the Canon Inkjet Cloud Printing Center.
You need a Printer registration ID to add a printer.

▶▶▶ Note

- Although the number of printers that can be registered for one domain is not limited, only up to 16 printers are guaranteed to operate.

Manage users screen

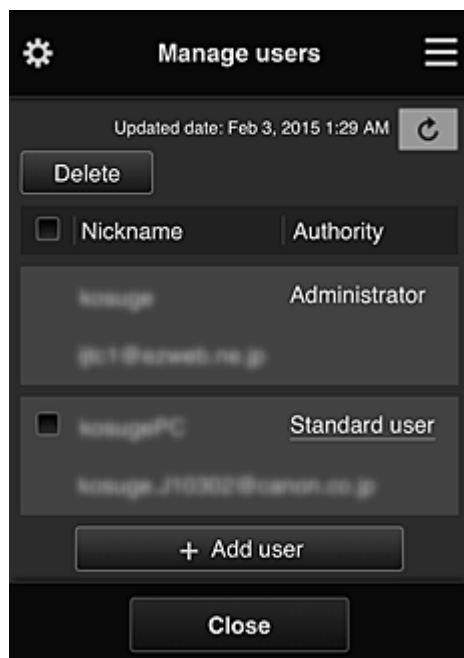

From the **Manage users** screen, you can check user information registered to the Canon Inkjet Cloud Printing Center, [delete users](#), [add users](#), and [change the Administrator and Standard user settings](#).

• User deletion

Select the check box of the user to be deleted, and select **Delete**.

However, you cannot delete yourself. To delete yourself, cancel your membership from the [My account](#) screen.

• Adding a user

Select **Add user**. The user registration screen appears.

• Changing Administrator and Standard user settings

To change the privileges of the **Administrator** or a **Standard user**, select **Authority** for the user whom you want to change the settings for.

Group management screen

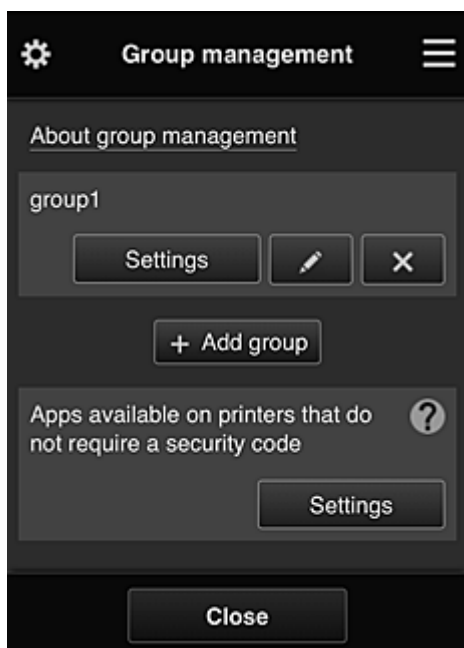

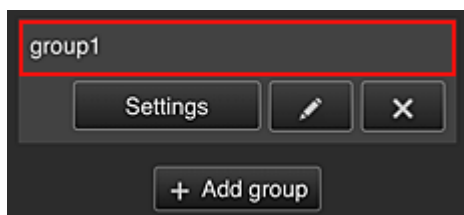

From the **Group management** screen, you can use functions for [checking group information](#) registered to Canon Inkjet Cloud Printing Center, [changing groups](#), [deleting groups](#), [adding groups](#), and setting up users, printers, and apps belonging to each group.

- **Checking group information**



The registered group names appear.

If there are items that have not been set,  appears.

Select  to display the following screen, which allows you to set up information for each group.

The displayed information changes depending on the selected tab.

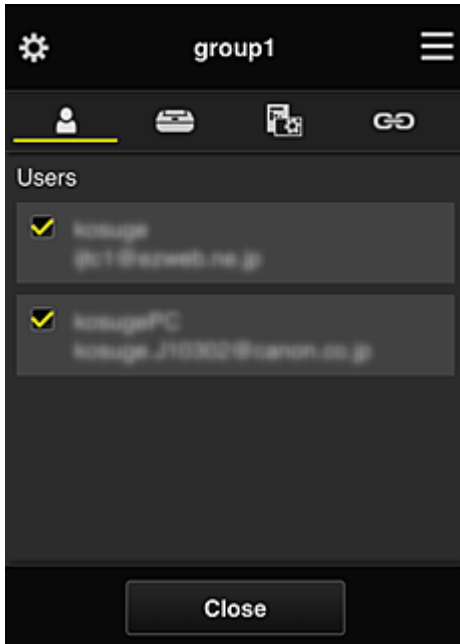

 **Users**

Displays all users and mail addresses registered in the domain.

 **Printers**

Displays all printers registered in the domain.

 **Apps**

With the default settings, the screen displays all apps. To display only registered apps, select the **Registered** category.

To switch between app registration/deletion, select ON / OFF.

 **Web services**

Displays the external link service.

You can restrict the use of other web services that use Canon Inkjet Cloud Printing Center accounts such as Easy-PhotoPrint+.

To switch between service linking/release, select ON / OFF.

 appears for items that do not have anything selected.

In the default settings, all check marks are cleared for **Printers** and **Users**. Only the system apps under **Apps** are set to **ON**.

• **Changing a Group name**

To display the **Group name** change screen, select .

You can change the name to one of your liking by following the instructions in the displayed screen.

Important

- When you enter a **Group name**, the following restrictions apply:
 - When using single-byte alphanumeric characters, enter at least 1 but not more than 20 characters. When using double-byte characters, enter at least 1 but not more than 10 characters.
 - Duplicate group names cannot be registered in the same domain.

- **Deleting a Group**

To delete a group from Canon Inkjet Cloud Printing Center, select .

If you delete all groups, you must create a new one. To set a different management method, set the target method from the **Select how to manage** screen.

- **Add group**

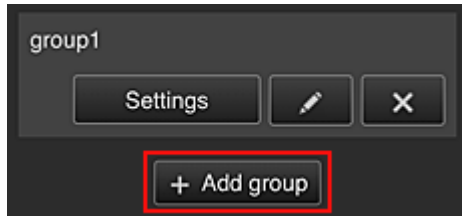

Add a group to be used in Canon Inkjet Cloud Printing Center.

▶▶▶ Note

- You can register up to 20 groups.

- **Apps available on printers that do not require a security code**

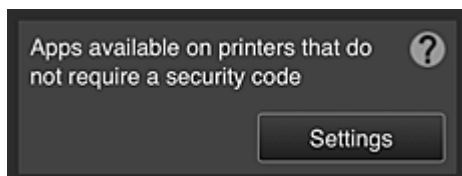

For printers without the **Multuser mode** setting or **Security code** settings, set the apps to be

displayed when a user selects  **Cloud** from the printer's home screen.

If the domain does not have a printer that meets this condition, this setup screen does not appear.

To go to the setup screen, select .

▶▶▶ Note

- If only the following printer is registered in the domain, it is not displayed.
 - Printer without LCD monitor
 - Printer with monochrome LCD monitor
 - Multuser mode printer

Advanced management screen

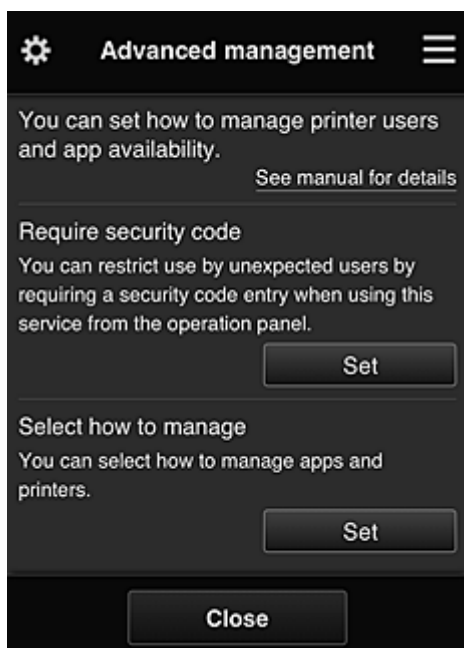

The **Advanced management** screen allows you to set the management method for printer users and apps that can be used.

To go to the setup screen, select .

- **Require security code**

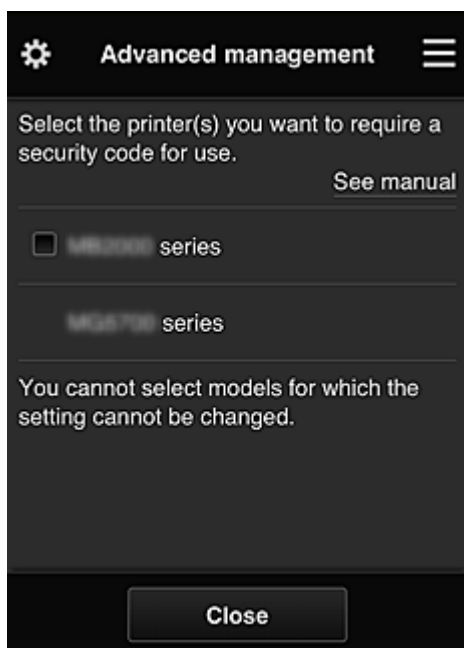

Each user can set a [Security code](#), start the app, and perform printing and other operations. This setting is linked with **Multiuser mode** on the **Mng. printer** screen.

▶▶▶ Note

- The list does not display models without an LCD or models with a monochrome LCD.
- The check box does not appear for models that do not support **Multiuser mode**.

- **Select how to manage**

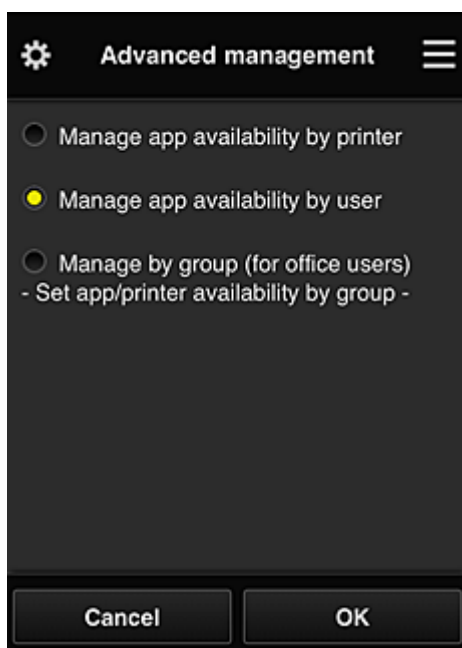

You can change the management method for usable apps and printers.

Manage app availability by printer

If you are using multiple printers, you can manage the useable apps for each printer.

Manage app availability by user

When one printer is used, you can manage the usable apps by user.

For usage examples, see "[Tips on Using Canon Inkjet Cloud Printing Center \(at Home/If you are using PRO-1000 series or PRO-500 series\)](#)".

Manage by group (for office users)

You can manage the usable apps and printers by group.

For usage examples, see "[Tips on Using Canon Inkjet Cloud Printing Center \(at Work\)](#)".

▶▶▶ Note

- If you manage the usable apps by printer, the default settings will allow all users to add, delete, and rearrange apps.
Also, if you are using a MAXIFY series printer and you select **Multuser mode** in the [Mng. printer screen](#), only the administrator will be able to add, delete, and rearrange apps.
- If you manage the usable apps by user, all users will be able to add, delete, and rearrange apps, regardless of the **Multuser mode** setting.
- If you manage the usable apps and printers by group, all users will only be able to rearrange apps.

(2) Select printer

Select , and then from the **Select printer** screen, select a printer.

If you are using a computer, you can select a printer directly from the pull-down menu.

▶▶▶ Note

- Printers with settings that restrict their use do not appear.

(3) Printer name area

The registered name of the printer selected is displayed.

The **Administrator** can [change the printer name](#) from the **Mng. printer** screen of the left context menu.

(4) Right context menu

When you select , the context menu appears.

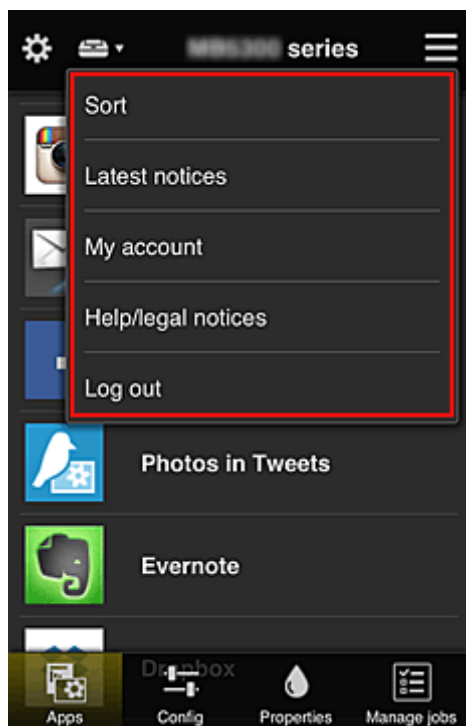

The information displayed depends on the menu currently selected in the menu area.

The  symbol indicates that there is a new unread notice.





• Sort

This displays the screen to sort registered apps.

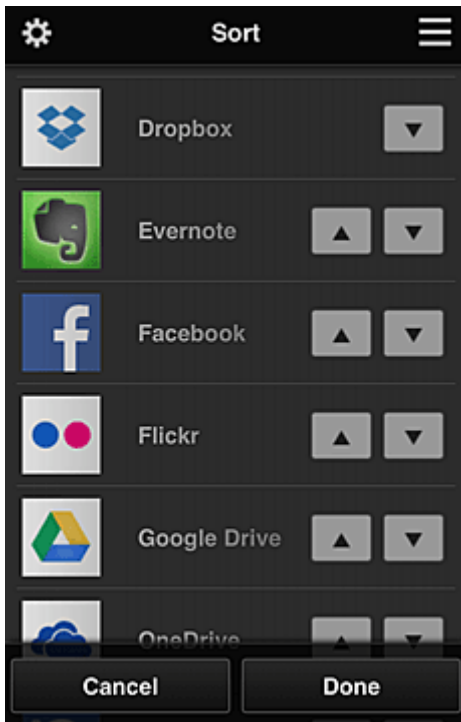
You can use the   buttons to change the display order of apps. When you finish sorting, select **Done**.



»» Note

- Description of displayed icons
 -  : Cannot be used because it is not yet released or does not support your region, model, or language.
 -  : Can be used with genuine Canon ink.

• Latest notices **Latest notices**

This displays the latest notices. The  symbol indicates that there is a new unread notice.

• My account **My account**

Displays user information.

From the **My account** screen, you can change your account settings.

From the **My account** screen, you can display the **Permitted services** screen and clear any linked service setting.

• Help/legal notices **Help/legal notices**

The description of the Canon Inkjet Cloud Printing Center screen and various reminders are displayed.

• Log out **Log out**

This opens the Log out screen of the Canon Inkjet Cloud Printing Center.

(5) Display area

The display changes based on the menu you select.

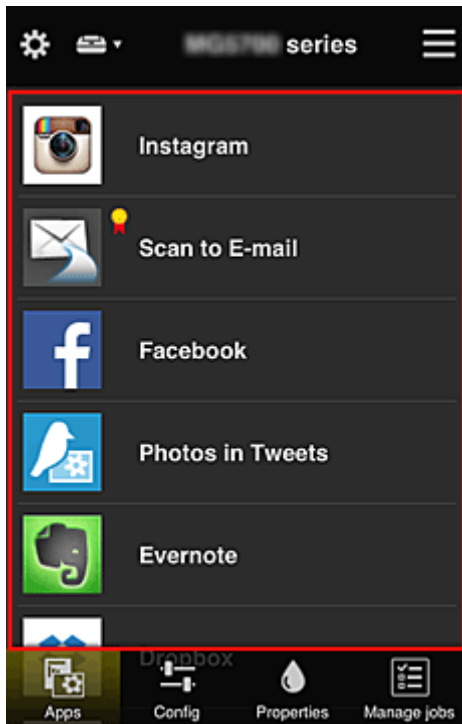

(6) Menu area

The following 4 menu buttons are displayed:

-  **Apps**

This displays the list of registered apps in the [Display area](#).

-  **Config**

This displays the Register apps screen in the [Display area](#).

The display can be toggled between **Registered** and **Search apps**.

The **Registered** screen lists registered apps.

You can check the information of these apps or deregister them.

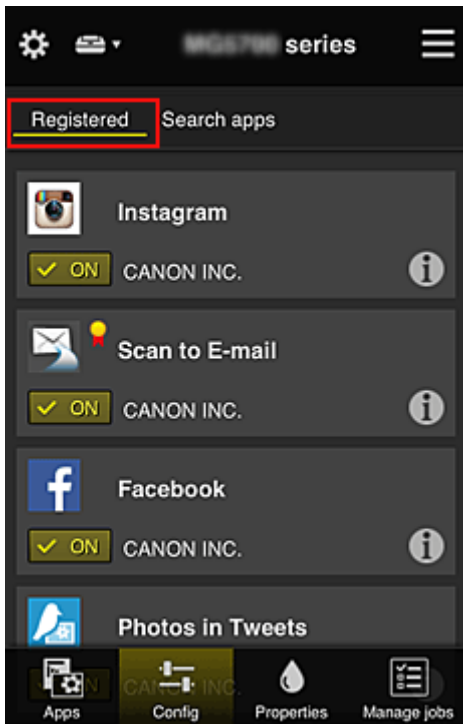

➤➤➤ Note

- If **Group management** has been set, **Config** is not displayed.
- If **Manage app availability by user** has been set, even **Standard user** can register and delete apps.



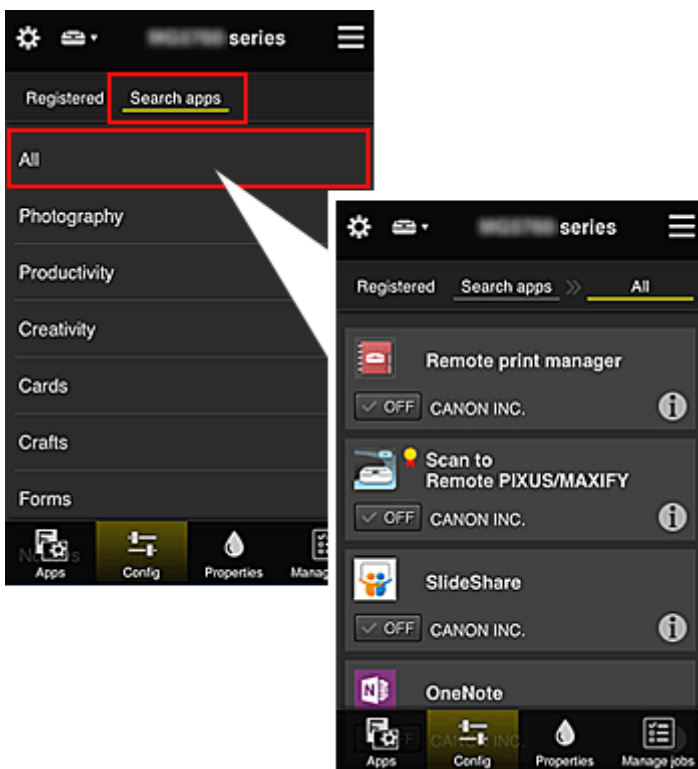

On the **Search apps** screen, the apps that you can register by using the Canon Inkjet Cloud Printing Center are displayed by category.



- When you select , the details of the app are displayed.
- When you select  / , you can choose to register or unregister the app.

➤➤➤ Note

- Description of displayed icons
 -  : Cannot be used because it is not yet released or does not support your region, model, or language.
 -  : Can be used with genuine Canon ink.



- **Properties**

This screen displays the status of the printer that is currently selected.

You can check how much ink is remaining or details about an error that occurred. You can also access the ink purchasing site and the *Online Manual*.

»» Important

- The Properties displayed may differ from the actual status at the display time, depending on the printer status.



- **Manage jobs**

This screen displays the print or scan status and history.

You can check the print or scan status by looking at **Status list**, and the print or scan history by looking at **History**.

You can also cancel print or scan jobs and delete history information.

To cancel or delete a job, select that job and then select **Cancel** or **Delete**.

Tips on Using Canon Inkjet Cloud Printing Center (at Home/If you are using PRO-1000 series or PRO-500 series)

The **Advanced management** function allows you to take advantage of the many useful functions that the service offers for home use.

This section introduces those functions by using a family of 3 (father, mother, and child) as an example.



If the father registers the printer to Canon Inkjet Cloud Printing Center, only the father is managed by the service, and the mother and the child cannot use the service unless the father tells them the login **E-mail address** and **Password**.

If Mother and Child Want to Use the Service from Their Smartphones

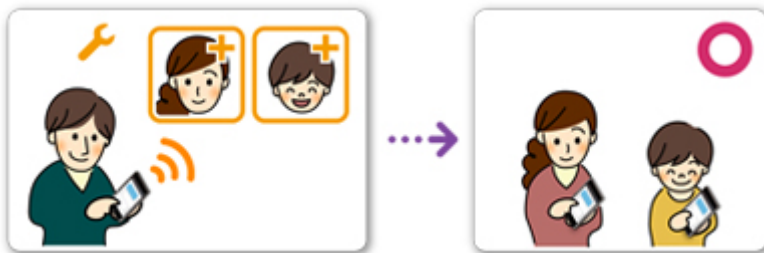

1. The father [registers to Canon Inkjet Cloud Printing Center](#) and becomes the **Administrator**
2. After logging in, the father selects [Manage users](#) from 

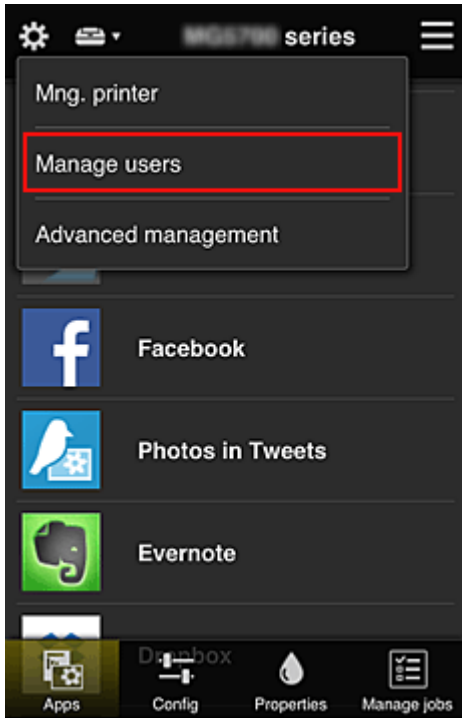

3. The father selects **Add user**, and by following the screen instructions, registers the mother and child as users.

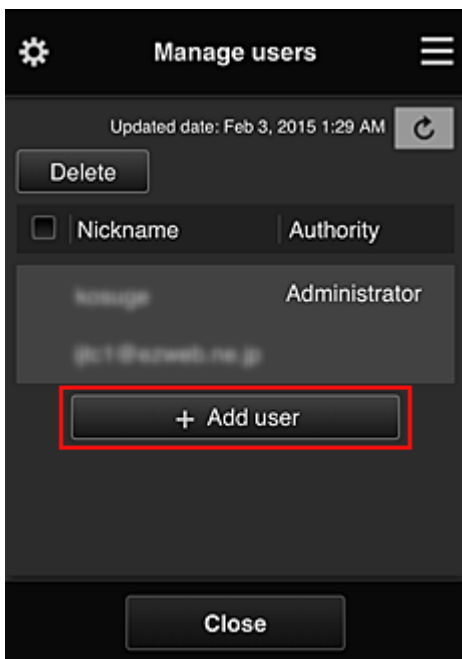

After this registration is complete, the mother and child can individually use the service.

If Father, Mother, and Child Want to Manage Apps Individually

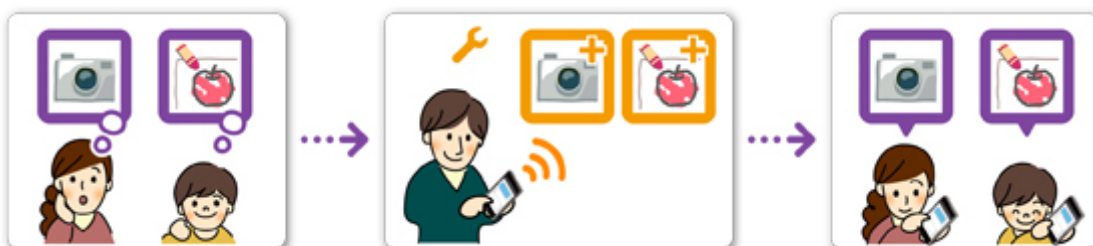

With the default settings, only the **Administrator** (father) can register apps to be used or delete apps. After the **Administrator** (father) specifies settings according to the procedure below, the father, the mother, and the child will be able to manage apps individually.

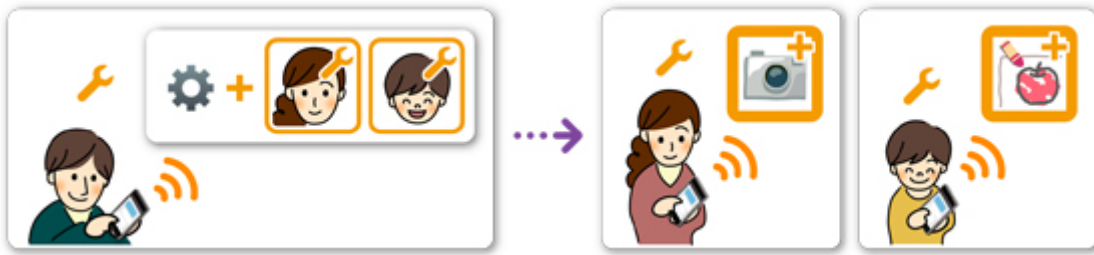

1. As the **Administrator**, the father [logs in to Canon Inkjet Cloud Printing Center](#) and selects **Advanced management** from 

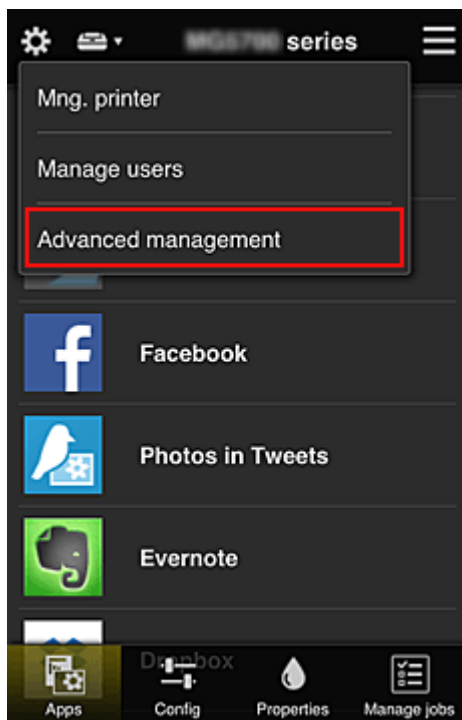

2. For **Select how to manage**, the father selects **Set**



3. The father sets **Manage app availability by user** and selects **OK**

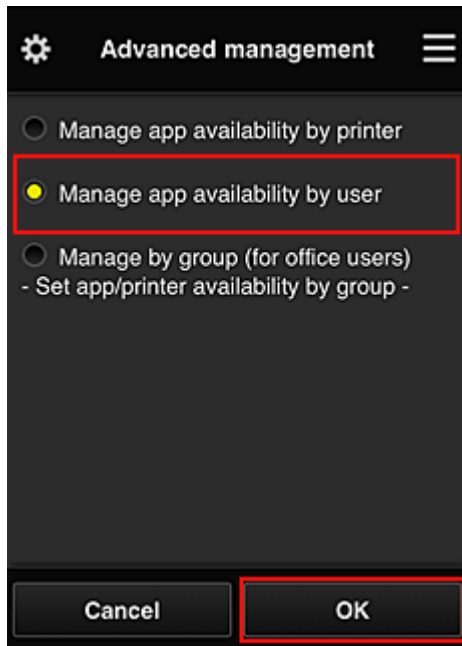

4. The screen for checking the management method change appears

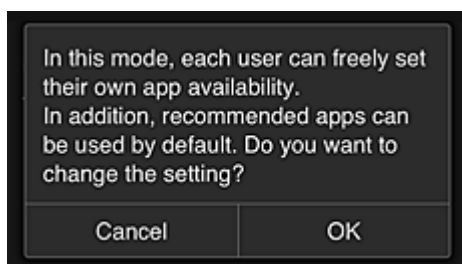

To complete the setup and return to the **Advanced management** window, select **OK**.
All registered users can register and delete apps freely.

Tips on Using Canon Inkjet Cloud Printing Center (at Work)

The **Group management** function allows you take advantage of the many useful functions that the service offers for office use.

This section introduces an example in which two printers are used, the **Administrator** is the senior clerk, and the other members are the company president, the section manager, and the new hire.

»»» Note

- If the second printer has not been registered, select "[Adding a Printer](#)" and register the printer by following the procedure.

Creating a Group for All Office Members to Use

Set the basic group.

In this example, only the Evernote app will be used on 2 printers.

1. The senior clerk [registers to Canon Inkjet Cloud Printing Center](#) and becomes the **Administrator**
2. The senior clerk selects [Manage users](#) from 

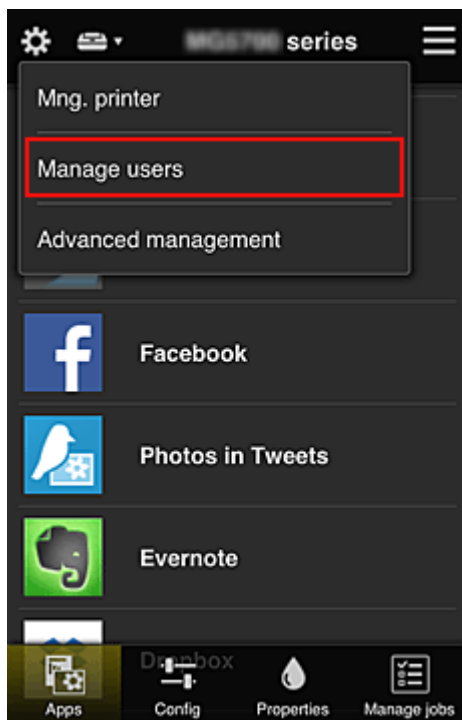

3. On the displayed screen, the senior clerk selects **Add user** and registers the company president, the section manager, and the new hire as users

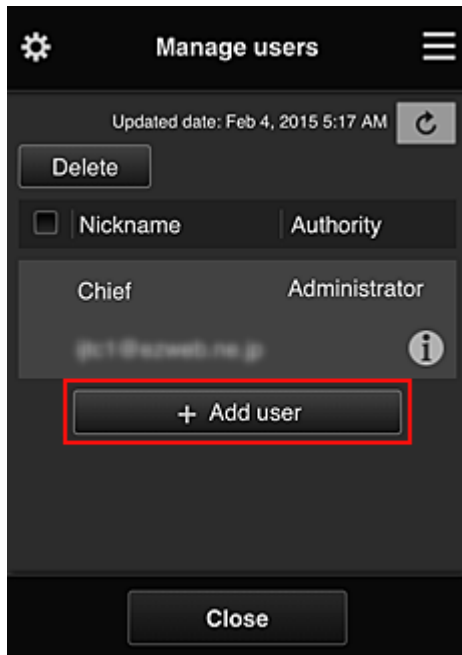

4. The senior clerk selects **Advanced management** from 

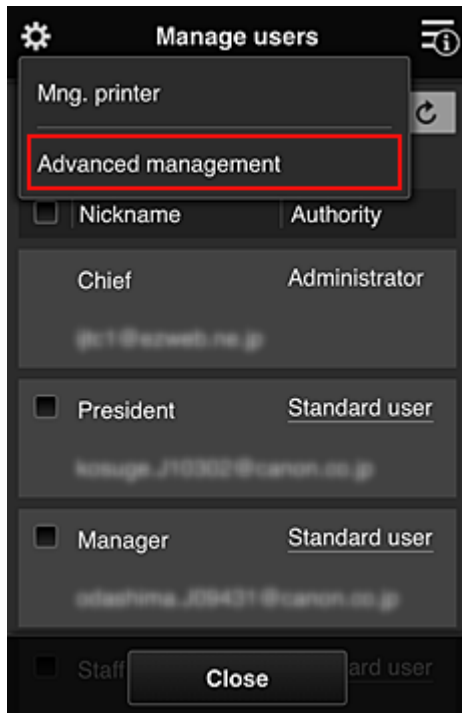

5. For **Select how to manage**, the senior clerk selects **Set**

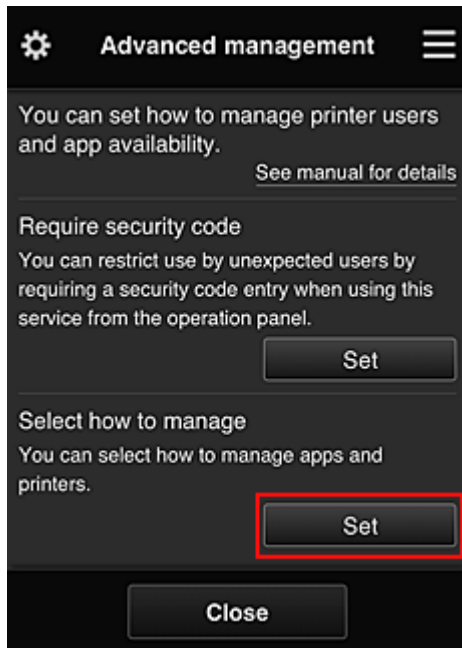

6. The senior clerk sets **Manage by group (for office users)** and selects **OK**

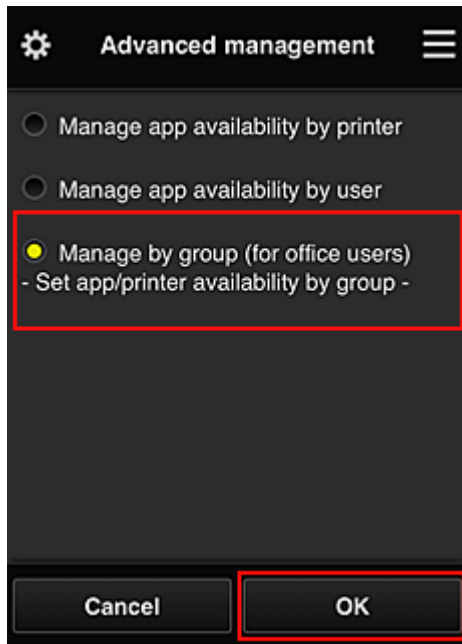

➤➤➤ **Note**

- If **Group management** has already been set up, refer to step 10 and the subsequent steps.

7. On the screen for checking management method changes, the senior clerk checks the displayed information and selects **OK**.

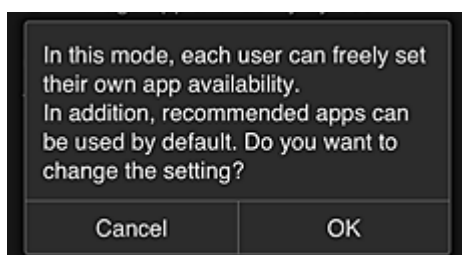

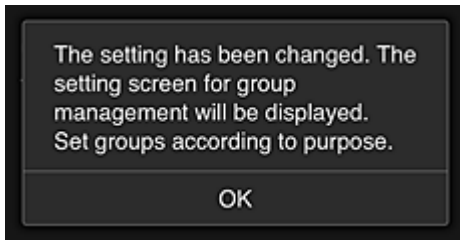

This appears only if the selected mode is **Group management**.

To complete the setup and display the **Group management** screen, select **OK**.

»» Note

- With the default settings, the group is named "group1".
- With the default settings, all registered users belong to the same group.

8. In the **Group management** screen, the senior clerk selects the  of the group to be renamed

9. The senior clerk enters the **Group name** and selects **OK**

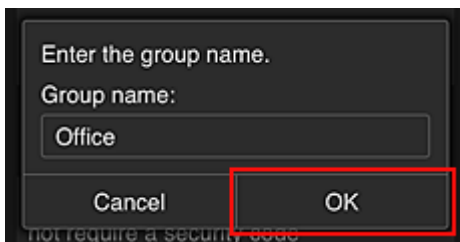

The chief clerk enters "Office" here because the clerk is setting up a group that everyone in the office will use.

»» Important

- The following restrictions apply to entering the **Group name**.
 - The group name can have up to 20 single-byte alphanumeric characters or up to 10 double-byte characters.
 - The same group name cannot be registered more than once in the same domain.
 - Up to 20 groups can be registered.
- The person who created the group becomes the **Administrator**.

10. Select **Settings**, and in group setup screen, check that all users on the **Users** tab are selected

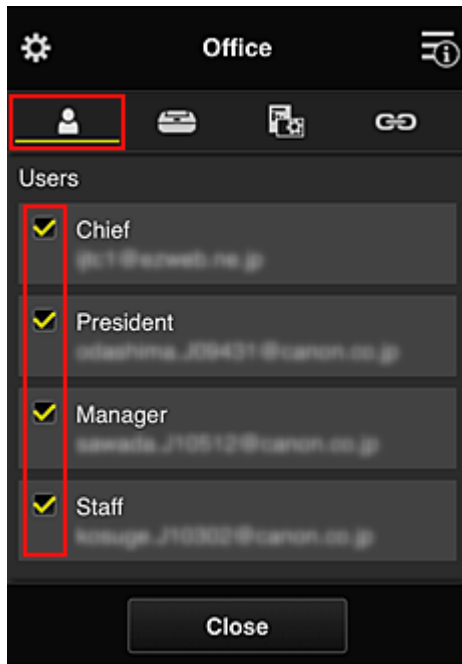

11. On **Printers** tab, check that all printers are selected

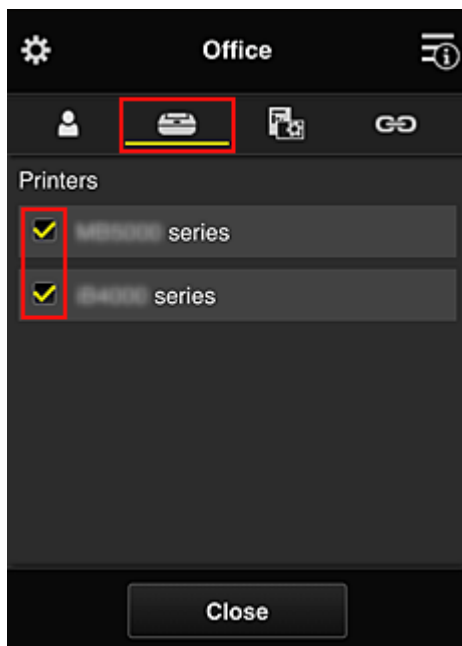

12. On **Apps** tab, set only Evernote app to ON

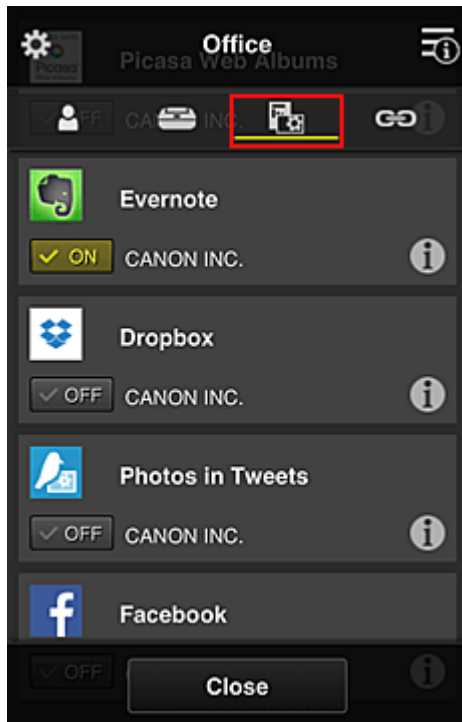

To switch between app registration/deletion, select ON / OFF.
To return to the **Group management** screen, select **Close**.

This completes the setup of the group to be used by the entire office.

»» Note

- The group setup screen displays all users and printers that are registered in the domain.
- If you want to set up new apps as an individual, you can add a group.
To create a new group, use **Add group**, and then in the setup screen for the added group, add users and printers.

- [Limiting Apps That Each User Can Use](#)
- [Limiting Apps That All Members Can Use on Printer](#)
- [Limiting Apps That Individual Users Can Use on Printer](#)
- [Limiting Printers That Individual Users Can Use](#)

»» Important

- The available apps may differ depending on the country or the region.

Limiting Apps That Each User Can Use

Set the following:

- Entire office: Use only Evernote app
- President: Use Evernote app and Facebook app

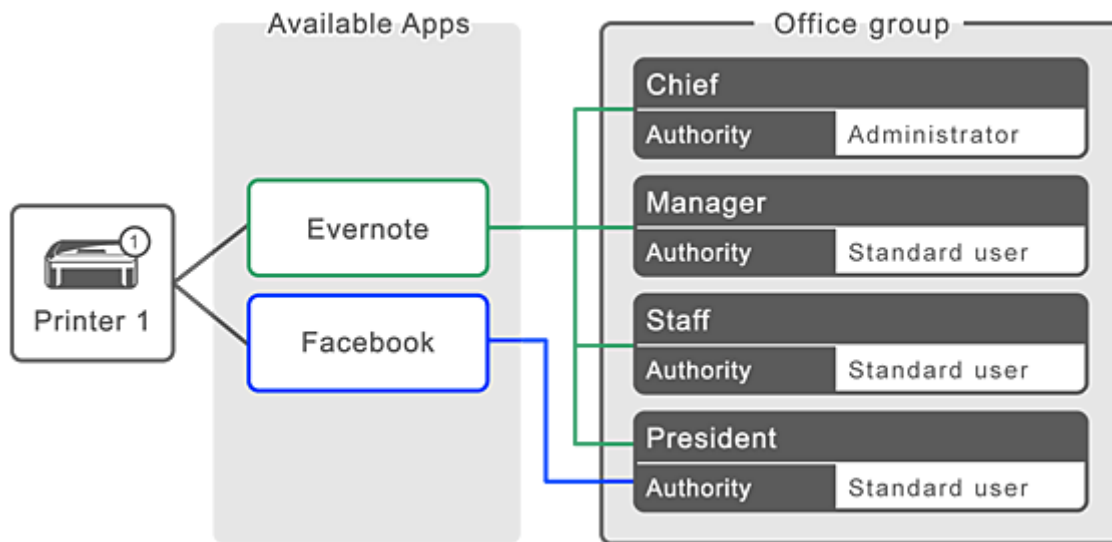

1. From , select **Group management**

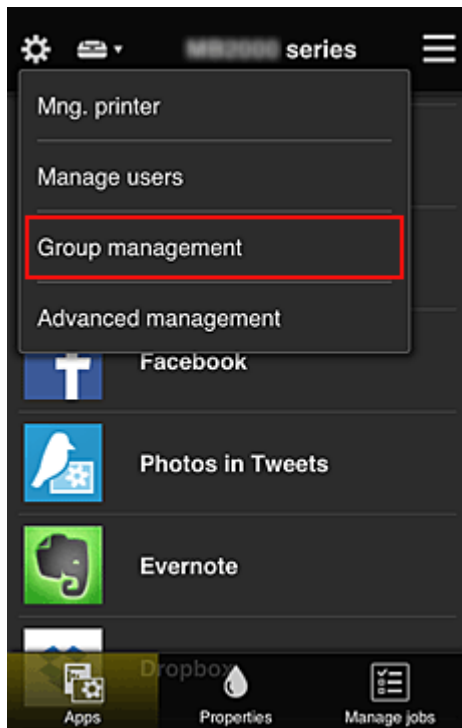

➤➤➤ Note

- This appears only if **Manage by group (for office users)** is set in **Advanced management**.

2. In displayed screen, select **Add group**

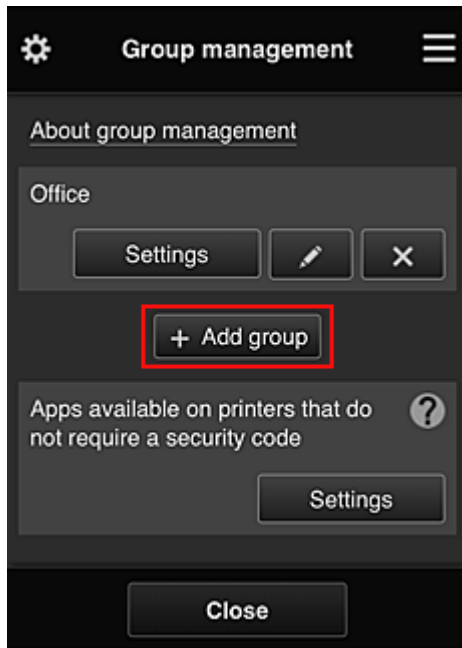

3. The senior clerk enters the **Group name** and selects **OK**

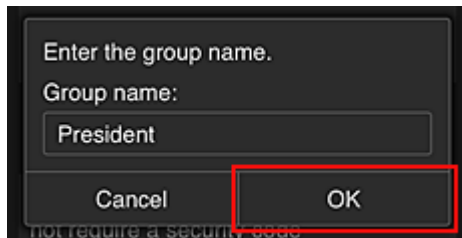

In this field, enter "President" as the president-only group because you will be setting apps that only the president can use.

»»» Important

- The following restrictions apply to entering the **Group name**.
 - The group name can have up to 20 single-byte alphanumeric characters or up to 10 double-byte characters.
 - The same group name cannot be registered more than once in the same domain.
 - Up to 20 groups can be registered.
- The person who created the group becomes the **Administrator**.

4. Follow messages displayed on screen, and select **OK**

The group setup screen appears.

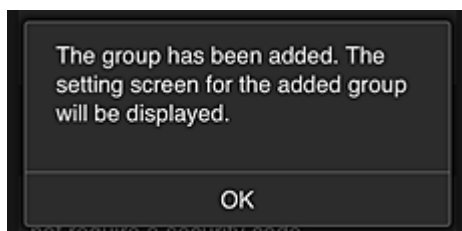

5. On **Users** tab, select only president

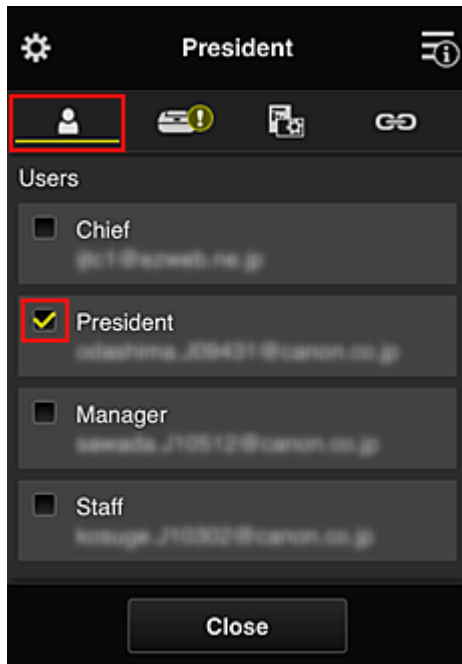

6. On the **Printers** tab, select printer to be used.

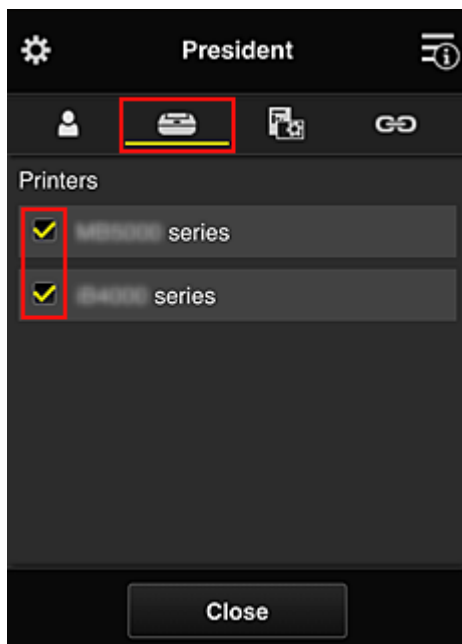

7. On the **Apps** tab, set the Evernote and Facebook apps to 

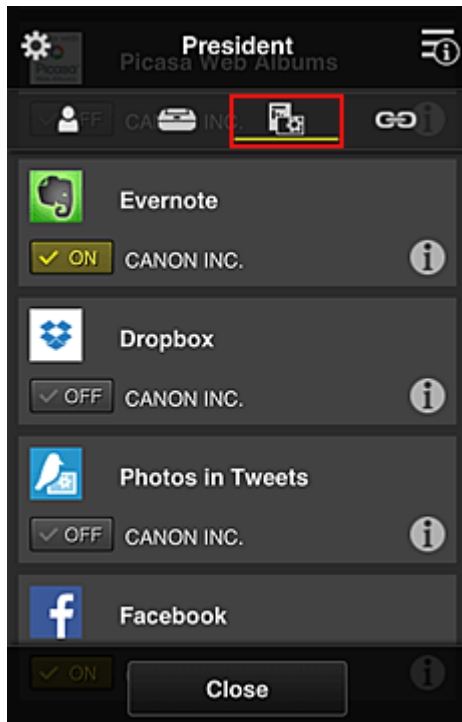

To switch between app registration/deletion, select ON / OFF.
To return to the **Group management** screen, select **Close**.

The above procedure allows you to set apps that only the president can use.

»» Note

- The group setup screen displays all users and printers that are registered in the domain.

Limiting Apps That All Members Can Use on Printer

To set the apps to be used on the printer, use the following procedure provided by this service.
As an example, this section describes the procedure for allowing all users to use the Evernote app from the printer.

1. From , select **Group management**

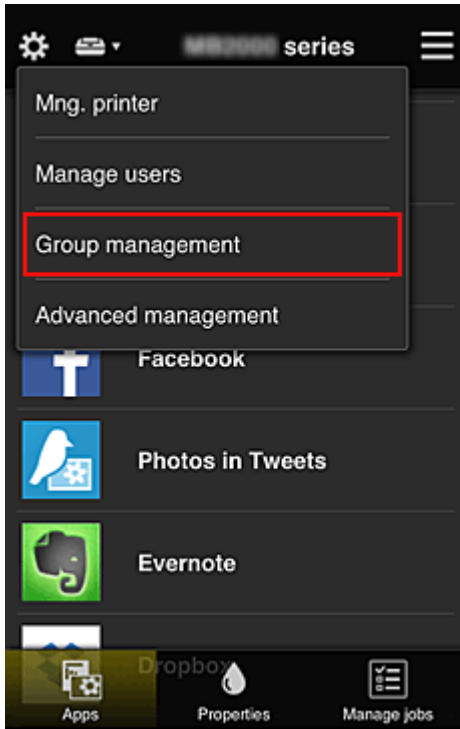

➤➤➤ **Note**

- This appears only if **Manage by group (for office users)** is set in **Advanced management**.

2. For **Apps** available on printers that do not require a security code, select **Settings**

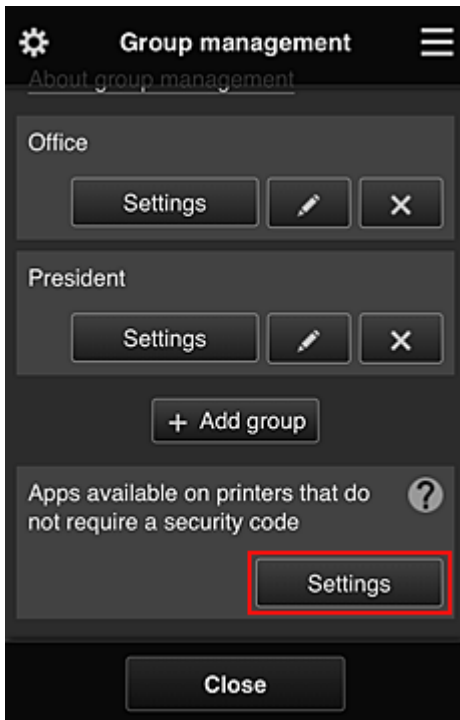

3. On **Apps** tab, set only Evernote app to 

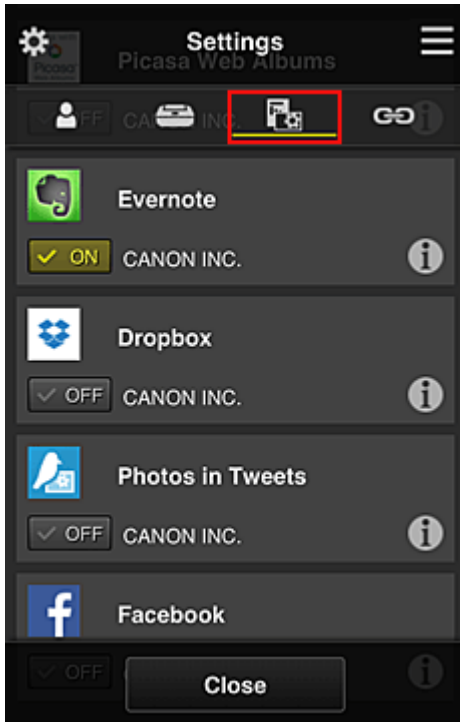

To switch between app registration/deletion, select ON / OFF.
 To return to the **Group management** screen, select **Close**.

The above procedure sets up Evernote as the only app that all users can use on the printer.

Limiting Apps That Individual Users Can Use on Printer

For each user, you can set the apps that the user can use on the printer. As an example, this section describes the procedure for allowing only the president to also use the Facebook app from the printer.

1. From , select **Advanced management**

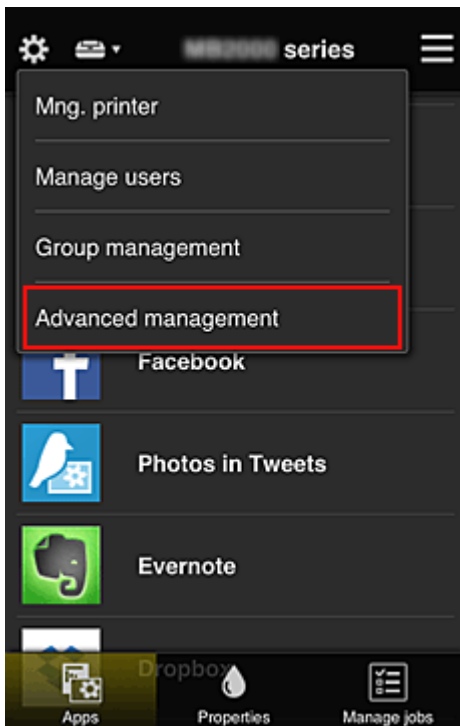

2. For **Require security code**, select **Set**.



3. Select printer for setting up **Security code**.

[Security codes](#) identify individual users when multiple users are using a printer.



➤➤➤ Note

- On models where the settings cannot be changed, this function cannot be selected. Some models do not support this function. To check whether your model supports this function, see "Models that Support Security Codes".

4. Set up **Security code**

If there are users who have not set up a **Security code**, a screen appears for checking whether to send an e-mail prompting those users to set up a **Security code**.

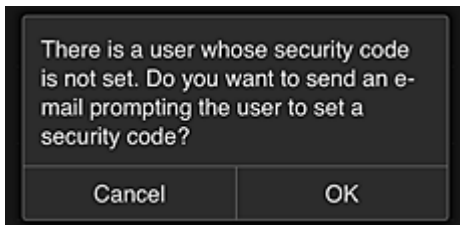

To send a notification e-mail only to users without a **Security code**, select **OK**.

To display the **Security code** setup screen when each user logs in and not send the notification e-mail, select **Cancel**.



»» Important

- The following character restriction applies to **Security code** entries:
 - Up to 8 alphanumeric characters

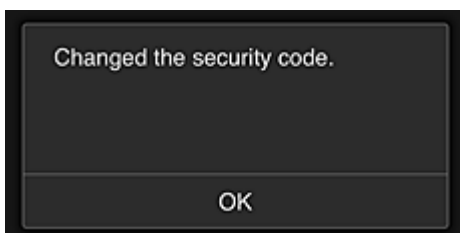

The **Security code** change process ends, and the change completion message appears. In the message screen, select **OK** to return to the main screen.

5. Select  **Cloud** from the printer's home screen

6. In **Switch user** screen, select user



7. Enter **Security code** that you set and **Log in**

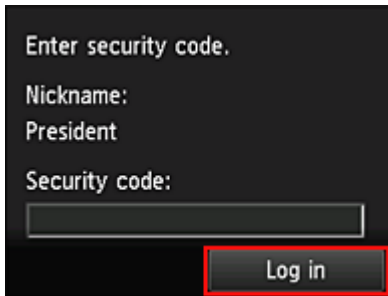

➤➤➤ **Note**

- If you have not set a **Security code**, set a **Security code** from [My account](#), and then **Log in**.

8. Select Facebook app

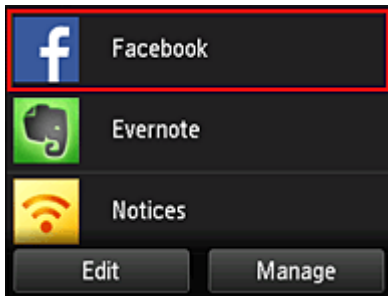

Only the president will be able to use the Facebook app from the printer.

Limiting Printers That Individual Users Can Use

As an example, this section describes the procedure for setting up one printer for the president and another printer for all users.

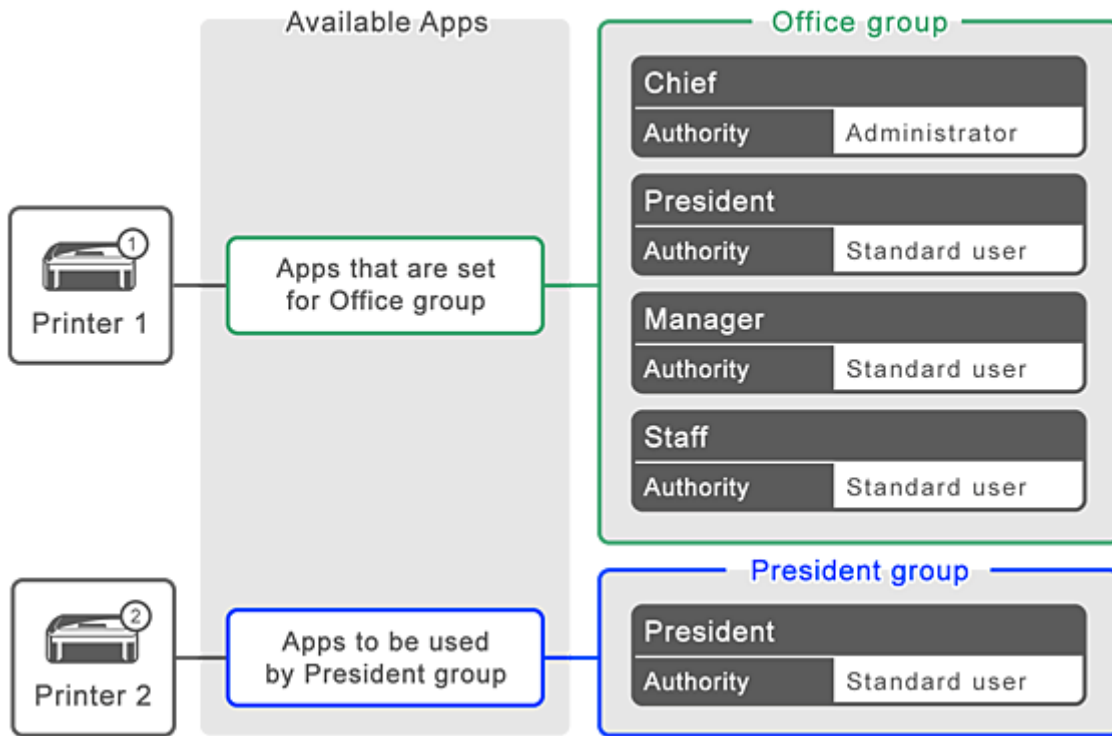

1. From , select **Group management**

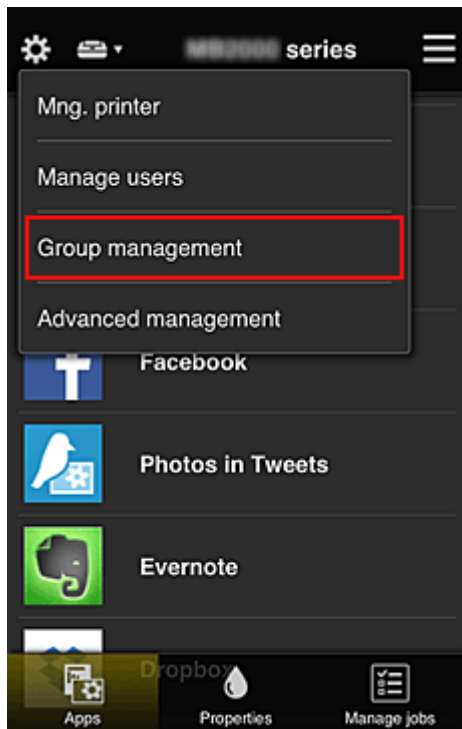

➤➤➤ **Note**

- This appears only if **Manage by group (for office users)** is set in **Advanced management**.

2. Select **Settings** for the group containing all users

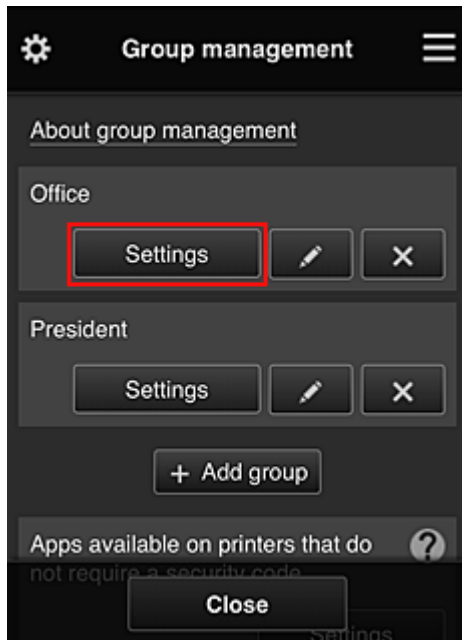

3. On the **Printers** tab, clear printer that was set up for president

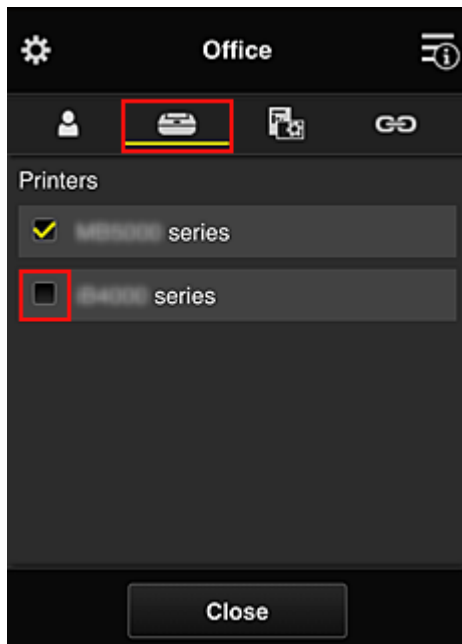

To return to the **Group management** screen, select **Close**.

»» Important

- If a user is being managed in multiple groups and an app is deleted or the target printer is changed for one of those groups, the user can still use that app or printer if the one of the other groups allows it.

Only the printer that was set can be used by all users.

What is a Security code?

A **Security code** identifies the user when multiple other users are sharing the same printer.

»» Important

- If you are using the MAXIFY series, you can set a **Security code**. We recommend that you set a **Security code** to prevent other users from using your account.
- This code is valid only when you use MAXIFY Cloud Link from the printer operation panel. You cannot use this code when you access the Canon Inkjet Cloud Printing Center from your smartphone, tablet, or computer.

Adding a Printer

With one account, you can use the Canon Inkjet Cloud Printing Center services on multiple printers.

The procedure for adding a printer is as follows:

- [If your model has color LCD monitor](#)
- [If your model has monochrome LCD monitor](#)
- [If your model has no LCD monitor/If you are using PRO-1000 series or PRO-500 series](#)

If your model has color LCD monitor

1. Check that an e-mail containing the URL has been sent to the registered e-mail address, and access the URL
2. Enter the information according to the instructions on the authentication screen, and then select **Log in**

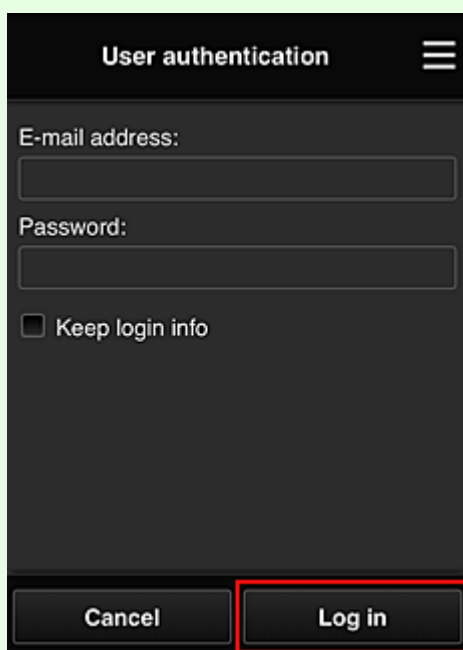

3. When printer addition complete message appears, select **OK**

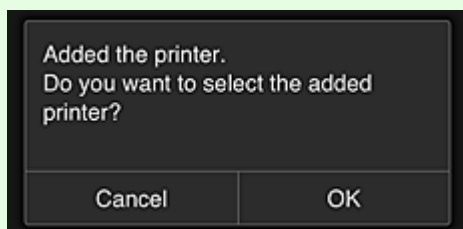

The printer addition process ends, and the main screen of Canon Inkjet Cloud Printing Center appears.

▶▶▶ Note

- If you select **Cancel**, the printer selection status does not change and the main screen of Canon Inkjet Cloud Printing Center appears.

If your model has monochrome LCD monitor If your model has no LCD monitor/If you are using PRO-1000 series or PRO-500 series

1. Check that an e-mail containing the URL has been sent to the registered e-mail address, and access the URL
 - If your model has monochrome LCD monitor
 - [If your model has no LCD monitor/If you are using PRO-1000 series or PRO-500 series](#)
2. Enter the information according to the instructions on the authentication screen, and then select **Log in**

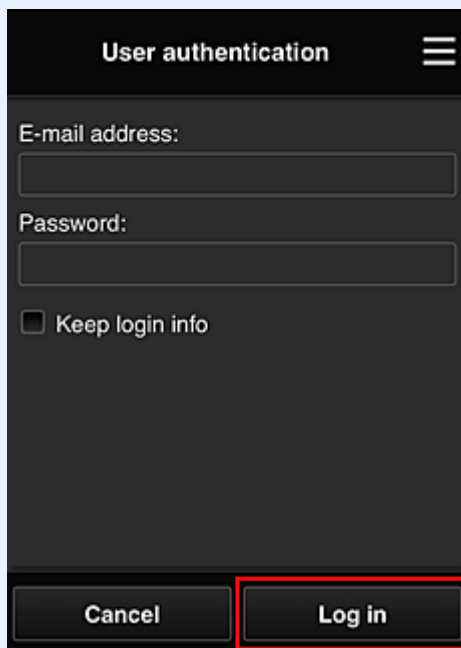

3. When printer addition complete message appears, select **OK**

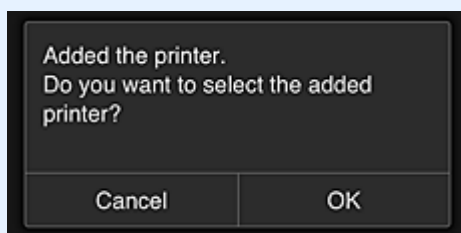

The printer addition process ends, and the main screen of Canon Inkjet Cloud Printing Center appears.

▶▶▶ Note

- If you select **Cancel**, the printer selection status does not change and the main screen of Canon Inkjet Cloud Printing Center appears.

■ [Adding a PIXMA/MAXIFY Cloud Link User](#)

Adding a PIXMA/MAXIFY Cloud Link User

Several people can use one printer.

This section describes the user addition procedure and the user privileges.

Adding a user

1. On the service screen, select **Manage users** from .

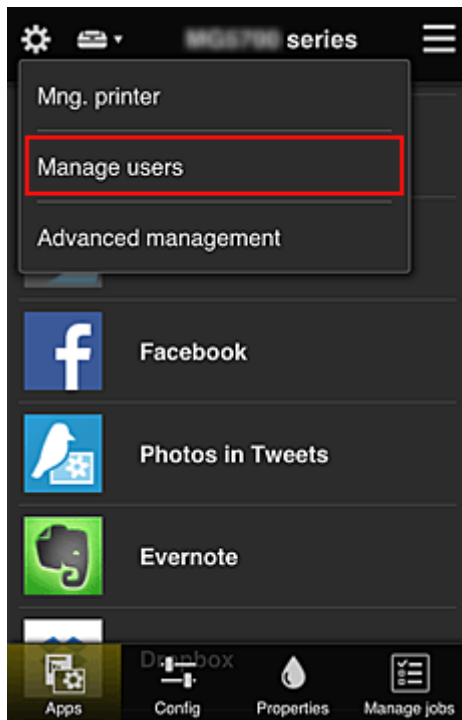

2. Select **Add user**

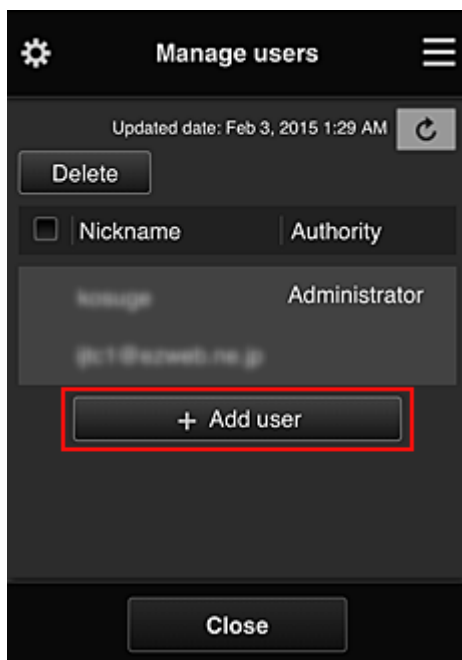

▶▶▶ Note

- When you select **Add user**, the service first checks whether the maximum number of users has been reached. If new users can be added, the user registration screen appears.

- The maximum number of users that can be added for 1 printer is 20.

3. Enter the e-mail address of the user to be added, and then select **OK**

The URL for completing the registration is then sent to the entered e-mail address.

►► **Note**

- If you enter an e-mail address that is already registered, you will receive notification that the address is registered. To specify another e-mail address, follow the displayed instructions.

4. Access the URL reported in the e-mail

The procedure that follows describes what to do if you receive a notification e-mail.

5. Read the terms displayed in the **License agreement** and **Privacy statement** screens. If you agree to the terms, select **Agree**.

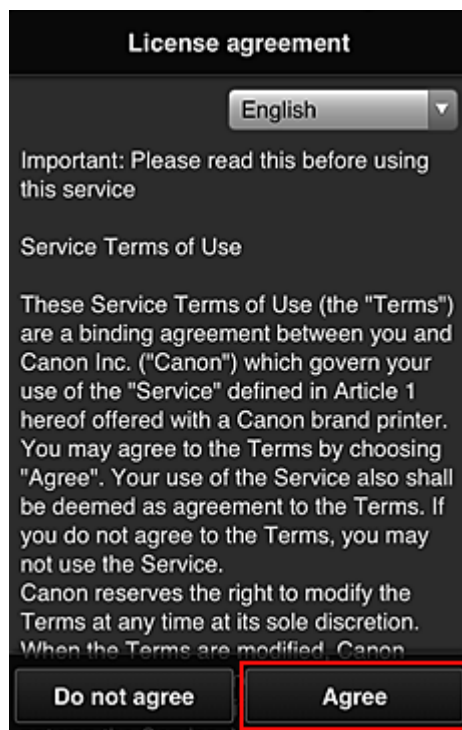

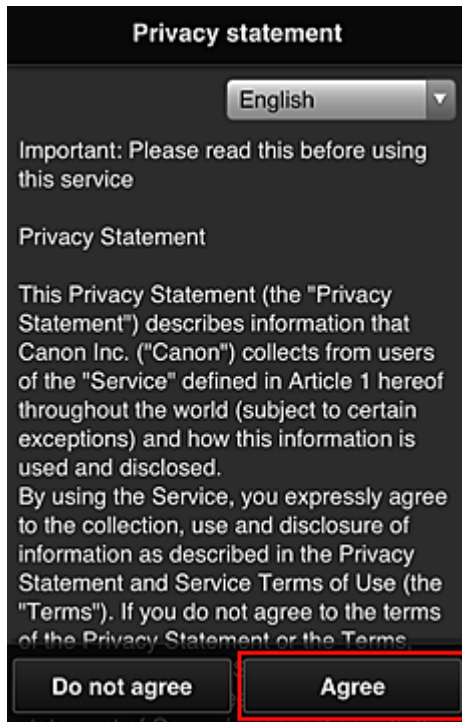

6. Register a password for logging in to the Canon Inkjet Cloud Printing Center.

On the My Account Registration screen, enter you desired password into **Password** and **Password (Confirmation)** and select **Next**.

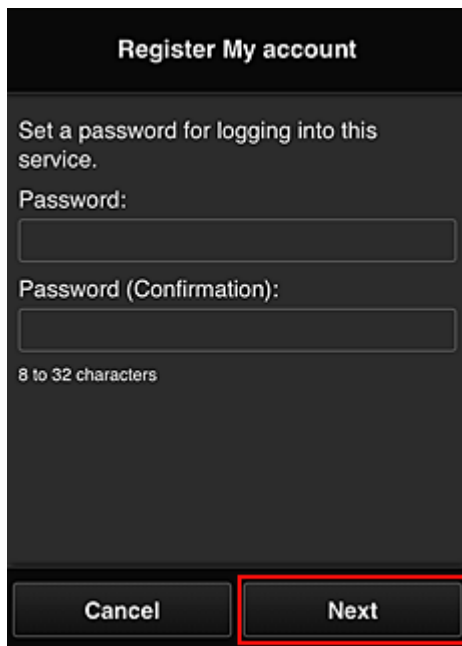

»» Important

- There are character restrictions for the **Password**, as shown below.
 - The password must be between 8 and 32 characters long, using single-byte alphanumeric characters and symbols (!"#%&'()*+,-./:;<=>@[¥]^_`{|}~). (Alphabets are case-sensitive)

7. Enter **Nickname**

Enter any user name that you want to use.

Register My account

Nickname:

1 to 20 characters

Time zone:

(UTC) Coordinated Universal Time

Back Done

»» Important

- The user name entry field has the following character restrictions:
 - The user name must be between 1 and 20 characters long, using single-byte alphanumeric characters and symbols (!"#\$\$%&'()*+,-./:;<=>@[¥]^_`{|}~). (Alphabets are case-sensitive)

8. Specify the **Time zone** setting, and select **Done**

Select your region on the list. If you cannot find your region on the list, select the one closest to your region.

Apply daylight saving time

This appears only when there is a daylight saving time in the **Time zone** that you selected. Select whether or not to apply the daylight saving time.

Register My account

Nickname:

1 to 20 characters

Time zone:

(UTC) Coordinated Universal Time

Back Done

The main registration is complete, and a registration completion e-mail is sent.

▶▶▶ Note

- When you use MAXIFY Cloud Link, a cookie for the selected user is added to the printer, and the login status of each user is recovered. For each printer, you can register cookies for up to 8 users.

Printer user privileges

If several users are using the cloud service for 1 printer, each user is categorized as the **Administrator** or a **Standard user**.

▶▶▶ Note

- The user who is registered first becomes the **Administrator**. The administrator can change the privileges of users from the [Manage users screen](#).

An **Administrator** can change printer information, add and delete apps, manage users, and perform various other operations.

A **Standard user** can check printer information and start apps.

For information about the functions that each user can use, refer to the "[Canon Inkjet Cloud Printing Center window](#)".

If you are using MAXIFY Cloud Link from the printer, select **Multiusers mode** in the [Mng. printer screen](#) to set the printer to **Multiusers mode**. Each user can then start an app and print documents.

▶▶▶ Note

- If you have not set your own **Security code**, select **Multiusers mode** to display the **Security code** setup screen.
If you select **Cancel**, you will not be able to set **Multiusers mode**.
- If you are the **Administrator**, a confirmation screen appears asking whether you want to send an e-mail prompting standard users without a **Security code** to set up their **Security code**.
 - To send a notification e-mail is sent only to users without a **Security code** and to set **Multiusers mode**, select **OK**.
 - To set **Multiusers mode** without sending a notification e-mail, select **Cancel**.

■ [Troubleshooting Canon Inkjet Cloud Printing Center](#)

Troubleshooting Canon Inkjet Cloud Printing Center

- [If an app cannot be installed](#)
- [If the registered app is not in the Apps list](#)
- [If the information is not updated when you press the update button](#)
- [If you do not receive the registration e-mail](#)
- [If you cannot print](#)
- [Printing starts on its own even if you do not do anything](#)
- [If you are unable to log in correctly even after entering the correct password in iOS or Mac](#)

If an app cannot be installed

Check the country or region where the printer was purchased.

If the printer is taken outside the country or region where it was purchased, apps cannot be installed.

If You Are Using iP110 series

Check the country or region where the printer was purchased.

If you take the printer outside the country or region where you purchased it, you may not be able to install certain apps.

You can continue to use apps that are already installed, as long as the apps support the country or region you are moving to.

If the registered app is not in the Apps list

Check the display language of Canon Inkjet Cloud Printing Center.

If the display language is switched to a language that does not support an app, the app will not be displayed in the apps list but will continue to be registered.

If you switch back to the target language of the app, it will be displayed in the apps list and you will be able to start, register, or unregister the app.

If the information is not updated when you press the update button



Because the Properties screen requires network connection with this product, the information may not be reflected immediately. Please wait awhile, and then try updating the information again.

If the information is still not updated, then check that the product is connected to the Internet.

If you do not receive the registration e-mail

You may have entered a different e-mail address during the user registration of Canon Inkjet Cloud Printing Center.

If your model has color LCD monitor

On the printer's Home screen, select  **Setup** ( Various settings) ->  **Web service setup** -> **Web service connection setup** -> **IJ Cloud Printing Center setup** -> **Delete from this service** to delete the service registration.

If your model has monochrome LCD monitor



On the printer operation panel, select the **Setup** button, and then select **Web service setup** -> **Connection setup** -> **IJCloudPrintingCtr** -> **Delete from service** to delete the service registration.

If your model has no LCD monitor

Displaying Printer Information -> **IJ Cloud Printing Center setup** -> **Delete from this service** to delete the service registration.

To display printer information, go to the *Online Manual* home page, and see "Checking Printer Information" for your model.

After resetting the printer, repeat the user registration of Canon Inkjet Cloud Printing Center from the beginning.

If you cannot print

Check the following if you cannot print.

If your model has color LCD monitor

- Check that the printer is connected to the Internet.
- Check that the printer is connected to a LAN and the LAN environment is connected to the Internet.
- Check that no error message is displayed on the printer's LCD monitor.
- If printing does not start even after you wait awhile, go to the printer's home screen, and select



Setup (



Various settings) -> **Web service inquiry**.

If your model has monochrome LCD monitor

- Check that the printer is connected to the Internet.
- Check that the printer is connected to a LAN and the LAN environment is connected to the Internet.
- Check that no error message is displayed on the printer's LCD monitor.

- If printing does not start even after you wait awhile, go to the printer operation panel, select **Setup**, and run **Web service inquiry**. If printing does not start, run the inquiry several times.



If your model has no LCD monitor

- Check that the printer is connected to the Internet.
- Check that the printer is connected to a LAN and the LAN environment is connected to the Internet.
- If printing does not start even after you wait awhile, first turn off the printer, and then turn it back on again.

If the problem is not resolved, use the printer driver from your computer to perform the print job and check whether the data can be printed normally on the printer.

If you still cannot print, see the troubleshooting page for your model on the Home of the *Online Manual*.



▶▶▶ Note

- With a wireless LAN connection, after the printer is turned on, it may take several minutes before communication is possible. Check that your printer is connected to the wireless network, and wait a while before you start printing.
- If the printer is not turned on or is not connected to the Internet, and consequently a print job is not processed within 24 hours after it was submitted, the print job is automatically canceled. If this happens, check the printer power and the Internet connection, and then re-submit the print job.

Printing starts on its own even if you do not do anything

A third party may be able to illegally use the Canon Inkjet Cloud Printing Center services.

If your model has color LCD monitor

On the printer's Home screen, select  **Setup** ( Various settings) ->  **Web service setup** -> **Web service connection setup** -> **IJ Cloud Printing Center setup** -> **Delete from this service** to delete the service registration.

If your model has monochrome LCD monitor

On the printer operation panel, select the  **Setup** button, and then select **Web service setup** -> **Connection setup** -> **IJCloudPrintingCtr** -> **Delete from service** to delete the service registration.

If your model has no LCD monitor

Displaying Printer Information -> **IJ Cloud Printing Center setup** -> **Delete from this service** to delete the service registration.

To display printer information, go to the *Online Manual* home page, and see "Checking Printer Information" for your model.

After resetting the printer, repeat the user registration of Canon Inkjet Cloud Printing Center from the beginning.

If you are unable to log in correctly even after entering the correct password in iOS or Mac

If you are using iOS or Mac and the password contains the ¥ or # symbol, enter a backslash instead. For instructions on entering a backslash, see the OS help.

Print Easily from a Smartphone or Tablet with Canon PRINT Inkjet/SELPHY

Use Canon PRINT Inkjet/SELPHY to easily print photos saved on a smartphone or tablet (iOS or Android) wirelessly.

Canon PRINT Inkjet/SELPHY can be downloaded from App Store and Google Play.



Printing with Windows RT

When you use Windows RT 8.1 or a later version, printing is easy because you simply connect this printer to the network.

For information about connecting to the network, see the setup URL (<http://www.canon.com/ijsetup>) for using this product from your computer, smartphone, or tablet device.

When the connection is complete, the Canon Inkjet Print Utility software, which allows you to specify detailed print settings, is downloaded automatically.

By using Canon Inkjet Print Utility, you can check the **Printer status** and specify detailed print settings. (The available functions will differ depending on your usage environment and connection method.)

Handling and Use of Paper

► Paper

- Media Types You Can Use
- Paper Load Limit
- Media Types You Cannot Use
- Handling Paper
- Before Printing on Art Paper

► Handling Paper

- Paper Sources to Load Paper
- Loading Paper in the Rear Tray
- Loading Paper in the Manual Feed Tray

Paper

- ▶ **Media Types You Can Use**
- ▶ **Paper Load Limit**
- ▶ **Media Types You Cannot Use**
- ▶ **Handling Paper**
- ▶ **Before Printing on Art Paper**

Media Types You Can Use

To get the best printing result, choose paper suitable for printing. Canon provides various types of paper suitable for documents as well as paper suitable for photos or illustrations. We recommend the use of Canon genuine paper for printing your important photos.

Media Types

Commercially available papers

- Plain Paper (including recycled paper)

Canon genuine papers

The Model Number of Canon genuine paper is shown in brackets. Refer to the instruction manual supplied with the paper for detailed information on the printable side and notes on handling paper. For information on the page sizes available for each Canon genuine paper, access our website.

►► Note

- You may not be able to purchase some Canon genuine papers depending on the country or region of purchase. Paper is not sold in the US by Model Number. Purchase paper by name.

Paper for printing documents:

- Canon Red Label Superior <WOP111>
- Canon Océ Office Colour Paper <SAT213>

Paper for printing photos:

- Photo Paper Pro Platinum <PT-101>
- Photo Paper Plus Glossy II <PP-201>
- Photo Paper Pro Luster <LU-101>
- Photo Paper Plus Semi-gloss <SG-201>
- Matte Photo Paper <MP-101>^{*1*2}
- Photo Paper Pro Premium Matte <PM-101>^{*1*2}

*1 Printing to this paper from a PictBridge (Wireless LAN) compliant device is not supported.

*2 For printing area, see [Sizes for 0.98 inch \(25 mm\) Margin Paper](#).

■ [Paper Load Limit](#)

■ Paper Settings on the Printer Driver and the Printer (Media Type) (Windows)

■ [Paper Settings on the Printer Driver and the Printer \(Media Type\)](#) (Mac OS)

►► Note

- When printing photos saved on a PictBridge (Wireless LAN) compliant device, you must specify the page size and media type.

■ [Printing from a Digital Camera](#)

- When using art paper, see [Before Printing on Art Paper](#).

Page Sizes

You can use the following page sizes.

►► Note

- You can load the page sizes as follows.
 - rear tray: A5, A4, A3, A3+, A2, B5, B4, B3, Letter, Legal, 4" x 6" (10 x 15 cm), 5" x 7" (13 x 18 cm), 8" x 10" (20 x 25 cm), 10" x 12" (25 x 30 cm), 11" x 17" (28 x 43 cm), 14" x 17" (36 x 43 cm), 17" x 22" (43 x 56 cm)
 - manual feed tray: A4, A3, A3+, A2, B4, B3, Letter, Legal, 8" x 10" (20 x 25 cm), 10" x 12" (25 x 30 cm), 11" x 17" (28 x 43 cm), 14" x 17" (36 x 43 cm), 17" x 22" (43 x 56 cm)
- Printing on the following page sizes from a PictBridge (Wireless LAN) compliant device is not supported.
 - A5, B5, B4, B3, Legal, 10" x 12" (25 x 30 cm), 11" x 17" (28 x 43 cm), 14" x 17" (36 x 43 cm)

Standard sizes:

- A5, A4, A3, A3+, A2
- B5, B4, B3
- Letter, Legal
- 4" x 6" (10 x 15 cm), 5" x 7" (13 x 18 cm), 8" x 10" (20 x 25 cm), 10" x 12" (25 x 30 cm), 11" x 17" (28 x 43 cm), 14" x 17" (36 x 43 cm), 17" x 22" (43 x 56 cm)

Non-standard sizes:

You can print on non-standard size paper within the following ranges.

- rear tray
 - Minimum size: 3.50 x 5.00 inches (89.0 x 127.0 mm)
 - Maximum size: 17.00 x 23.39 inches (432.0 x 594.0 mm)
- manual feed tray
 - Minimum size: 8.00 x 10.00 inches (203.2 x 254.0 mm)
 - Maximum size: 17.00 x 23.39 inches (432.0 x 594.0 mm)

Paper Weight / Thickness

You can use paper in the following weight/thickness ranges.

* Do not use paper heavier or thicker than this, as it could jam in the printer.

- rear tray
 - Plain paper: From 17 to 28 lb (64 to 105 g /m²)
 - Specialty paper: Up to 80 lb (300 g /m²) / from 4 to 11.8 mil (0.1 to 0.3 mm)
- manual feed tray
 - Specialty paper: Up to 107 lb (400 g /m²) / from 4 to 27.6 mil (0.1 to 0.7 mm)

Paper Load Limit

►► Important

- When performing color calibration, load all types of paper in the rear tray regardless of the paper sources shown in the tables below.

Commercially Available Papers

Media Name	Rear Tray	Manual Feed Tray	Paper Output Tray
Plain Paper (including recycled paper)* ¹	Approx. 150 sheets (20 sheets: A2)	N/A* ²	Approx. 50 sheets (20 sheets: A2)

Canon Genuine Papers

►► Note

- We recommend that you remove the previously printed sheet from the paper output tray before continuously printing to avoid blurs and discoloration (except for Canon Red Label Superior <WOP111> and Canon Océ Office Colour Paper <SAT213>).

Paper for printing documents:

Media Name	Rear Tray	Manual Feed Tray	Paper Output Tray
Canon Red Label Superior <WOP111>	Approx. 120 sheets	N/A* ²	Approx. 50 sheets
Canon Océ Office Colour Paper <SAT213>	Approx. 100 sheets	N/A* ²	Approx. 50 sheets

Paper for printing photos:

Media Name <Model No.>	Rear Tray	Manual Feed Tray
Photo Paper Pro Platinum <PT-101>* ³	1 sheet: A2 10 sheets: A4, A3, A3+, Letter, 8" x 10" (20 x 25 cm) 20 sheets: 4" x 6" (10 x 15 cm)	1 sheet: A4, A3, A3+, A2, Letter, 8" x 10" (20 x 25 cm)
Photo Paper Plus Glossy II <PP-201>* ³	10 sheets: A4, A3, A3+, Letter, 5" x 7" (13 x 18 cm), 8" x 10" (20 x 25 cm) 20 sheets: 4" x 6" (10 x 15 cm)	1 sheet: A4, A3, A3+, Letter, 8" x 10" (20 x 25 cm)
Photo Paper Pro Luster <LU-101>* ³	1 sheet: A2, 17" x 22" (43 x 56 cm) 10 sheets: A4, A3, A3+, Letter	1 sheet: A4, A3, A3+, A2, Letter, 17" x 22" (43 x 56 cm)
Photo Paper Plus Semi-gloss <SG-201>* ³	1 sheet: 17" x 22" (43 x 56 cm)	1 sheet: A4, A3, A3+, Letter, 8" x 10" (20 x 25 cm), 17" x 22" (43 x 56 cm)

	10 sheets: A4, A3, A3+, Letter, 5" x 7" (13 x 18 cm), 8" x 10" (20 x 25 cm) 20 sheets: 4" x 6" (10 x 15 cm)	
Matte Photo Paper <MP-101>	10 sheets: A4, A3, A3+, Letter 20 sheets: 4" x 6" (10 x 15 cm)	1 sheet: A4, A3, A3+, Letter
Photo Paper Pro Premium Matte <PM-101>	N/A*4	1 sheet: A4, A3, A3+, A2, Letter, 17" x 22" (43 x 56 cm)

*1 Proper feeding of paper may not be possible at the maximum capacity depending on the type of paper or environmental conditions (either very high or low temperature or humidity). In such cases, reduce the number of paper you load at a time to less than half.

*2 Feeding paper from the manual feed tray can damage the printer. Always load in the rear tray.

*3 When loading paper in stacks, the print side may become marked as it is fed or paper may not feed properly. In this case, load one sheet at a time.

*4 Feeding paper from the rear tray can damage the printer. Always load in the manual feed tray.

►► Note

- When using non-Canon genuine specialty paper, load one sheet at a time in the rear tray or manual feed tray.

Media Types You Cannot Use

Do not use the following types of paper. Using such paper will cause not only unsatisfactory results, but also the printer to jam or malfunction.

- Folded, curled, or wrinkled paper
- Damp paper
- Paper that is too thin

rear tray

- Plain paper: Less than 17 lb (64 g /m²)
- Specialty paper: Less than 4 mil (0.1 mm)

manual feed tray

- Specialty paper: Less than 4 mil (0.1 mm)

- Paper that is too thick

rear tray

- Plain paper: More than 28 lb (105 g /m²)
- Specialty paper: More than 80 lb (300 g /m²) or more than 11.8 mil (0.3 mm)

manual feed tray

- Specialty paper: More than 107 lb (400 g /m²) or more than 27.6 mil (0.7 mm)

- Plain paper or notepad paper cut to a small size (when printing on paper smaller than A5)
- Picture postcards
- Postcards affixed with photos or stickers
- Envelopes
- Any type of paper with holes
- Paper that is not rectangular
- Paper bound with staples or glue
- Paper with adhesives
- Paper decorated with glitter, etc.
- Do not use the following types of Canon genuine paper.
 - Glossy Photo Paper "Everyday Use" <GP-501/GP-601>
 - Photo Paper Glossy <GP-601>
 - Fine Art Paper "Museum Etching" <FA-ME1>
 - High Resolution Paper <HR-101N>

Handling Paper

- Be careful not to rub or scratch the surfaces of any types of paper when handling.
- Hold the paper as closely as possible to its edges and try not to touch the printing surface. The print quality may be degraded if the printing surface is smudged with sweat or oil that comes from your hands.
- Do not touch the printed surface until the ink is dried. Even when the ink is dried, be careful not to touch the printed surface as much as possible when handling. Due to the nature of the pigment ink, the ink on the printed surface may be removed when being rubbed or scratched.
- Take out only the necessary number of paper from the package, just before printing.
- To avoid curling, when you do not print, put unused paper back into the package and keep it on a level surface. And also, store it avoiding heat, humidity, and direct sunlight.

Printing on Photo Paper

When printing under low temperature or humidity conditions, ink mist may stain the margins of paper due to static electricity.

To prevent this, it is recommended to use photo paper at a temperature of 68 °F (20 °C) or higher with a humidity of 20 % or more. If the temperature is lower than 68 °F (20 °C), it is recommended to use photo paper at a humidity of 40 % or more.

Before Printing on Art Paper

When using art paper, dust is liable to be generated. It is therefore recommended that paper dust be removed on art paper just before printing.

You will need a soft hair brush (or similar brush used to clean office automation equipment).

The wider the brush, the more effective it will be.



OK - soft brush made from material such as polypropylene, polyethylene, horse hair or goat hair.

►► Important

- Be sure not to use brushes as shown below. The printing surface may be damaged.



Not OK - brush made from hard material, cloth or washcloth, sticky and abrasive materials.

Paper dust removal procedure:

1. Check that the brush is not wet and free from dust or dirt.
2. Brush the overall printing surface carefully in one direction.

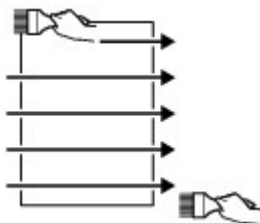

►► Important

- Be sure to brush all the way across the paper; do not start brushing at the middle or stop halfway.
- Be careful not to touch the printing surface as much as possible.

3. To complete the removal of paper dust, brush the paper in the other direction from top to bottom.

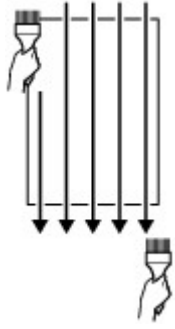

Handling Paper

- ▶ **Paper Sources to Load Paper**
- ▶ **Loading Paper in the Rear Tray**
- ▶ **Loading Paper in the Manual Feed Tray**

Paper Sources to Load Paper

The printer has two paper sources for feeding paper, the rear tray (A) and manual feed tray (B).

The paper source used depends on the page size and media type.

■ [Media Types You Can Use](#)

▶▶▶ Note

- When printing, select the correct page size, media type, and paper source. If you select the wrong page size or media type, the printer may not print with the proper print quality.

For details on how to load paper in each paper source, see below.

■ [Loading Paper in the Rear Tray](#)

■ [Loading Paper in the Manual Feed Tray](#)

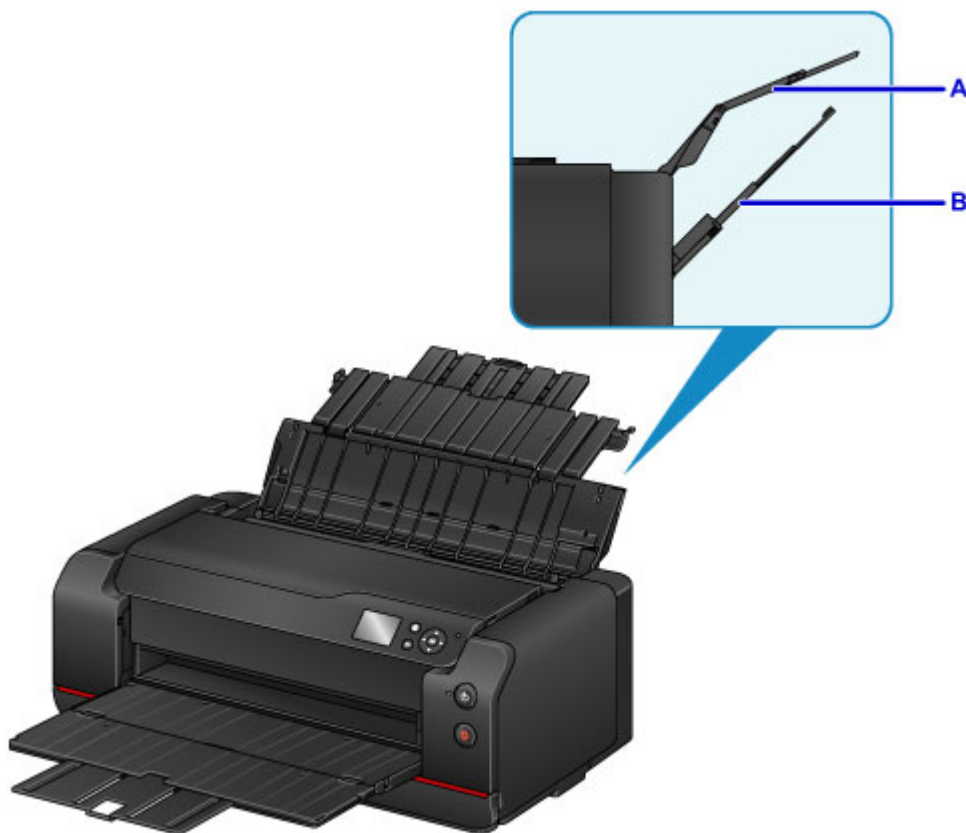

Loading Two or More Sheets of Paper in the rear tray

When printing on various sizes of paper from 4" x 6" (10 x 15 cm) to A2, load them in the rear tray (A). Two or more sheets of the same size and media type can be loaded at a time, allowing you to print continuously. (Some page sizes or media types can be loaded only one sheet at a time.)

Loading One Sheet of Large Size Paper or Thick Paper in the manual feed tray

When printing on large size paper from 8" x 10" (20 x 25 cm) to A2, or thick paper such as art paper, load it in the manual feed tray (B).

The manual feed tray does not accept plain paper. When printing on plain paper, load it in the rear tray.

Loading Paper in the Rear Tray

You can load multiple sheets of paper of the same type and size in the rear tray.

►► Important

- If you cut plain paper into small size such as 4" x 6" (10 x 15 cm) or 5" x 7" (13 x 18 cm) to perform trial print, it can cause paper jams.

►► Note

- The rear tray accepts the following page sizes.
 - A5, A4, A3, A3+, A2
 - B5, B4, B3
 - Letter, Legal
 - 4" x 6" (10 x 15 cm), 5" x 7" (13 x 18 cm), 8" x 10" (20 x 25 cm), 10" x 12" (25 x 30 cm), 11" x 17" (28 x 43 cm), 14" x 17" (36 x 43 cm), 17" x 22" (43 x 56 cm)

- We recommend Canon genuine photo paper for printing photos.

For details on the Canon genuine paper, see [Media Types You Can Use](#).

- You can use general copy paper or Canon Red Label Superior WOP111/Canon Océ Office Colour Paper SAT213.

For the page size and paper weight you can use for this printer, see [Media Types You Can Use](#).

- Print in an environment (temperature and humidity) suitable to the paper in use. For the temperature and humidity conditions of Canon genuine papers, refer to the paper's packaging or the supplied instructions.

1. Prepare paper.

Align the edges of paper. If paper is curled, flatten it.

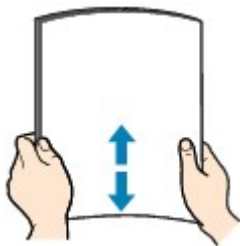

►► Note

- Align the edges of paper neatly before loading. Loading paper without aligning the edges may cause paper jams.
- If paper is curled, hold the curled corners and gently bend them in the opposite direction until the paper becomes completely flat.

For details on how to flatten curled paper, see "Load the paper after correcting its curl." in [Paper Is Smudged / Printed Surface Is Scratched](#).

- When using Photo Paper Plus Semi-gloss SG-201, even if the sheet is curled, load one sheet at a time as it is. If you roll up this paper to flatten, this may cause cracks on the surface of the paper and reduce the print quality.

2. Open the paper support (A) of the rear tray, then extend the paper support extension (B).

3. Open the paper output tray (C) gently.

4. Open the output tray extension (D), then pull out the paper output support (E).

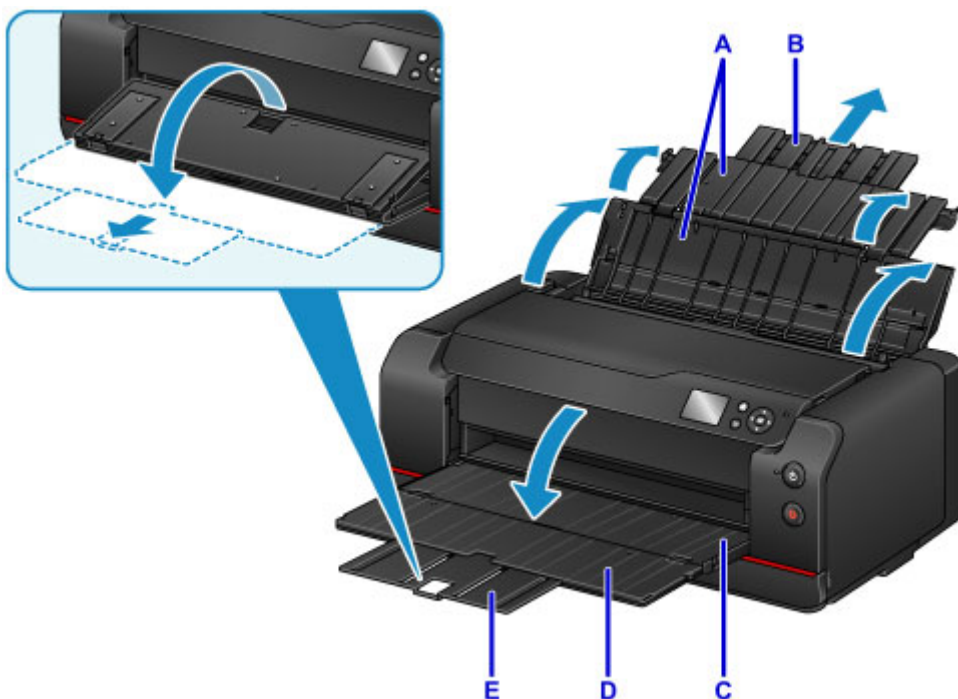

5. Open the feed slot cover (F).

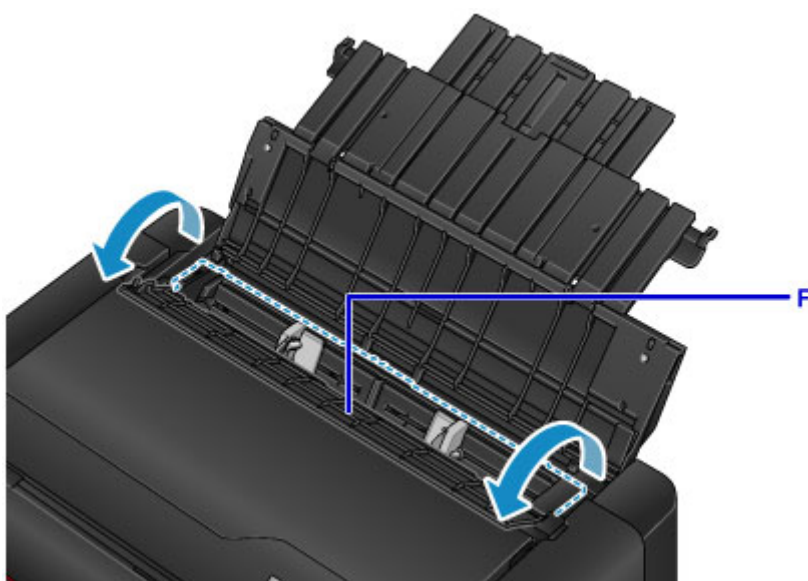

6. Slide the paper guides (G) to open them, and load the paper in the center of the rear tray WITH THE PRINT SIDE FACING YOU.

7. Slide the paper guides (G) to align them with both sides of the paper stack.

Do not slide the paper guides too hard against the paper. The paper may not be fed properly.

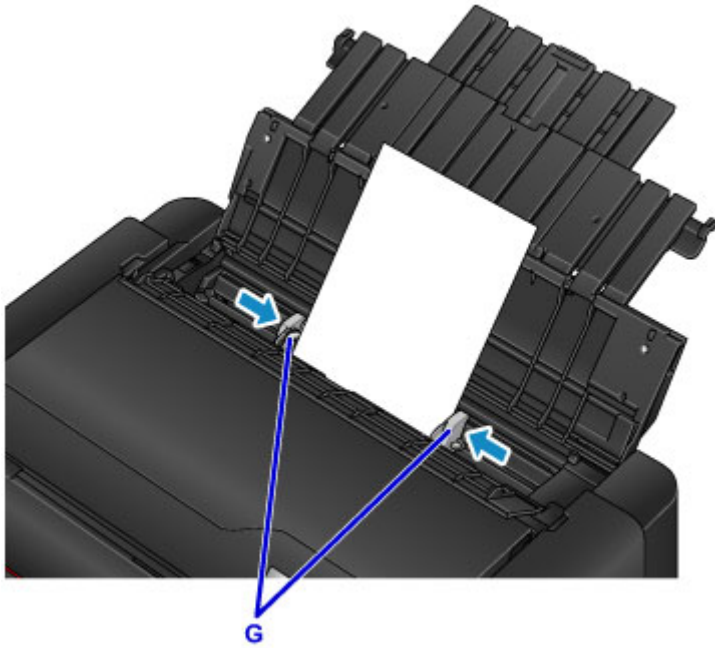

▶▶ Important

- Always load paper in the portrait orientation (H). Loading paper in the landscape orientation (I) can cause paper jams.

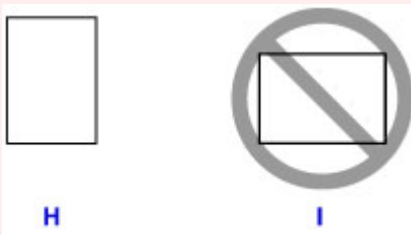

▶▶ Note

- Do not load sheets of paper higher than the load limit mark (J).
- The raised parts (K) on the paper guides retract depending on the size of the loaded paper. Do not push these parts down with your finger.

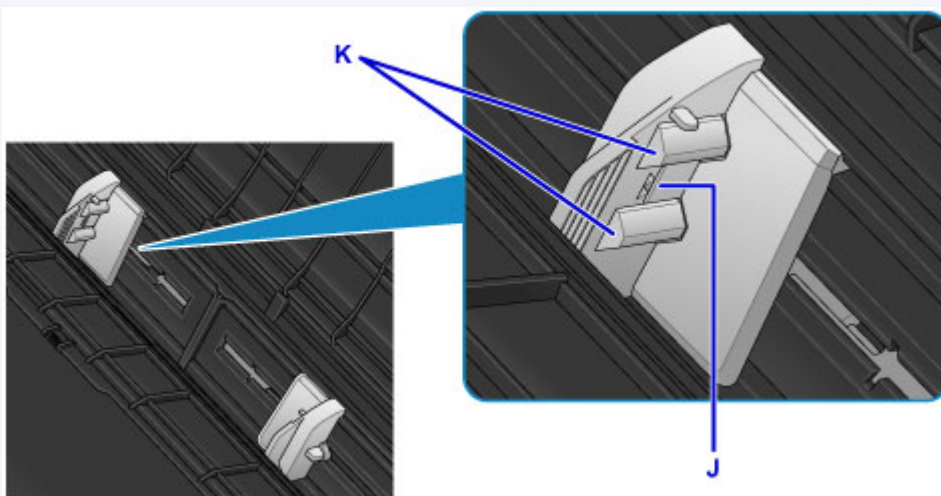

8. Close the feed slot cover gently.

The paper information registration screen for the rear tray is displayed on the LCD.

▶▶▶ Important

- If the feed slot cover is open, paper cannot be fed. Be sure to close the feed slot cover.

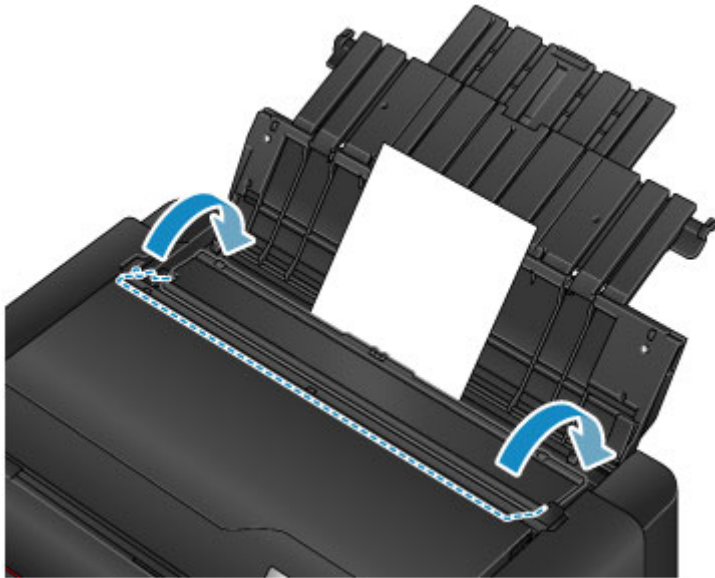

9. Select the size and type of paper loaded in the rear tray at **Page size** and **Type**, select **Register**, then press the **OK** button.

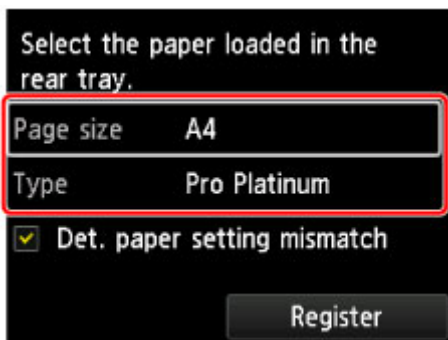

If a message is displayed on the screen, follow the directions in the message to complete registration.

■ [Paper Settings](#)

▶▶▶ Note

- When printing, select the rear tray for the paper source and the size and type of the loaded paper on the print settings screen of the printer driver.

Loading Paper in the Manual Feed Tray

You can load one sheet of 8" x 10" (20 x 25 cm) size paper or larger in the manual feed tray at a time.

►► Note

- The manual feed tray accepts the following page sizes.
 - A4, A3, A3+, A2
 - B4, B3
 - Letter, Legal
 - 8" x 10" (20 x 25 cm), 10" x 12" (25 x 30 cm), 11" x 17" (28 x 43 cm), 14" x 17" (36 x 43 cm), 17" x 22" (43 x 56 cm)
- We recommend Canon genuine photo paper for printing photos.
For details on the Canon genuine paper, see [Media Types You Can Use](#).
- Print in an environment (temperature and humidity) suitable to the paper in use. For the temperature and humidity conditions of Canon genuine papers, refer to the paper's packaging or the supplied instructions.
- The manual feed tray does not accept plain paper. When printing on plain paper, load it in the rear tray.
- When printing on paper from a PictBridge (Wireless LAN) compliant device, load paper in the rear tray.

■ [Printing from Digital Camera](#)

1. Prepare paper.

If paper is curled, flatten it.

►► Note

- If paper is curled, hold the curled corners and gently bend them in the opposite direction until the paper becomes completely flat.
For details on how to flatten curled paper, see "Load the paper after correcting its curl." in [Paper Is Smudged / Printed Surface Is Scratched](#).
- When using Photo Paper Plus Semi-gloss SG-201, even if the sheet is curled, load one sheet at a time as it is. If you roll up this paper to flatten, this may cause cracks on the surface of the paper and reduce the print quality.

2. Open the manual feed tray (A), then extend the paper support (B) and the paper support extension (C).

3. Open the paper output tray (D) gently.

4. Open the output tray extension (E), then pull out the paper output support (F).

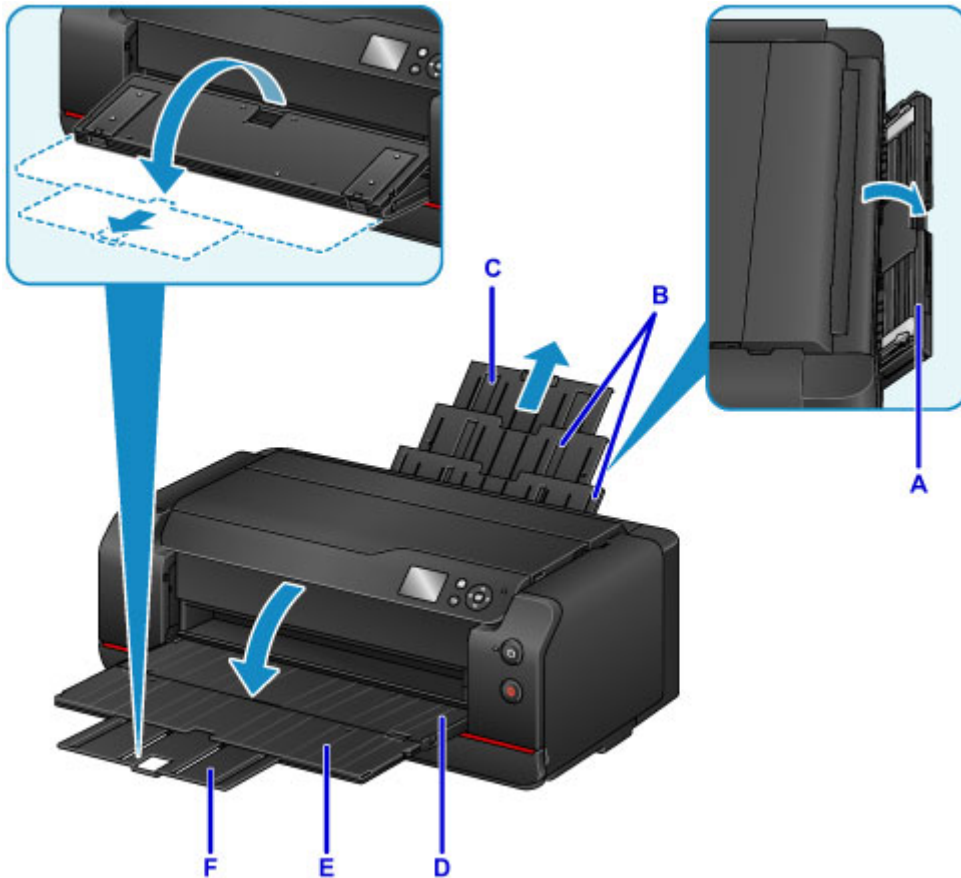

- Slide the paper guides (G) to open them, and load ONLY ONE SHEET OF PAPER in the center of the manual feed tray WITH THE PRINT SIDE FACING YOU.
- Slide the paper guides (G) to align them with both sides of the paper stack.
Do not slide the paper guides too hard against the paper. The paper may not be fed properly.

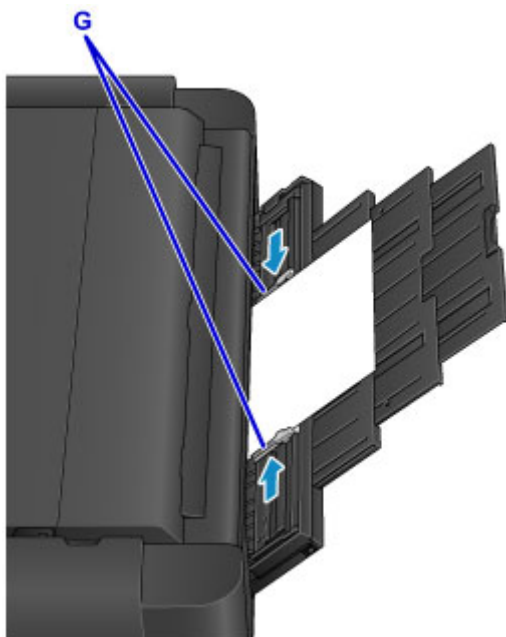

»» Important

- Always load paper in the portrait orientation (H). Loading paper in the landscape orientation (I) can cause paper jams.

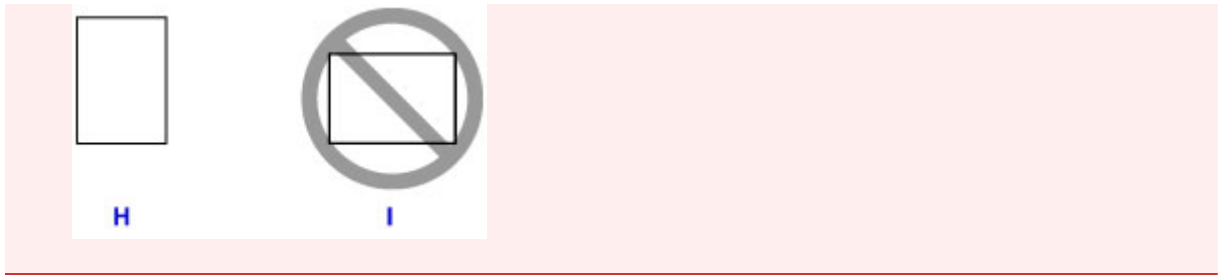

7. Check if the paper is set properly in the manual feed tray.

Make sure that the paper is set firmly against the bottom of the manual feed tray and against the paper guides by slightly jiggling the paper up and down.

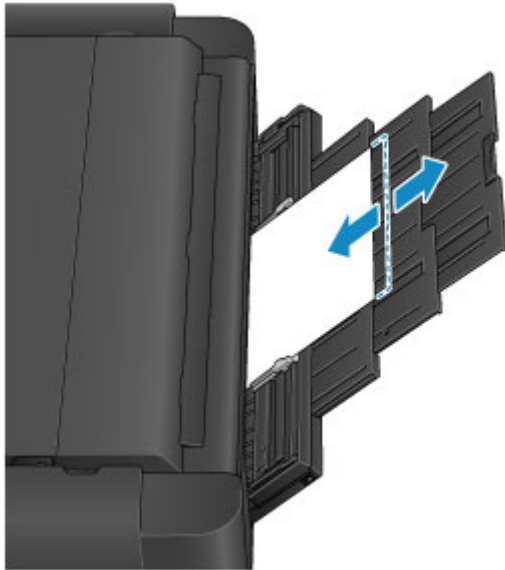

▶▶ Note

- When printing, select the manual feed tray for the paper source and the size and type of the loaded paper on the print settings screen of the printer driver.
- To continue printing from the manual feed tray, wait until printing is complete, then load the next sheet.

Making Settings from Operation Panel or Web Browser

- ▶ **Operation Panel**
- ▶ **LCD and Operation Panel**
- ▶ **Changing Settings from Operation Panel/Web Browser**
 - Changing Settings from Operation Panel
 - Changing Printer's Setting Using Web Browser

Operation Panel

* All lamps on the operation panel are shown lit in the figure below for explanatory purposes.

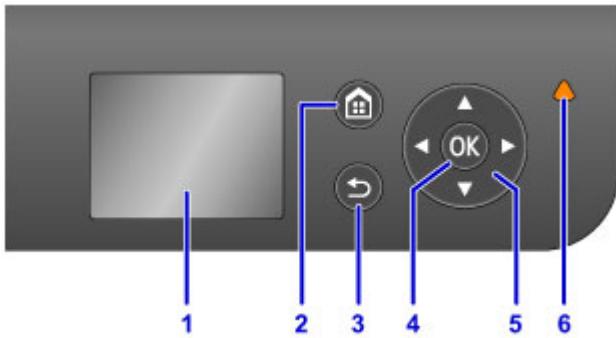

(1) LCD (Liquid Crystal Display)

Displays messages, menu items, and the operational status.

(2) HOME button

Used to display the HOME screen.

■ [LCD and Operation Panel](#)

(3) Back button

Returns the LCD to the previous screen.

(4) OK button

Finalizes the selection of a menu or setting item. This button is also used to resolve an error.

(5) ▲, ▼, ◀, and ▶ buttons

Used to select a menu or setting item.

■ [LCD and Operation Panel](#)

(6) Alarm lamp

Lights or flashes when an error occurs.

LCD and Operation Panel

You can select such functions as maintenance jobs and printer settings in the HOME screen on the LCD.

The functions on the HOME screen can be selected by using the ▲ or ▼ button (A) and pressing the **OK** button (B).

In the menu screen or settings screen, use the ▲, ▼, ◀, or ▶ button (C) to select a menu item or option, then press the **OK** button (B) to proceed with the procedure.

To return to the previous screen, press the **Back** button (D).

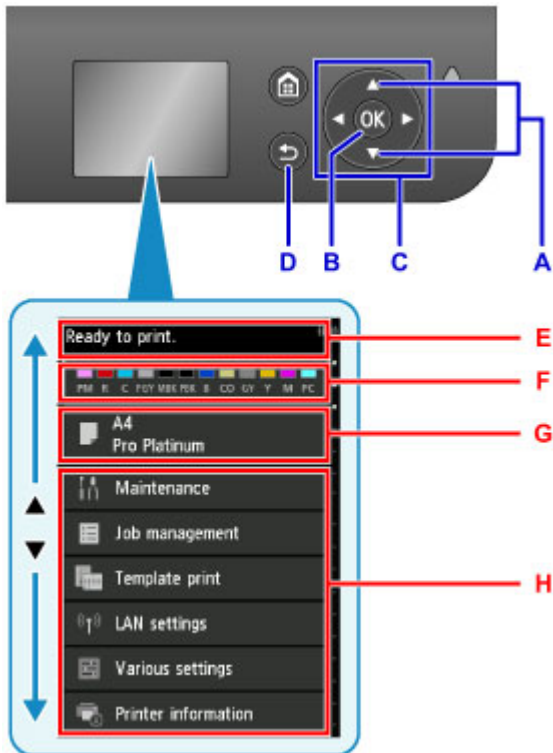

E: Printer status display area

Displays printer status, messages, and other information.

When a message appears, pressing the ▶ button displays the **Notice list** screen. Check the message or proceed to the details screen or the operation screen.

F: Ink status display area

Displays the ink status. Selecting this item enables you to check ink levels, view the ink tank replacement procedure, or check ink tank numbers.

G: Paper settings display area

Displays information about the paper in the rear tray. Selecting this item enables you to specify the size and type of paper loaded in the rear tray.

H: Other menu items

Shows maintenance job items or the various printer settings.

Selecting Menus

Menu item selection procedures depend on the item selected in the HOME screen.

Follow screen contents or directions to proceed with operation.

Example: Paper settings operation

Select the paper settings display area in the HOME screen by pressing the ▲ or ▼ button, then press the OK button.

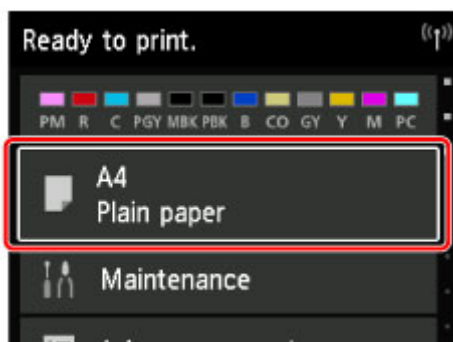

Select **Page size**, then press the OK button.

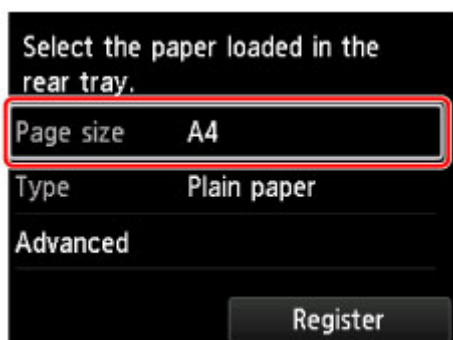

Select **A2** by pressing the ▲ or ▼ button, then press the OK button.

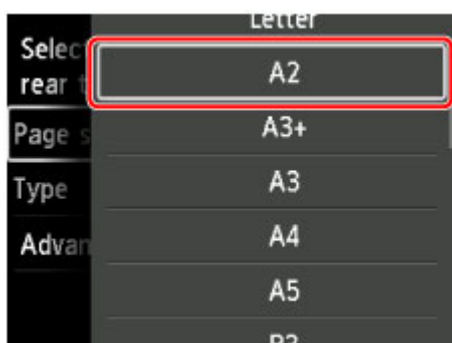

Select **Type** by pressing the ▼ button, then press the OK button.

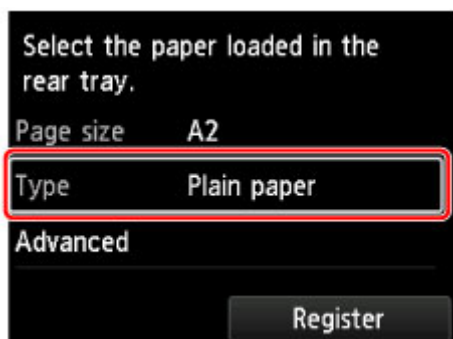

Select **Pro Platinum** by pressing the ▲ or ▼ button, then press the OK button.

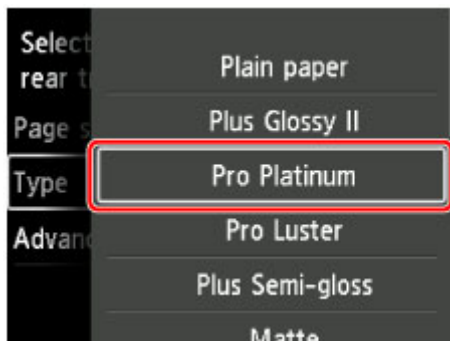

Select **Register** by pressing the ▼ button, then press the **OK** button.

This registers the paper settings.

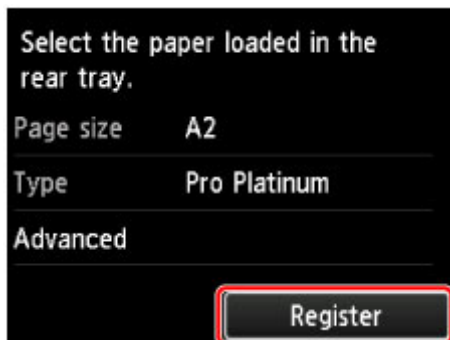

Changing Settings from Operation Panel/Web Browser

- ▶ **Changing Settings from Operation Panel**
- ▶ **Changing Printer's Setting Using Web Browser**

Changing Settings from Operation Panel

- **Changing Settings from Operation Panel**
- **Setting Items on Operation Panel**
- **Administrator password setting (Item for administrator)**
- **Device user settings (Item for administrator)**
- **Web service setup (Item for administrator)**
- **Language selection (Item for administrator)**
- **Energy saving settings (Item for administrator)**
- **Quiet setting (Item for administrator)**
- **Paper Settings**
- **Print settings**
- **PictBridge print settings**
- **Paper-related settings**
- **Job management**
- **Firmware update (Item for administrator)**
- **Printer information**
- **LAN settings (Item for administrator)**
- **Auto maintenance settings (Item for administrator)**
- **Maintenance page size**
- **Reset setting (Item for administrator)**

Changing Settings from Operation Panel

»» Important

- An administrator password is required to change some setting items.

This section describes the procedure to change the settings in the **Device settings** screen, taking the steps to specify **Prevent paper abrasion** as an example.

1. [Make sure printer is turned on.](#)

2. Select  **Various settings** on HOME screen.

■ [LCD and Operation Panel](#)

3. Use ▲▼ button to select **Device settings** and press **OK** button.

The **Device settings** screen appears.

4. Use ▲▼ button to select setting item and press **OK** button.

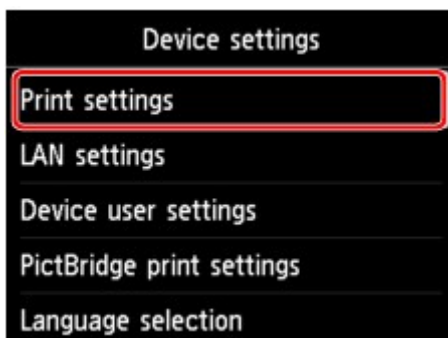

The setting screen for the selected item is displayed.

5. Use ▲▼ button to select item and press **OK** button.

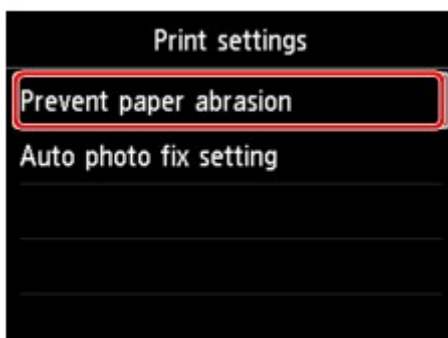

6. Use ▲▼ button to select setting item and press **OK** button.



For more on setting items on the operation panel:

■ [Setting Items on Operation Panel](#)

Setting Items on Operation Panel

Items for Security

■ [Administrator password setting \(Item for administrator\)](#)

Items for Printer

■ [Device user settings \(Item for administrator\)](#)

■ [Web service setup \(Item for administrator\)](#)

■ [Language selection \(Item for administrator\)](#)

■ [Energy saving settings \(Item for administrator\)](#)

■ [Quiet setting \(Item for administrator\)](#)

Items for Paper/Printing

■ [Paper-related settings](#)

■ [Print settings](#)

■ [PictBridge print settings](#)

Items for Maintenance/Management

■ [Job management](#)

■ [Firmware update \(Item for administrator\)](#)

■ [Printer information](#)

■ [LAN settings \(Item for administrator\)](#)

■ [Auto maintenance settings \(Item for administrator\)](#)

■ [Maintenance page size](#)

■ [Reset setting \(Item for administrator\)](#)

Administrator password setting (Item for administrator)

Select this setting item from **Device settings** on **Various settings**.

▶▶▶ Important

- This setting item is for the administrator. The administrator password is required to change settings.

You can specify or disable the administrator password.

If you specify the administrator password, select the range and specify the administrator password.

Remote UI or other tools

Entering the administrator password is required to change the setting items using the Remote UI or IJ Network Device Setup Utility.

LCD, Remote UI, or other tools

Entering the administrator password is required to change the setting items using the operation panel of the printer, the Remote UI, or IJ Network Device Setup Utility.

■ [Setting Administrator Password on Operation Panel](#)

Setting Administrator Password on Operation Panel

You can specify or disable the administrator password.

Specifying the administrator password requires you to enter the password to use the items or change the settings below.

- **Web service setup**
- **LAN settings**
- **Device user settings**
- **Language selection**
- **Firmware update**
- **Energy saving settings**
- **Quiet setting**
- **Auto maintenance settings**
- **Administrator password setting**
- **Reset setting** (except for **Reset all**)

Follow the procedure below to specify the administrator password.

1. [Make sure printer is turned on.](#)

2. Select  **Various settings** on HOME screen.

■ [LCD and Operation Panel](#)

3. Use ▲▼ button to select **Device settings** and press **OK** button.
4. Use ▲▼ button to select **Administrator password setting** and press **OK** button.
5. When confirmation screen to specify administrator password is displayed, select **Yes** and press **OK** button.

If an administrator password is not specified, the register confirmation message appears. Selecting **Yes** and pressing the **OK** button displays the message again.

▶▶▶ Important

- The administrator password is set at the time of purchase. The printer's serial number is used as the password.
For the administrator password, refer to Administrator Password.

6. Use ▲▼ button to select **Change administrator password** and press **OK** button.

If you do not specify an administrator password, select **Remove administrator password**. Selecting **Yes** and pressing the **OK** button displays the message again.

7. Use ▲▼ button to select range where administrator password is valid and press **OK** button.

Remote UI or other tools

Entering the administrator password is required to change the setting items using the Remote UI or IJ Network Device Setup Utility.

LCD, Remote UI, or other tools

Entering the administrator password is required to change the setting items using the operation panel of the printer, the Remote UI, or IJ Network Device Setup Utility.

8. Enter administrator password.

Pressing the **OK** button displays the input screen.

Use the **▲▼◀▶** button to select **OK** and press the **OK** button when you finished entering the password.

Important

- The following character restrictions apply to the password:
 - Set the password by using 4 to 32 characters.
 - The allowed characters are single-byte alphanumeric characters.
 - For security reasons, we recommend you use 6 and more alphanumeric characters.

9. Use **▲▼** button to select **Apply** and press **OK** button.

10. Enter administrator password you specified again.

Pressing the **OK** button displays the input screen.

Use the **▲▼◀▶** button to select **OK** and press the **OK** button when you finished entering the password.

The administrator password is enabled.

Device user settings (Item for administrator)

Select this setting item from **Device settings** on **Various settings**.

▶▶▶ Important

- This setting item is for the administrator. The administrator password is required to change settings.

- **Date/time setting**

Sets the current date and time.

▶▶▶ Important

- If a power failure occurs or you unplug the power cord, the date/time settings will be reset.

- **Date display format**

Changes the display format of dates when printed.

- **Key repeat**

Enables/Disables continuous input by pressing and holding down the ▲▼◀▶ button when selecting a menu or setting item.

- **Device info sending setting**

Selects whether you will send the printer usage information to Canon server. The information sent to Canon will be utilized to develop better products. Select **Agree** to send the printer usage information to Canon server.

- **Display job history**

Enables/Disables displaying the printing job history.

- **Use of Remote UI**

Enables/Disables Remote UI.

Web service setup (Item for administrator)

Select this setting item from **Various settings**.

▶▶▶ Important

- This setting item is for the administrator. The administrator password is required to change settings.

- **Web service connection setup**

The following setting items are available.

- **Google Cloud Print setup**

Registers/Deletes the printer to/from Google Cloud Print.

- **IJ Cloud Printing Center setup**

Registers/Deletes the printer to/from Canon Inkjet Cloud Printing Center.

- **Check Web service setup**

Make sure whether the printer is registered to Google Cloud Print or Canon Inkjet Cloud Printing Center.

- **DNS server setup**

Performs settings for a DNS server. Select **Auto setup** or **Manual setup**. If you select **Manual setup**, follow the display on the LCD to perform settings.

- **Proxy server setup**

Performs settings for a proxy server. Follow the display on the LCD to perform settings.

Language selection (Item for administrator)

Select this setting item from **Device settings** on **Various settings**.

Important

- This setting item is for the administrator. The administrator password is required to change settings.

Changes the language for messages and menus on the LCD.

Energy saving settings (Item for administrator)

Select this setting item from **Device settings** on **Various settings**.

Enabling this setting allows you to turn on/off the printer automatically to save electricity.

Important

- This setting menu is for the administrator. The administrator password is required to change settings.

- **Auto power off**

Specifies the length of time to turn off the printer automatically when no operation is made or no printing data is sent to the printer.

- **Auto power on**

Selecting **ON** enables the printer to turn on automatically when printing data is sent to the printer.

Quiet setting (Item for administrator)

Select this setting item from **Device settings** on **Various settings**.

Enable this function on the printer if you want to reduce the operating noise, such as when printing at night.

▶▶▶ Important

- This setting menu is for the administrator. The administrator password is required to change settings.

- **Do not use quiet mode**

Select when you do not use the quiet mode.

- **Use quiet mode**

Select to reduce the operating noise when printing.

▶▶▶ Important

- Operating speed is reduced compared to when **Do not use quiet mode** is selected.
- This function may not be so effective depending on the printer's setting. Furthermore, certain noise, such as when the printer is preparing for printing, is not reduced.

▶▶▶ Note

- You can set the quiet mode from the operation panel of the printer or the printer driver. No matter how you set the quiet mode, the mode is applied when you perform operations from the operation panel of the printer or printing from the computer.

Paper Settings

By registering the paper size and the media type loaded in the rear tray, you can prevent the printer from misprinting by displaying the message before printing starts when the paper size or the media type of the loaded paper differs from the print settings.

▶▶▶ Note

- The default display setting is different between when you print from the operation panel of the printer and when you print using the printer driver.

■ [Default Setting for Displaying the Message which Prevents Misprinting](#)

- **When you close the feed slot cover:**



The screen to register the rear tray paper information is displayed.

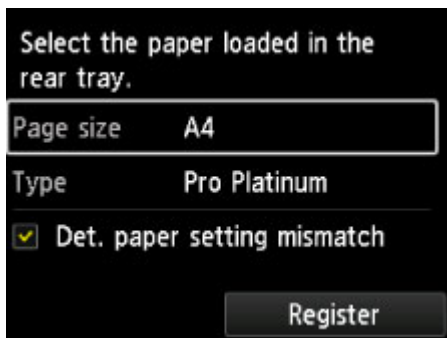

Register the paper size and the media type according to the loaded paper.

▶▶▶ Important

- For more on the proper combination of paper settings you can specify by the printer driver or on the LCD:
 - For Windows:
 - [Paper Settings on the Printer Driver and the Printer \(Media Type\)](#)
 - [Paper Settings on the Printer Driver and the Printer \(Paper Size\)](#)
 - For Mac OS:
 - [Paper Settings on the Printer Driver and the Printer \(Media Type\)](#)
 - [Paper Settings on the Printer Driver and the Printer \(Paper Size\)](#)

- When the paper settings for printing are different from the rear tray paper information registered to the printer:

Ex:

- Paper setting for printing: B5
- Rear tray paper information registered to the printer: A4

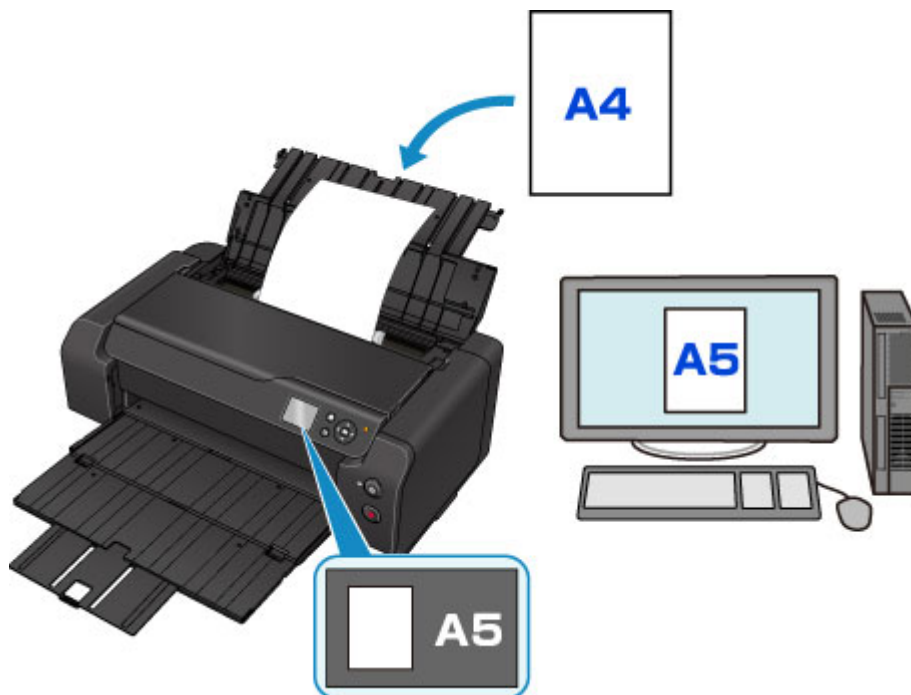

When you start printing, a message is displayed.

Pressing the **OK** button displays the paper setting specified for printing under the message.

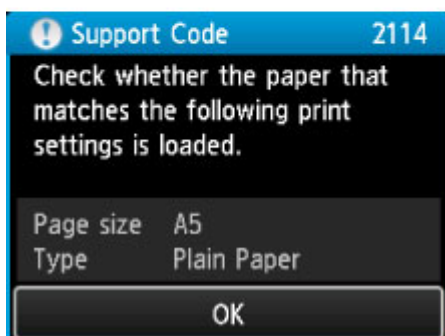
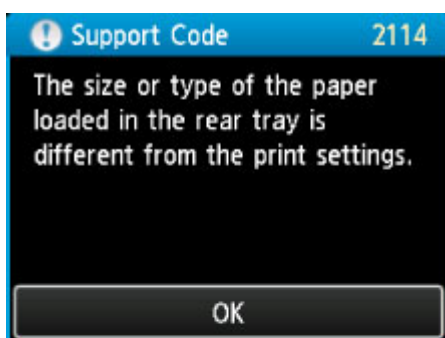

Check the message and press the **OK** button. When the screen to select the operation is displayed, select one of the operations below.

»»» Note

- Depending on the setting, the choices below may not be displayed.

Print with the loaded paper.

Select if you want to print on the paper loaded in the rear tray without changing the paper settings.

For example, when the paper setting for printing is A5 and the rear tray paper information registered to the printer is A4, the printer starts printing with A5 on the paper loaded in the rear tray.

Replace the paper and print

Select if you want to print after replacing the paper of the rear tray.

For example, when the paper setting for printing is A5 and the rear tray paper information registered to the printer is A4, you load A5 sized paper in the rear tray before you start printing.

The rear tray paper information registration screen is displayed after replacing the paper. Register the rear tray paper information according to the paper you loaded on the rear tray.

»»» Note

- If you do not know what paper information to register to the printer, press the **Back** button when the screen to select the operation is displayed. When the previous screen is displayed, check the paper size and the media type and register them to the printer.
- For more on the proper combination of paper settings you can specify by the printer driver or on the LCD:
 - For Windows:
 - [Paper Settings on the Printer Driver and the Printer \(Media Type\)](#)
 - [Paper Settings on the Printer Driver and the Printer \(Paper Size\)](#)
 - For Mac OS:
 - [Paper Settings on the Printer Driver and the Printer \(Media Type\)](#)
 - [Paper Settings on the Printer Driver and the Printer \(Paper Size\)](#)

Cancel

Cancels printing.

Select when you change the paper settings specified for printing. Change the paper settings and try printing again.

Default Setting for Displaying the Message which Prevents Misprinting

• When you print using the operation panel of the printer:

The message which prevents misprinting is enabled by default.

To change the display setting when you print using the operation panel of the printer:

■ [Paper-related settings](#)

• When you print using the printer driver:

The message which prevents misprinting is disabled by default.

To change the display setting when you print using the printer driver:

- For Windows:

■ [Changing the Printer Operation Mode](#)

- For Mac OS:

■ [Changing the Printer Operation Mode](#)

▶▶ Important

- When the message which prevents misprinting is disabled:

The printer starts printing even though the paper settings for printing and the rear tray paper information registered to the printer are different.

Print settings

Select this setting item from **Device settings** on **Various settings**.

- **Prevent paper abrasion**

Use this setting only if the print surface becomes smudged.

»»» Important

- Be sure to set this back to **OFF** after printing since it may result in lower printing speed or lower print quality.

- **Auto photo fix setting**

When **ON** is selected, you can select whether to print photos using the Exif information recorded in the image files when **Default*** or **On** is selected in printing with a PictBridge (Wireless LAN) compliant device.

* When **Default** is selected for the print setting on the PictBridge (Wireless LAN) compliant device, select **Auto photo fix** for **Photo fix** in **PictBridge print settings**.

PictBridge print settings

Select this setting item from **Device settings** on **Various settings**.

You can change the print settings when printing from a PictBridge (Wireless LAN) compliant device.

Set the print settings to **Default** on the PictBridge (Wireless LAN) compliant device when you want to print according to the settings on the printer.

To change print settings from the PictBridge (Wireless LAN) compliant device:

■ [Settings on PictBridge \(Wireless LAN\) Compliant Device](#)

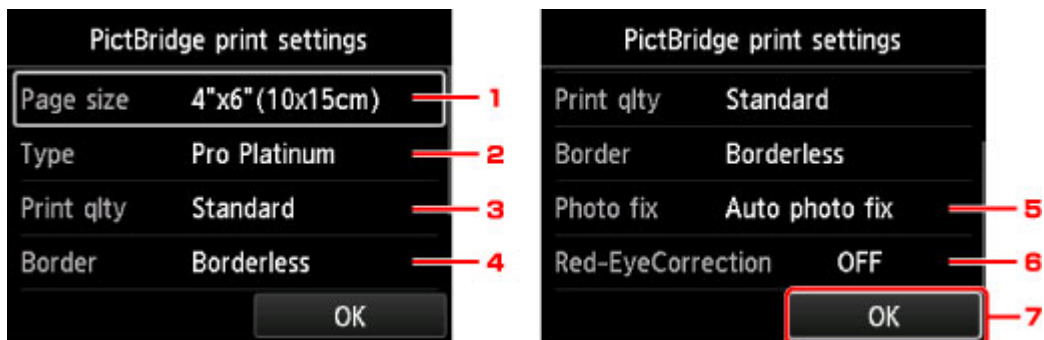

1. Page size

Select the paper size when printing directly from a PictBridge (Wireless LAN) compliant device.

When you perform PictBridge (Wireless LAN) settings from the printer, set **Paper size** to **Default** on the PictBridge (Wireless LAN) compliant device.

2. Type (Media type)

Select the media type when printing directly from a PictBridge (Wireless LAN) compliant device.

When you perform PictBridge (Wireless LAN) settings from the printer, set **Paper type** to **Default** on the PictBridge (Wireless LAN) compliant device.

3. Print qlty (Print quality)

Select the print quality when printing directly from a PictBridge (Wireless LAN) compliant device.

4. Border (Bordered/Borderless print)

Select the bordered/borderless layout.

When you perform PictBridge (Wireless LAN) settings from the printer, set **Layout** to **Default** on the PictBridge (Wireless LAN) compliant device.

5. Photo fix

When **Auto photo fix** is selected, the scene or person's face of a shot photo is recognized and the most suitable correction for each photo is made automatically. It makes a darkened face by backlight brighter to print. It also analyzes a scene such as scenery, night scene, person, etc. and corrects each scene with the most suitable color, brightness, or contrasts automatically to print.

▶▶▶ Note

- As a default, photos on a PictBridge (Wireless LAN) compliant device are printed with auto correction applied.

- If **No correction** is selected, photos are printed without correction.
-

6. **Red-EyeCorrection**

Select **ON** to correct red eyes in portraits caused by flash photography.

Depending on the type of the photo, red eyes may not be corrected or parts other than the eyes may be corrected.

7. Press **OK** button to specify the print settings.

Paper-related settings

Select this setting item from **Device settings** on **Various settings**.

- **Det. paper setting mismatch**

If you select **Yes**, the printer detects whether the paper size and the media type are the same as those registered. If printing starts with the settings that do not match, an error message appears on the LCD.

■ [Paper Settings](#)

- **Advanced paper settings**

Perform the following settings for each media type.

- **Paper Thickness (Head Height)**
- **Transport unit vacuum settings**
- **Extension for borderless printing**
- **Pause between scans**
- **Pause between pages**
- **Detect paper width**

Selecting **Reset paper settings by paper, Yes** and pressing the **OK** button initializes the settings.

Entering the administrator password is required if it is enabled.

- **Print advanced paper settings**

Selecting **Yes** and pressing the **OK** button prints out each setting specified in **Advanced paper settings**.

- **Reset paper settings for all paper**

Selecting **Yes** and pressing the **OK** button initializes each setting specified in **Advanced paper settings**.

Entering the administrator password is required if it is enabled.

Job management

Select this setting item from HOME screen.

- **Display job history**

Displays the job history (10 jobs from the latest). Selecting a print job and pressing the **OK** button displays the job details.

- **Print job history**

Selecting **Yes** and pressing the **OK** button prints out the printing job history.

Firmware update (Item for administrator)

Select this setting item from **Device settings** on **Various settings**.

▶▶▶ Important

- This setting item is for the administrator. The administrator password is required to change settings.

You can update the firmware of the printer, check the firmware version, or perform settings of a notification screen, a DNS server and a proxy server.

▶▶▶ Note

- Only **Check current version** is available when **Disable LAN** is selected for **Change LAN** in **LAN settings**.

- **Install update**

Performs the firmware update of the printer. If you select **Yes**, the firmware update starts. Follow the on-screen instructions to perform update.

▶▶▶ Important

- When you use this function, make sure the printer is connected to the Internet.

▶▶▶ Note

- If the firmware update is not complete, check the following and take an appropriate action.
 - When using wired LAN, make sure the printer is connected to the computer with a LAN cable properly.
 - Check the network settings such as a router.
 - If **Cannot connect to the server.** is displayed on the LCD, press the **OK** button and try again after a while.

- **Check current version**

You can check the current firmware version.

- **Update notification setting**

When **Yes** is selected and the firmware update is available, the screen to inform you of the firmware update is displayed on the LCD.

- **DNS server setup**

Performs settings for a DNS server. Select **Auto setup** or **Manual setup**. If you select **Manual setup**, follow the display on the LCD to perform settings.

- **Proxy server setup**

Performs settings for a proxy server. Follow the display on the LCD to perform settings.

Printer information

Select this setting item from HOME screen.

- **System information**

Displays printer's system information.

- **Error history**

Displays the error history.

Up to 5 error codes appears.

For more on the error code, refer to [List of Support Code for Error](#).

LAN settings (Item for administrator)

Select this setting item from **Device settings** on **Various settings**.

▶▶▶ Important

- This setting item is for the administrator. The administrator password is required to change settings.

- **Change LAN**

Enables either wireless LAN, wired LAN, or direct connection. You can also disable all.

- **Wireless LAN setup**

Selects the setup method for wireless LAN connection.

▶▶▶ Note

- You can also enter this setting menu by selecting **LAN settings** on the HOME screen. In this case, enable wireless LAN.

- **Cableless setup**

Select if you specify the settings of the access point information to the printer directly from a device (such as a smartphone) without operating the wireless router. Follow the on-screen instructions of the connecting device for the setup procedure.

- **Standard setup**

Select when you perform settings for wireless LAN manually using the operation panel of the printer.

- **WPS (Push button method)**

Select when you perform settings for wireless LAN using a wireless router supporting a Wi-Fi Protected Setup (WPS) push button method. Follow the on-screen instructions during setup.

- **Other setup**

- **Advanced setup**

Select when you perform settings for wireless LAN manually. You can specify multiple WEP keys.

- **WPS (PIN code method)**

Select when you perform settings for wireless LAN using a wireless router supporting a Wi-Fi Protected Setup (WPS) PIN code method. Follow the on-screen instructions during setup.

- **Confirm LAN settings**

The list of wired/wireless LAN or direct connection settings of this printer is displayed on the LCD. Selecting **Print LAN details** allows you to print the list.

- **LAN setting list**

The list of wired LAN settings of this printer is displayed on the LCD.

The following setting items are displayed. (Some setting items are not displayed depending on the printer settings.)

Items	Setting
Connection	Active/Inactive

IPv4 address	XXX. XXX. XXX. XXX (12 characters)
IPv4 subnet mask	XXX. XXX. XXX. XXX (12 characters)
IPv4 default gateway	XXX. XXX. XXX. XXX (12 characters)
IPv6 link-local address	XXXX: XXXX: XXXX: XXXX: XXXX: XXXX: XXXX: XXXX (32 characters)
IPv6 link-local prefix length	XXX (up to 3 digits)
IPv6 manual address	XXXX: XXXX: XXXX: XXXX: XXXX: XXXX: XXXX: XXXX (32 characters)
IPv6 manual prefix length	XXX (up to 3 digits)
IPv6 stateless address 1	XXXX: XXXX: XXXX: XXXX: XXXX: XXXX: XXXX: XXXX (32 characters)
IPv6 stateless prefix length 1	XXX (up to 3 digits)
IPv6 stateless address 2	XXXX: XXXX: XXXX: XXXX: XXXX: XXXX: XXXX: XXXX (32 characters)
IPv6 stateless prefix length 2	XXX (up to 3 digits)
IPv6 stateless address 3	XXXX: XXXX: XXXX: XXXX: XXXX: XXXX: XXXX: XXXX (32 characters)
IPv6 stateless prefix length 3	XXX (up to 3 digits)
IPv6 stateless address 4	XXXX: XXXX: XXXX: XXXX: XXXX: XXXX: XXXX: XXXX (32 characters)
IPv6 stateless prefix length 4	XXX (up to 3 digits)
IPv6 default gateway 1	XXXX: XXXX: XXXX: XXXX: XXXX: XXXX: XXXX: XXXX (32 characters)
IPv6 default gateway 2	XXXX: XXXX: XXXX: XXXX: XXXX: XXXX: XXXX: XXXX (32 characters)
IPv6 default gateway 3	XXXX: XXXX: XXXX: XXXX: XXXX: XXXX: XXXX: XXXX (32 characters)
IPv6 default gateway 4	XXXX: XXXX: XXXX: XXXX: XXXX: XXXX: XXXX: XXXX (32 characters)
MAC address	XX:XX:XX:XX:XX:XX (12 characters)
IPsec settings	Enable (ESP)/Enable (ESP & AH)/Enable (AH)/Disable
Pre-shared key	XXXXXXXXXXXXXXXXXXXX (16 characters)
Printer name	XXXXXXXXXXXXXXXXXXXX (up to 15 characters)
Bonjour service name	XXXXXXXXXXXXXXXXXXXX XXXXXXXXXXXXXXXXXXXX XXXXXXXXXXXXXXXXXXXX XXXXXXXXXXXXXXXXXXXX (up to 52 characters)

("XX" represents alphanumeric characters.)

◦ **WLAN setting list**

The list of wireless LAN settings of this printer is displayed on the LCD.

The following setting items are displayed. (Some setting items are not displayed depending on the printer settings.)

Items	Setting
Connection	Active/Inactive
SSID	XXXXXXXXXXXXXXXXXXXX XXXXXXXXXXXXXXXXXXXX (up to 32 characters)
Communication mode	Infrastructure
Channel	XX (up to 2 digits)
Wireless LAN security	Inactive/WEP(64bit)/WEP(128bit)/WPA-PSK(TKIP)/WPA-PSK(AES)/WPA2-PSK(TKIP)/WPA2-PSK(AES)
IPv4 address	XXX. XXX. XXX. XXX (12 characters)
IPv4 subnet mask	XXX. XXX. XXX. XXX (12 characters)
IPv4 default gateway	XXX. XXX. XXX. XXX (12 characters)
IPv6 link-local address	XXXX: XXXX: XXXX: XXXX: XXXX: XXXX: XXXX: XXXX (32 characters)
IPv6 link-local prefix length	XXX (up to 3 digits)
IPv6 manual address	XXXX: XXXX: XXXX: XXXX: XXXX: XXXX: XXXX: XXXX (32 characters)
IPv6 manual prefix length	XXX (up to 3 digits)
IPv6 stateless address 1	XXXX: XXXX: XXXX: XXXX: XXXX: XXXX: XXXX: XXXX (32 characters)
IPv6 stateless prefix length 1	XXX (up to 3 digits)
IPv6 stateless address 2	XXXX: XXXX: XXXX: XXXX: XXXX: XXXX: XXXX: XXXX (32 characters)
IPv6 stateless prefix length 2	XXX (up to 3 digits)
IPv6 stateless address 3	XXXX: XXXX: XXXX: XXXX: XXXX: XXXX: XXXX: XXXX (32 characters)
IPv6 stateless prefix length 3	XXX (up to 3 digits)
IPv6 stateless address 4	XXXX: XXXX: XXXX: XXXX: XXXX: XXXX: XXXX: XXXX (32 characters)
IPv6 stateless prefix length 4	XXX (up to 3 digits)
IPv6 default gateway 1	XXXX: XXXX: XXXX: XXXX: XXXX: XXXX: XXXX: XXXX (32 characters)

IPv6 default gateway 2	XXXX: XXXX: XXXX: XXXX: XXXX: XXXX: XXXX: XXXX (32 characters)
IPv6 default gateway 3	XXXX: XXXX: XXXX: XXXX: XXXX: XXXX: XXXX: XXXX (32 characters)
IPv6 default gateway 4	XXXX: XXXX: XXXX: XXXX: XXXX: XXXX: XXXX: XXXX (32 characters)
MAC address	XX:XX:XX:XX:XX:XX (12 characters)
IPsec settings	Enable (ESP)/Enable (ESP & AH)/Enable (AH)/Disable
Pre-shared key	XXXXXXXXXXXXXXXXXXXX (16 characters)
Printer name	XXXXXXXXXXXXXXXXXXXX (up to 15 characters)
Bonjour service name	XXXXXXXXXXXXXXXXXXXX XXXXXXXXXXXXXXXXXXXX XXXXXXXXXXXXXXXXXXXX XXXXXXXXXXXXXXXXXXXX (up to 52 characters)

("XX" represents alphanumeric characters.)

- **Direct connection setting list**

The list of direct connection settings of this printer is displayed on the LCD.

The following setting items are displayed. (Some setting items are not displayed depending on the printer settings.)

Items	Setting
Connection	Active/Inactive
SSID	DIRECT-XXXX-XXXXXXseries
Password	XXXXXXXXXXXX (10 characters)
Communication mode	Direct connection
Channel	3
Wireless LAN security	WPA2-PSK(AES)
IPv4 address	XXX. XXX. XXX. XXX (12 characters)
IPv4 subnet mask	XXX. XXX. XXX. XXX (12 characters)
IPv4 default gateway	XXX. XXX. XXX. XXX (12 characters)
IPv6 link-local address	XXXX: XXXX: XXXX: XXXX: XXXX: XXXX: XXXX: XXXX (32 characters)
IPv6 link-local prefix length	XXX (up to 3 digits)
MAC address	XX:XX:XX:XX:XX:XX (12 characters)
IPsec settings	Disable
Pre-shared key	XXXXXXXXXXXXXXXXXXXX (16 characters)

Printer name	XXXXXXXXXXXXXXXXXX (up to 15 characters)
Bonjour service name	XXXXXXXXXXXXXXXXXX XXXXXXXXXXXXXXXXXX XXXXXXXXXXXXXXXXXX XXXXXXXXXXXXXXXXXX (up to 52 characters)
Direct connection device name	XXXXXX-XXXXXXseries

("XX" represents alphanumeric characters.)

- **Print LAN details**

You can print out the network settings of the printer such as its IP address and SSID.

For more information on the printer's network setting is printed out:

■ [Printing Network Settings](#)

»»» Important

- The network settings printout contains important information about your network. Handle it with care.

- **Other settings**

»»» Important

- You cannot select the items below when **Disable LAN** is selected for **Change LAN**.

- **Set printer name**

Specifies the printer name. You can use up to 15 characters for the name.

»»» Note

- You cannot use the same printer name as that already used for other LAN connected devices.
- You cannot use a hyphen for the initial or last character of the printer name.

- **TCP/IP settings**

Performs IPv4 or IPv6 setting.

- **WSD setting**

Setting items when you use WSD (one of the network protocols supported in Windows 8.1, Windows 8, Windows 7, and Windows Vista).

- **Enable/disable WSD**

Selects whether WSD is enabled or disabled.

»»» Note

- When this setting is enabled, the printer icon is displayed on the Network Explorer in Windows 8.1, Windows 8, Windows 7, and Windows Vista.

- **Optimize inbound WSD**

Selecting **Active** allows you to receive the WSD printing data faster.

- **Timeout setting**

Specifies the timeout length.

- **Bonjour settings**

Setting items for LAN using Bonjour for Mac OS.

- **Enable/disable Bonjour**

- Selecting **Enable** allows you to use Bonjour to perform the network settings.

- **Service name**

- Specifies the Bonjour service name. You can use up to 48 characters for the name.

- ▶▶▶ **Note**

- You cannot use the same service name as that already used for other LAN connected devices.

- **LPR protocol setting**

Enables/disables the LPR setting.

- **RAW print**

Enables/disables RAW printing.

- **LLMNR**

Enables/disables LLMNR (Link-Local Multicast Name Resolution). Selecting **ON** allows the printer to detect printer's IP address from the printer name without a DNS server.

- **PictBridge communication**

Setting items for printing from a PictBridge (Wireless LAN) compliant device.

- **Enable/disable communication**

- Selecting **Enable** allows you to print from a PictBridge (Wireless LAN) compliant device.

- **Timeout setting**

- Specifies the timeout length.

- **Wireless LAN DRX setting**

Selecting **Enable** allows you to activate discontinuous reception when using wireless LAN.

- ▶▶▶ **Note**

- Depending on the wireless router you are using, discontinuous reception may not be activated even though **Enable** is selected.
 - Discontinuous reception is enabled only while the printer is on standby. (The LCD is in the screen saver mode.)

- **Wired LAN DRX setting**

Selecting **Enable** allows you to activate discontinuous reception when the printer is connected to a device compatible with wired LAN.

- **Direct connection settings**

Setting items are available when you connect a wireless communication device such as a smartphone or tablet to the printer.

- ▶▶▶ **Important**

- You can select these setting items only when **Activate direct connect.** is selected for **Change LAN.**

- **Update SSID/password**

Selecting **Yes** updates the identifier (SSID) and password for direct connection.

- **Direct connection device name**

Changes the printer's name displayed on a Wi-Fi Direct compatible device.

- **Connection request confirmation**

Selecting **Yes** displays the confirmation screen when a Wi-Fi Direct compatible device is connecting the printer.

- [Using Printer with Direct Connection](#)

Auto maintenance settings (Item for administrator)

Select this setting item from **Device settings** on **Various settings**.

▶▶▶ Important

- This setting item is for the administrator. The administrator password is required to change settings.

- **Auto nozzle check**

Enables/Disables automatic nozzle checking.

- **Nozzle check error display**

Enables/Disables displaying the nozzle check error.

- **System cleaning frequency**

Specifies the frequency of automatic system cleaning.

▶▶▶ Note

- To maintain print quality, we recommend you select **Short** if you use the printer at a higher place.

- **Ink maintenance (tank installed)**

Selecting **ON** allows the printer to shake ink tanks on a regular basis to maintain ink density.

▶▶▶ Important

- We recommend you select **ON**. Failure to perform the ink quality maintenance about once a week may affect print quality.

Maintenance page size

Select this setting item from **Device settings** on **Various settings**.

Specifies the paper size when you perform maintenance operation (e.g. print head alignment). Select A4 or Letter-size.

Reset setting (Item for administrator)

Select this setting item from **Device settings** on **Various settings**.

▶▶▶ Important

- This setting item is for the administrator. The administrator password is required to change settings.

You can set the settings back to the default.

- **Web service setup only**

Sets the Web service settings back to the default.

- **LAN settings only**

Sets the LAN settings other than the administrator password back to the default.

- **Settings only**

Sets the settings such as the paper size or media type back to the default.

- **Device info sending setting only**

Sets only the device information sending settings back to the default.

- **Reset all**

Sets all settings you made to the printer back to the default. The administrator password specified for the printer is set to the default setting.

▶▶▶ Note

- You cannot set the following setting items back to the default:
 - The language displayed on the LCD
 - The current position of the print head
 - CSR (Certificate Signing Request) for encryption method (SSL/TLS) setting
 - Media information registered to the printer by using Media Configuration Tool

Changing Printer's Setting Using Web Browser

- ▶ **Changing Setting Using Web Browser**
- ▶ **Changeable Setting Items Using Web Browser**
- ▶ **Setting Password**

Changing Settings Using Web Browser

You can check the printer status and change the printer settings using the web browser on your smartphone, tablet, or computer.

To check the printer status and to change the printer settings, display "Remote UI" on the web browser.

▶▶▶ Note

- You can use this function on the following OS and the web browser.
 - iOS device
 - OS: iOS 6.1 or later
 - Web browser: iOS standard Web browser (Mobile Safari)
 - Android device
 - OS: Android 2.3.3 or later
 - Web browser: Android standard Web browser (Browser or Chrome)
 - Mac OS device
 - OS: Mac OS X v.10.6 or later
 - Web browser: Safari 5.1 or later
 - Windows device
 - OS: Windows XP or later
 - Web browser: Internet Explorer 8 or later, Google Chrome 38.0.2125.104m or later, Mozilla Firefox 33.0 or later

1. Enable the use of Remote UI.

Enable the use of Remote UI by following the steps below.

1. [Make sure printer is turned on.](#)



2. Select **Various settings** on HOME screen.

 [LCD and Operation Panel](#)

3. Use ▲▼ button to select **Device settings** and press **OK** button.
4. Use ▲▼ button to select **Device user settings** and press **OK** button.
5. Use ▲▼ button to select **Use of Remote UI** and press **OK** button.
6. Use ▲▼ button to select **ON** and press **OK** button.

2. Check printer's IP address.

Check the printer's IP address by following the steps below.



1. Select **Various settings** on HOME screen.
2. Use ▲▼ button to select **Device settings** and press **OK** button.
3. Use ▲▼ button to select **LAN settings** and press **OK** button.
4. Use ▲▼ button to select **Confirm LAN settings** and press **OK** button.

5. Use ▲▼ button to select **LAN setting list** or **WLAN setting list** and press **OK** button.
 6. Use ◀▶ button to select **Yes** and press **OK** button.
 7. Check **IPv4 address**.
3. Open web browser on your smartphone, tablet, or computer and enter IP address.

Enter as following in the URL field of the web browser.

http://XXX.XX.X.XXX

Enter the IP address in "XXX.XX.X.XXX".

When you access, the printer information will be displayed on the web browser on your smartphone, tablet, or computer.

If you want to check the printer status and change the printer settings, proceed to the next step. If you do not, close the web browser.

4. Select **Log on** to check printer status and change printer settings.

The password authentication screen appears.

▶▶▶ Important

- Before the password authentication screen appears, a message to warn you that the identification information is not verified may be displayed.

You can set not to display a message by specifying the SSL/TLS settings of certificate for encrypted communication.

▶▶▶ Note

- When the standard user mode is enabled, choose either administrator mode or standard user mode to log on.
- After choosing a mode and selecting **Log on**, the password authentication screen of each mode appears.

5. Enter password.

■ Administrator Password

When the password authentication is complete, the menus that can be utilized are displayed on the web browser.

6. Check printer status and change printer settings.

For changeable setting items, see below.

■ [Changeable Setting Items Using Web Browser](#)

7. When you finish checking printer status and changing printer settings, select **Log off**.
8. Close web browser.

Changeable Setting Items Using Web Browser

▶▶▶ Note

- The items described here and the items displayed in the web browser may differ in display order.
- The item which can be used is different in administrator mode or in standard user mode.

Items for Security

Security (Item for administrator)

This function allows you to specify the password, the standard user mode settings, and SSL/TLS settings of certificate for encrypted communication.

For the password, see Administrator Password.

For details on setting password, see [Setting Password](#).

Items for Maintenance/Management

Utilities

This function allows you to set and execute the printer utility functions such as cleaning.

Job management

This function allows you to display the job history and print it.

▶▶▶ Note

- When you are logging on in administrator mode, you can restrict this function in standard user mode.

System info and LAN settings

This function allows you to check the system information and to change the LAN settings.

▶▶▶ Note

- Some of the menu is available only when you logged on in administrator mode.

Firmware update (Item for administrator)

This function allows you to update the firmware and check version information.

Language selection (Item for administrator)

This function allows you to change the language on the display.

Items for Printer

Device settings

This function allows you to change the printer settings such as the quiet setting, the energy saving settings, and the print settings.

▶▶▶ Note

- Some of the menu is available only when you logged on in administrator mode.

AirPrint settings

This function allows you to specify the AirPrint settings, such as position information.

Web service connection setup (Item for administrator)

This function allows you to register to Google Cloud Print or IJ Cloud Printing Center, or delete a registration.

Other Items

Printer status

This function displays printer information such as the remaining ink amount, the status, and detailed error information.

You can also connect to the ink purchase site or support page, and use Web Services.

Manual (Online)

This function displays the *Online Manual*.

Setting Password

Each of passwords for administrator and standard user can be set.

When logging on with password for administrator, all settings can be changed.

When logging on with password for standard user, some of the settings can be changed.

When logging on with password for administrator, you can restrict the function for standard user.

■ [Setting Administrator Password](#)

■ [Setting Standard User Password](#)

▶▶▶ Note

- Password can be set only when you are logged in administrator mode.

Setting Administrator Password

Change the administrator password by following the steps below.

▶▶▶ Important

- The password is set at the time of purchase. The password is the printer's serial number.
For the password, see Administrator Password.

1. [Display printer status on web browser.](#)

2. Select **Security**.

The menus are displayed.

3. Select **Administrator password setting**.

4. Select **Change administrator password**.

If the administrator password is not set, registration confirming message is displayed. Select **Yes**.
When message is displayed again, select **OK**.

5. Select a range where the administrator password is valid, and then select **OK**.

Remote UI or other tools

Entering the administrator password is required to change the setting items using the Remote UI or IJ Network Device Setup Utility.

LCD, Remote UI, or other tools

Entering the administrator password is required to change the setting items using the operation panel of the printer, the Remote UI, or IJ Network Device Setup Utility.

6. Enter a password, and then select **OK**.

▶▶▶ Important

- The following character restrictions apply to the password:
 - Set the password by using 4 to 32 characters.
 - The allowed characters are single-byte alphanumeric characters.

- For security reasons, we recommend you use 6 and more alphanumeric characters.

7. When the completion message is displayed, select **OK**.

Setting Standard User Password

Enable the standard user mode and set a standard user password by following the steps below.

1. [Display printer status on web browser.](#)

2. Select **Security**.

The menus are displayed.

3. Select **Standard user mode settings**.

4. When the confirming message is displayed, select **Yes**.

5. Enter a password, and then select **OK**.

Important

- The following character restrictions apply to the password:
 - Set the password by using 4 to 32 characters.
 - The allowed characters are single-byte alphanumeric characters.
 - For security reasons, we recommend you use 6 and more alphanumeric characters.

6. When the completion message is displayed, select **OK**.

Printer Parts

- ▶ **Front View**
- ▶ **Rear View**
- ▶ **Power Supply**
 - Confirming that the Power Is On
 - Turning the Printer On and Off
 - Notice for the Power Plug/Power Cord
 - Notice for Unplugging the Power Cord

Front View

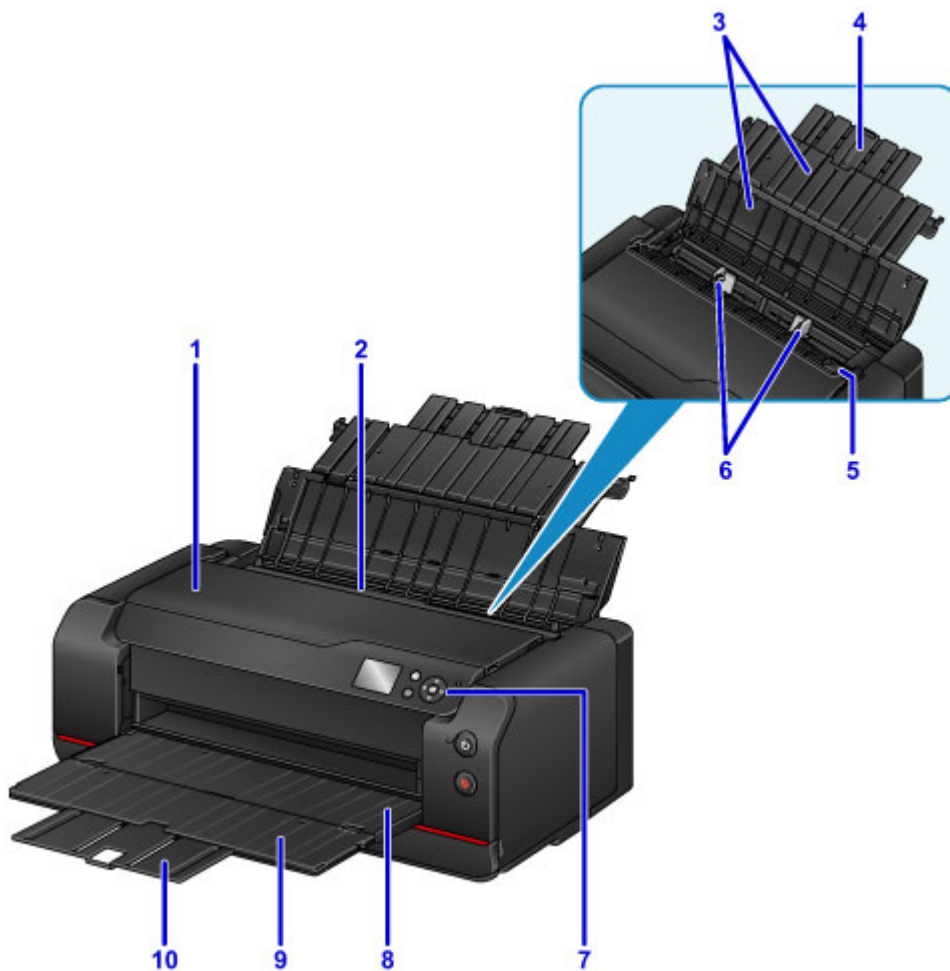

(1) top cover

Open when removing jammed paper inside the printer.

(2) rear tray

Two or more sheets of the same size and type of paper can be loaded at the same time, and fed automatically one sheet at a time.

■ [Loading Paper in the Rear Tray](#)

(3) paper support

Open to load paper in the rear tray.

(4) paper support extension

Extend to load paper in the rear tray.

(5) feed slot cover

Prevents anything from falling into the feed slot.

Open it to slide the paper guides, and close it before printing.

(6) paper guides

Align with both sides of the paper stack.

(7) operation panel

Use to change the printer settings or to operate it.

■ [Operation Panel](#)

(8) paper output tray

Printed paper is ejected. Open it before printing.

(9) output tray extension

Open to support ejected paper.

(10) paper output support

Pull out to support ejected paper.

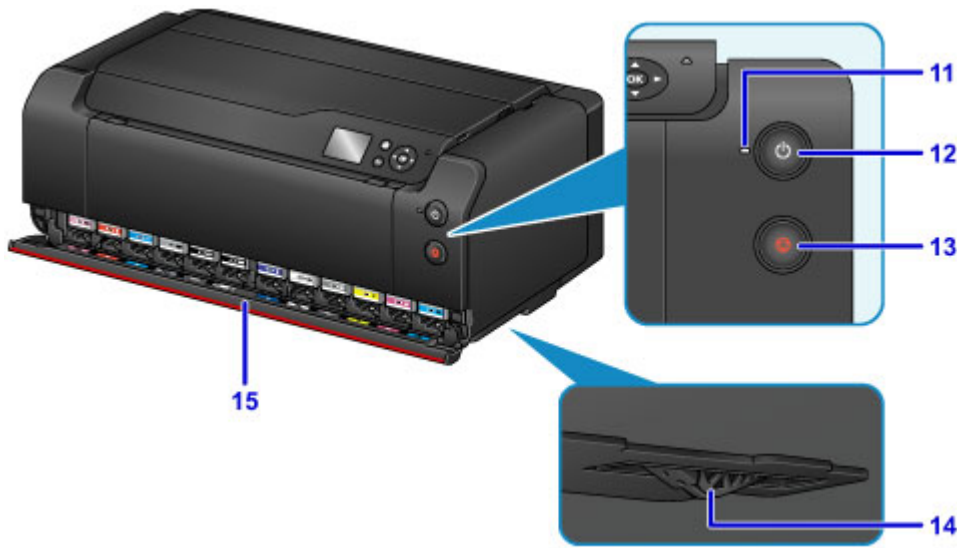

(11) POWER lamp

Lights after flashing when the power is turned on.

(12) ON button

Turns the power on or off.

■ [Turning the Printer On and Off](#)

(13) Stop button

Cancels a print job in progress.

(14) ink supply stopper

If the ink supply stopper at the bottom of the printer sticks out, an error message appears and the printer stops operation. Paying attention to the ink supply stopper, install the printer on a flat surface.

(15) tank cover

Open when replacing ink tanks.

▶▶▶ Note

- For details on how to replace ink tanks, see [Replacing Ink](#).

Rear View

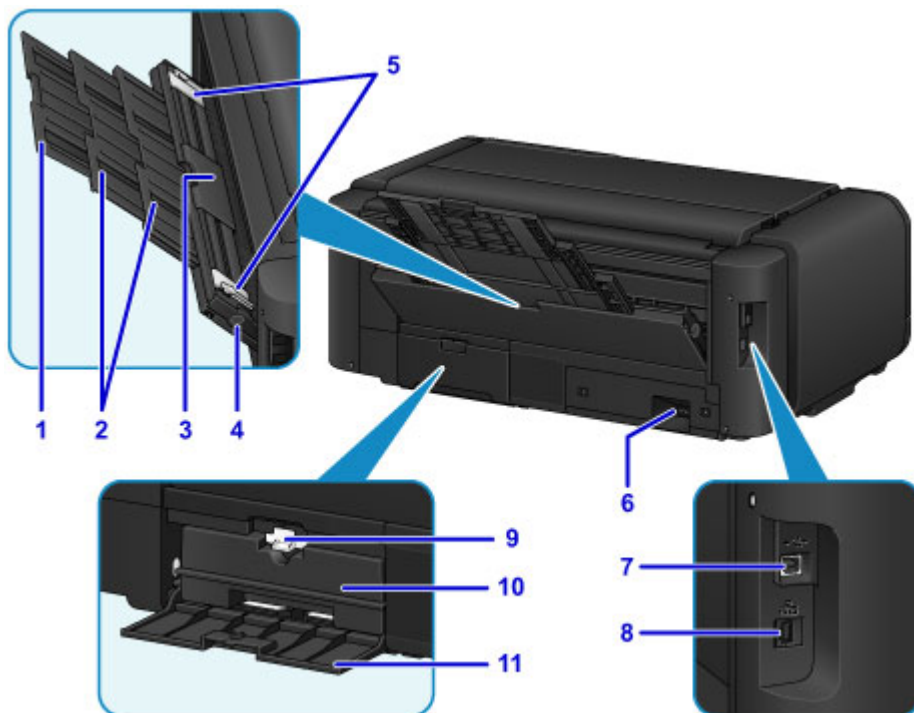

(1) paper support extension

Extend to load paper in the manual feed tray.

(2) paper support

Pull out to load paper in the manual feed tray.

(3) manual feed tray

Load one sheet of 8" x 10" (20 x 25 cm), A4, Letter size paper or larger, or thick paper at a time.

■ [Loading Paper in the Manual Feed Tray](#)

■ [Media Types You Can Use](#)

(4) Paper Jam Clearing button

Press this button when removing paper jammed in the manual feed tray.

■ [Paper Jams](#)

(5) paper guides

Align with both sides of the paper stack.

(6) power cord connector

Plug in the supplied power cord.

(7) USB port

Plug in the USB cable to connect the printer with a computer.

▶▶▶ Important

- Do not touch the metal casing.
- Do not plug in or unplug the USB cable or LAN cable while printing.

(8) wired LAN connector

Plug in the LAN cable to connect the printer to a LAN.

(9) lock lever

Locks the maintenance cartridge into place so that it does not come off. Keep the maintenance cartridge locked for normal use.

(10) maintenance cartridge

Absorbs ink used for cleaning and other operations.

▶▶ Note

- For details on how to replace the maintenance cartridge, see [Replacing the Maintenance Cartridge](#).

(11) maintenance cover

Open when replacing the maintenance cartridge.

Power Supply

- ▶ **Confirming that the Power Is On**
- ▶ **Turning the Printer On and Off**
- ▶ **Notice for the Power Plug/Power Cord**
- ▶ **Notice for Unplugging the Power Cord**

Confirming that the Power Is On

The **POWER** lamp is lit when the printer is turned on.

Even if the LCD is off, if the **POWER** lamp is lit, the printer is on.



▶▶ Note

- It may take about 30 seconds to 4 minutes for the printer to start printing immediately after you turn on the printer.
- The LCD will turn off if the printer is not operated for about 5 minutes. To restore the display, press any button except the **ON** button on the operation panel or perform the print operation. You cannot change the wait time before the LCD turns off.

Turning the Printer On and Off

Turning on the printer

1. Press the **ON** button to turn on the printer.

The **POWER** lamp flashes and then remains lit.

■ [Confirming that the Power Is On](#)

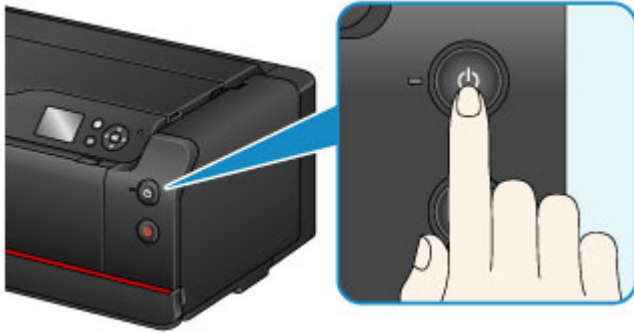

▶▶ Note

- It may take about 30 seconds to 4 minutes for the printer to start printing immediately after you turn on the printer.
- If the **Alarm** lamp lights up or flashes and an error message is displayed on the LCD, see [Message Appears](#).
- You can set the printer to automatically turn on when a print is performed from a computer connected by USB cable or network. This feature is set to off by default.

From the printer

- [Energy saving settings \(Item for administrator\)](#)

From the computer

- [Managing the Printer Power \(Windows\)](#)
- [Managing the Printer Power \(Mac OS\)](#)

Turning off the printer

1. Press the **ON** button to turn off the printer.

When the **POWER** lamp stops flashing, the printer is turned off.

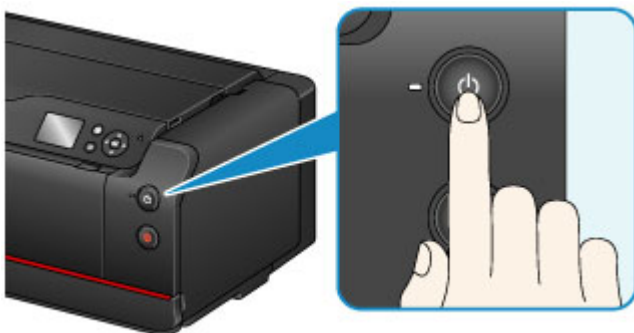

»» Important

- When you [unplug the power cord](#) after turning off the printer, be sure to confirm that the **POWER** lamp is off.

»» Note

- You can set the printer to automatically turn off when no operations are performed or no print jobs are sent to the printer for a certain interval. This feature is set to on by default.

From the printer

- [Energy saving settings \(Item for administrator\)](#)

From the computer

- [Managing the Printer Power \(Windows\)](#)
- [Managing the Printer Power \(Mac OS\)](#)

Notice for the Power Plug/Power Cord

Unplug the power cord once a month to confirm that the power plug/power cord does not have anything unusual described below.

- The power plug/power cord is hot.
- The power plug/power cord is rusty.
- The power plug/power cord is bent.
- The power plug/power cord is worn.
- The power plug/power cord is split.

Caution

- If you find anything unusual with the power plug/power cord described above, [unplug the power cord](#) and call for service. Using the printer with one of the unusual conditions above may cause a fire or an electric shock.

Notice for Unplugging the Power Cord

To unplug the power cord, follow the procedure below.

▶▶ Important

- When you unplug the power cord, press the **ON** button, then confirm that the **POWER** lamp is off. Unplugging the power cord while the **POWER** lamp is lit or flashing may cause drying or clogging of the print head and print quality may be reduced.

1. Press the **ON** button to turn the printer off.

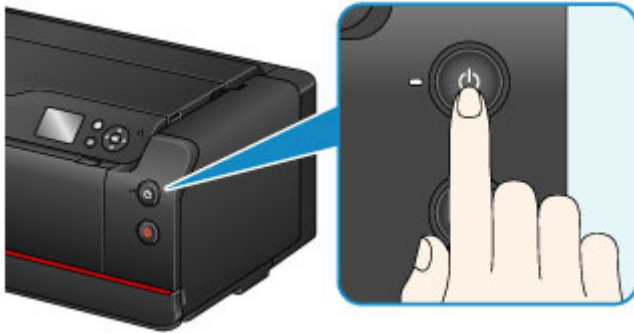

2. Confirm that the **POWER** lamp is off.



3. Unplug the power cord.

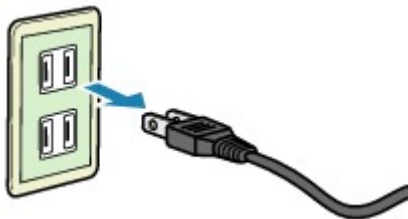

The specification of the power cord differs depending on the country or region of use.

Network Setting

▶ Network Connection

- Network Connection Tips

▶ Network Settings (IJ Network Device Setup Utility) (Windows)

- IJ Network Device Setup Utility
- Starting Up IJ Network Device Setup Utility
- IJ Network Device Setup Utility Screen
- Performing Network Settings
- Checking Network Status
- IJ Network Device Setup Utility Menus
- Other Network Information

Network Connection

- ▶ [Network Connection Tips](#)

Network Connection Tips

- ▶ **Default Network Settings**
- ▶ **Another Printer Found with Same Name**
- ▶ **Printing Network Settings**
- ▶ **Changing LAN Connection Method/Changing Wireless LAN Connection Method (Windows)**

Default Network Settings

LAN Connection Defaults

Item	Default
Change LAN	Disable LAN
SSID	BJNPSETUP
Communication mode	Infrastructure
Wireless LAN security	Disable
IP address (IPv4)	Auto setup
IP address (IPv6)	Auto setup
Set printer name*	XXXXXXXXXXXX
Enable/disable IPv6	Enable
Enable/disable WSD	Enable
Timeout setting	1 minute
Enable/disable Bonjour	Enable
Service name	Canon PRO-1000 series
LPR protocol setting	Enable
PictBridge communication	Enable
Wireless LAN DRX setting	Enable
Wired LAN DRX setting	Enable

("XX" represents alphanumeric characters.)

* Default value depends on printer. To check value, use operation panel.

 [LAN settings \(Item for administrator\)](#)

Direct Connection Defaults

Item	Default
SSID (Identifier for direct connection)	DIRECT-abXX-PRO-1000series *1
Password	YYYYYYYYYY *2
Wireless LAN security	WPA2-PSK (AES)
Direct connection device name	ZZZZZ-PRO-1000series *3
Connection request confirmation	Displayed

*1 "ab" is specified at random and "XX" represents last two digits of printer's MAC address. (The value is specified when the printer is turned on for the first time.)

*2 The password is specified automatically when the printer is turned on for the first time.

*3 "ZZZZZZ" represents last six digits of printer's MAC address.

Another Printer Found with Same Name

When the printer is found during setup, other printers with the same name may appear on the results screen.

Select a printer with checking the printer settings against those on detection result screen.

Check the printer's MAC address or serial to select the correct printer from the results.

Note

- Serial number may not appear on result screen.

To check the printer's MAC address and the serial number, print out the network settings information using the operation panel.

[Printing Network Settings](#)

Regarding the MAC address, you can check the network setting information on the LCD. Select **WLAN setting list** or **LAN setting list** from **Confirm LAN settings** on **LAN settings** on **Device settings** under **Various settings**, and check the address shown on the LCD.

Printing Network Settings

Use the operation panel to print the printer's current network settings.

»» Important

- The network settings printout contains important information about your network. Handle it with care.

1. [Make sure printer is turned on.](#)
2. [Load three sheets of A4 or Letter-sized plain paper.](#)
3. Select  **Various settings** on HOME screen.
[LCD and Operation Panel](#)
4. Use ▲▼ button to select **Device settings** and press **OK** button.
5. Use ▲▼ button to select **LAN settings** and press **OK** button.
6. Use ▲▼ button to select **Confirm LAN settings** and press **OK** button.
7. Use ▲▼ button to select **Print LAN details** and press **OK** button.
8. Use ◀▶ button to select **Yes** and press **OK** button to start printing.

The printer starts printing network settings information.

The printed network settings information is as follows:

Item	Description	Setting
Product Information	Product information	—
Product Name	Product name	XXXXXXXX
ROM Version	ROM version	XXXXXXXX
Serial Number	Serial number	XXXXXXXX
Wireless LAN	Wireless LAN	Enable/Disable
MAC Address	MAC address	XX:XX:XX:XX:XX:XX
Infrastructure	Infrastructure	Enable/Disable
Connection	Connection status	Active/Inactive
SSID	SSID	Wireless LAN SSID
Channel *1	Channel	XX (1 to 11)
Encryption	Encryption method	None/WEP/TKIP/AES
WEP Key Length	WEP key length (bits)	Inactive/128/64

Authentication	Authentication method	None/auto/open/shared/WPA-PSK/WPA2-PSK
Signal Strength	Signal strength	0 to 100 [%]
TCP/IPv4	TCP/IPv4	Enable
IP Address	IP address	XXX.XXX.XXX.XXX
Subnet Mask	Subnet mask	XXX.XXX.XXX.XXX
Default Gateway	Default gateway	XXX.XXX.XXX.XXX
TCP/IPv6	TCP/IPv6	Enable/Disable
Link Local Address	Link local address	XXXX:XXXX:XXXX:XXXX XXXX:XXXX:XXXX:XXXX
Link Local Prefix Length	Link local prefix length	XXX
Manual Setting	Manual setting	Enable/Disable
IP Address *2	IP address	XXXX:XXXX:XXXX:XXXX XXXX:XXXX:XXXX:XXXX
Subnet Prefix Length *2	Subnet prefix length	XXX
Stateless Address1 *2	Stateless address 1	XXXX:XXXX:XXXX:XXXX XXXX:XXXX:XXXX:XXXX
Stateless Prefix Length1 *2	Stateless prefix length1	XXX
Stateless Address2 *2	Stateless address 2	XXXX:XXXX:XXXX:XXXX XXXX:XXXX:XXXX:XXXX
Stateless Prefix Length2 *2	Stateless prefix length 2	XXX
Stateless Address3 *2	Stateless address 3	XXXX:XXXX:XXXX:XXXX XXXX:XXXX:XXXX:XXXX
Stateless Prefix Length3 *2	Stateless prefix length 3	XXX
Stateless Address4 *2	Stateless address 4	XXXX:XXXX:XXXX:XXXX XXXX:XXXX:XXXX:XXXX
Stateless Prefix Length4 *2	Stateless prefix length 4	XXX
Default Gateway1 *2	Default gateway 1	XXXX:XXXX:XXXX:XXXX XXXX:XXXX:XXXX:XXXX
Default Gateway2 *2	Default gateway 2	XXXX:XXXX:XXXX:XXXX XXXX:XXXX:XXXX:XXXX
Default Gateway3 *2	Default gateway 3	XXXX:XXXX:XXXX:XXXX XXXX:XXXX:XXXX:XXXX
Default Gateway4 *2	Default gateway 4	XXXX:XXXX:XXXX:XXXX XXXX:XXXX:XXXX:XXXX

IPsec *3	IPsec setting	Active
Security Protocol *3	Security method	ESP/ESP & AH/AH
Wireless LAN DRX	Discontinuous reception (wireless LAN)	Enable/Disable
Direct Connection	Direct connection	Enable/Disable
Connection	Connection status	Active/Inactive
SSID	SSID	Direct Connection SSID
Password	Password	Direct Connection password (10 alphanumeric characters)
Channel	Channel	3
Encryption	Encryption method	AES
Authentication	Authentication method	WPA2-PSK
TCP/IPv4	TCP/IPv4	Enable
IP Address	IP address	XXX.XXX.XXX.XXX
Subnet Mask	Subnet mask	XXX.XXX.XXX.XXX
Default Gateway	Default gateway	XXX.XXX.XXX.XXX
TCP/IPv6	TCP/IPv6	Enable/Disable
Link Local Address	Link local address	XXXX:XXXX:XXXX:XXXX XXXX:XXXX:XXXX:XXXX
Link Local Prefix Length	Link local prefix length	XXX
IPsec *3	IPsec setting	Active
Security Protocol *3	Security method	–
Wireless LAN DRX	Discontinuous reception (wireless LAN)	Enable/Disable
Wired LAN	Wired LAN	Enable/Disable
MAC Address	MAC address	XX:XX:XX:XX:XX:XX/Disable
Connection	Wired LAN status	Active/Inactive
TCP/IPv4	TCP/IPv4	Enable
IP Address	IP address	XXX.XXX.XXX.XXX
Subnet Mask	Subnet mask	XXX.XXX.XXX.XXX
Default Gateway	Default gateway	XXX.XXX.XXX.XXX
TCP/IPv6	TCP/IPv6	Enable/Disable

Link Local Address	Link local address	XXXX:XXXX:XXXX:XXXX XXXX:XXXX:XXXX:XXXX
Link Local Prefix Length	Link local prefix length	XXX
Manual Setting	Manual setting	Enable/Disable
IP Address *2	IP address	XXXX:XXXX:XXXX:XXXX XXXX:XXXX:XXXX:XXXX
Subnet Prefix Length *2	Subnet prefix length	XXX
Stateless Address1 *2	Stateless address 1	XXXX:XXXX:XXXX:XXXX XXXX:XXXX:XXXX:XXXX
Stateless Prefix Length1 *2	Stateless prefix length 1	XXX
Stateless Address2 *2	Stateless address 2	XXXX:XXXX:XXXX:XXXX XXXX:XXXX:XXXX:XXXX
Stateless Prefix Length2 *2	Stateless prefix length 2	XXX
Stateless Address3 *2	Stateless address 3	XXXX:XXXX:XXXX:XXXX XXXX:XXXX:XXXX:XXXX
Stateless Prefix Length3 *2	Stateless prefix length 3	XXX
Stateless Address4 *2	Stateless address 4	XXXX:XXXX:XXXX:XXXX XXXX:XXXX:XXXX:XXXX
Stateless Prefix Length4 *2	Stateless prefix length 4	XXX
Default Gateway1 *2	Default gateway 1	XXXX:XXXX:XXXX:XXXX XXXX:XXXX:XXXX:XXXX
Default Gateway2 *2	Default gateway 2	XXXX:XXXX:XXXX:XXXX XXXX:XXXX:XXXX:XXXX
Default Gateway3 *2	Default gateway 3	XXXX:XXXX:XXXX:XXXX XXXX:XXXX:XXXX:XXXX
Default Gateway4 *2	Default gateway 4	XXXX:XXXX:XXXX:XXXX XXXX:XXXX:XXXX:XXXX
IPsec *3	IPsec setting	Active
Security Protocol *3	Security method	ESP/ESP & AH/AH
Wired LAN DRX	Discontinuous reception (wired LAN)	Enable/Disable
Other Settings	Other settings	–
Printer Name	Printer name	Printer name (Up to 15 alphanumeric characters)
Direct Conn. DevName	Device name for direct connection	Device name for direct connection (Up to 32 characters)
WSD Printing	WSD printing setting	Enable/Disable

WSD Timeout	Timeout	1/5/10/15/20 [min]
LPD Printing	LPD printing setting	Enable/Disable
RAW Printing	RAW printing setting	Enable/Disable
Bonjour	Bonjour setting	Enable/Disable
Bonjour Service Name	Bonjour service name	Bonjour service name (Up to 52 alphanumeric characters)
LLMNR	LLMNR setting	Enable/Disable
SNMP	SNMP setting	Enable/Disable
PictBridge Commun.	PictBridge communication	Enable/Disable
DNS Server	Obtain DNS server address automatically	Auto/Manual
Primary Server	Primary server address	XXX.XXX.XXX.XXX
Secondary Server	Secondary server address	XXX.XXX.XXX.XXX
Proxy Server	Proxy server setting	Enable/Disable
Proxy Address	Proxy address	XXXXXXXXXXXXXXXXXXXXXXX
Proxy Port	Proxy port specification	1 to 65535

("XX" represents alphanumeric characters.)

*1 Channel may range from 1 to 11 depending on country or region of purchase.

*2 Network status is only printed when IPv6 is enabled.

*3 Network status is only printed when IPv6 and IPsec settings are enabled.

Changing LAN Connection Method/Changing Wireless LAN Connection Method (Windows)

■ [Changing LAN Connection Method](#)

■ [Changing Wireless LAN Connection Method](#)

Changing LAN Connection Method

Follow either procedure below to change LAN connection method (wired or wireless).

- Use the Setup CD-ROM or follow the instructions on the Canon website to redo setup.
- Select **LAN settings** on HOME screen, select **Change LAN**, and then select **Activate wireless LAN** or **Activate wired LAN**. After that, perform settings on the **Protocol Settings...** screen on IJ Network Device Setup Utility.

Refer to Performing/Changing Wireless LAN Settings to change the connection method from wired LAN to wireless LAN.

Refer to Performing/Changing Wired LAN Settings to change the connection method from wireless LAN to wired LAN.

Changing Wireless LAN Connection Method

Follow either procedure below to change wireless LAN connection method (infrastructure or direct connection).

- Use the Setup CD-ROM or follow the instructions on the Canon website to redo setup.
- Perform settings on the **Protocol Settings...** screen on IJ Network Device Setup Utility.

▶▶ Important

- Before you perform settings using IJ Network Device Setup Utility, turn on cableless setup mode on the printer following the procedure below.

1. [Make sure printer is turned on.](#)

2. Select  **LAN settings** on HOME screen.

■ [LCD and Operation Panel](#)

3. Use ▲▼ button to select **Wireless LAN setup** and press **OK** button.
4. Select **Cableless setup** and press **OK** button.
5. Check message and press **OK** button.

Follow instructions on your smartphone or tablet.

6. If message saying setup is completed appears, press **OK** button.

Adjustments for Better Print Quality

- ▶ **Aligning the Print Head**
- ▶ **Aligning the Print Head Manually**

Aligning the Print Head

If printed ruled lines are misaligned or print results are otherwise unsatisfactory, adjust the print head position.

▶▶▶ Note

- We recommend using the same type of paper for print head alignment as for printing.
- Plain paper cannot be used for print head alignment.
- If the remaining ink level is low, the print head alignment sheet will not be printed correctly.

[Replace the ink tank](#) whose ink is low.

You need to prepare: three sheets of A4 or Letter size paper

1. Make sure that the power is turned on.
2. Select **Maintenance** on the HOME screen, then press the **OK** button.

■ [LCD and Operation Panel](#)

The **Maintenance** screen will appear.

3. Select **Print head alignment**, then press the **OK** button.

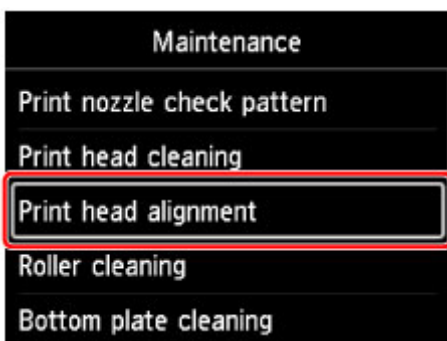

The **Print head alignment** screen will appear.

4. Select **Auto**, then press the **OK** button.

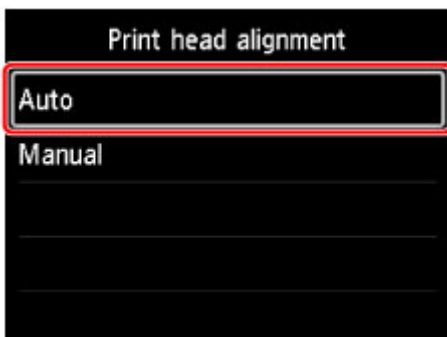

The confirmation screen will appear.

5. Select **Yes**, then press the **OK** button.

The paper settings screen will appear.

Specify **Page size** and **Type** for the paper to be used, select **Settings**, then press the **OK** button.

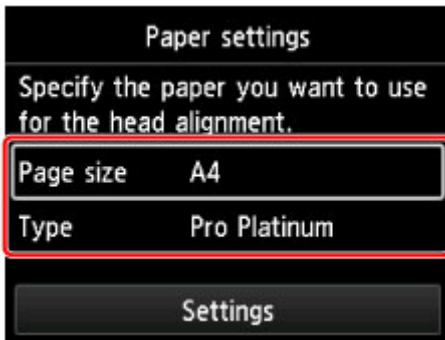

6. Load the prepared paper in the paper source specified in the message.

If the paper source is the manual feed tray, load one sheet of paper at a time.

7. Open the paper output tray gently.

Open the output tray extension, then pull out the paper output support.

8. Press the **OK** button.

The print head alignment sheet will be printed and the print head position will be adjusted automatically.

This takes about 12 minutes.

▶▶▶ Note

- If the automatic adjustment of the print head position has failed, an error message appears on the LCD.

■ [Message Appears](#)

9. When the completion message appears, press the **OK** button.

▶▶▶ Note

- If the print results are still not satisfactory after adjusting the print head position as described above, [align the print head manually](#).

Aligning the Print Head Manually

If printed ruled lines are misaligned or print results are still not satisfactory after adjusting the print head position automatically, adjust the print head position manually.

►► Note

- Before adjusting the print head position manually, adjust the print head position automatically. For details on adjusting the print head position automatically, see [Aligning the Print Head](#).
- We recommend using the same type of paper for print head alignment as for printing.

You need to prepare: two sheets of A4 or Letter size paper

1. Make sure that the power is turned on.
2. Select **Maintenance** on the HOME screen, then press the **OK** button.

■ [LCD and Operation Panel](#)

The **Maintenance** screen will appear.

3. Select **Print head alignment**, then press the **OK** button.

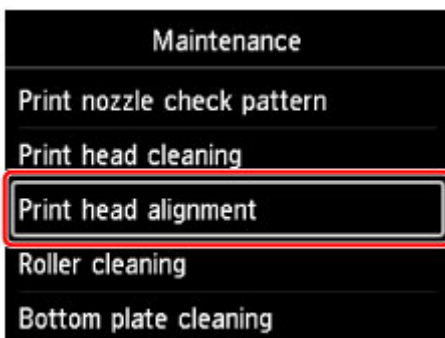

The **Print head alignment** screen will appear.

4. Select **Manual**, then press the **OK** button.

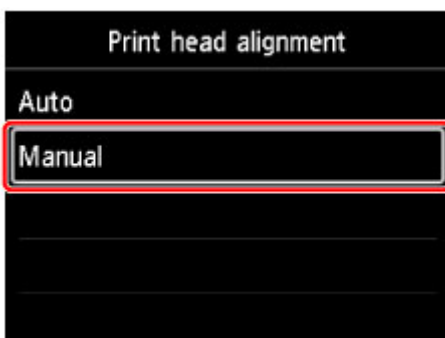

The confirmation screen will appear.

5. Select **Yes**, then press the **OK** button.

»» Note

- When the automatic print head alignment has not been performed, a message will appear. In this case, select **Yes**, press the **OK** button, then [perform the automatic print head alignment](#).

The paper settings screen will appear.

Specify **Page size** and **Type** for the paper to be used, select **Settings**, then press the **OK** button.

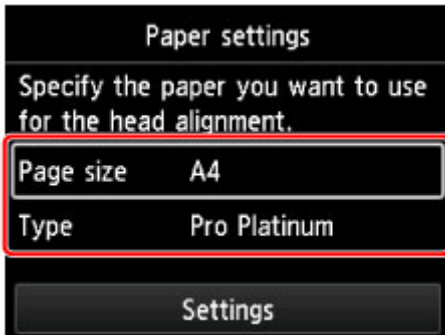

6. Load the prepared paper in the paper source specified in the message.

If the paper source is the manual feed tray, load one sheet of paper at a time.

7. Open the paper output tray gently.

Open the output tray extension, then pull out the paper output support.

8. Press the **OK** button.

The print head alignment pattern is printed.

9. When the message "**Did the patterns print correctly?**" appears, confirm that the pattern is printed correctly, select **Yes**, then press the **OK** button.

10. Confirm the message, then press the **OK** button.

The input screen for the head position adjustment values will appear.

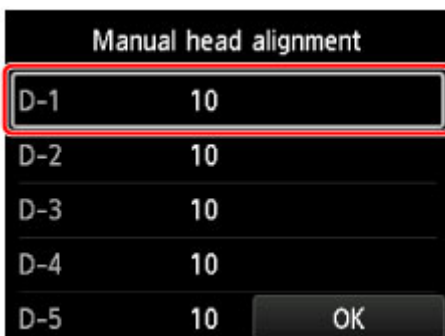

11. Look at the pattern and select the number of the pattern in each column that has straight lines.

Press the **OK** button to select a column, select the pattern number, then press the **OK** button.

* The sample of the first pattern is shown as below.

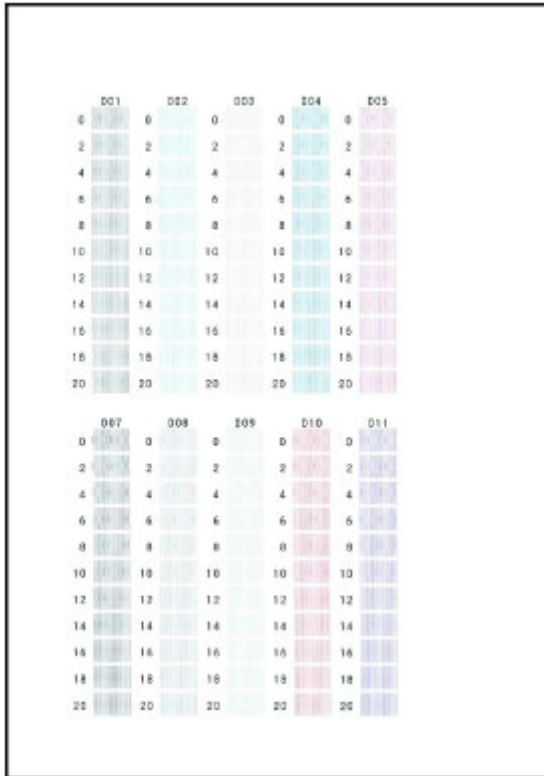

►► Note

- Look at the pattern and pick the setting that produces the least warped vertical straight lines.

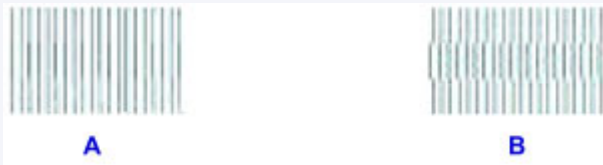

A: Vertical straight lines

B: Warped vertical straight lines

12. Repeat this procedure until you finish inputting a pattern number in all columns, select **OK**, then press the **OK** button.

If a message is displayed on the screen, follow the directions in the message.

13. When the completion message appears, press the **OK** button.

Color Management

- ▶ **Managing Colors**
- ▶ **Performing Color Calibration Using the Operation Panel**
- ▶ **Performing Color Calibration from Quick Utility Toolbox (Windows)**
- ▶ **Performing Color Calibration from Quick Utility Toolbox (Mac OS)**
- ▶ **Paper that Can Be Used in Color Calibration**

Managing Colors

Printer color management, color calibration, corrects for variations in color tones due to differences between printers and aging, and provides continuously consistent corrected color tones.

Use color calibration to correct the color tones of this printer.

If you have multiple printers, you can make the color tones of the printers the same by executing color calibration on each of the printers.

Color calibration can be executed using the operation panel or your computer.

■ [Performing Color Calibration Using the Operation Panel](#)

Use Quick Utility Toolbox to check when it is time to execute color calibration or to remotely execute color calibration.

■ [Executing Color Calibration from Quick Utility Toolbox \(Windows\)](#)

■ [Executing Color Calibration from Quick Utility Toolbox \(Mac OS\)](#)

To perform color calibration for paper other than genuine Canon paper, register the paper information with Media Configuration Tool.

■ [Media Configuration Tool Guide \(Windows\)](#)

Performing Color Calibration Using the Operation Panel

Use color calibration to correct color tones on printing paper.

►► Note

- Perform color calibration in the following cases:
 - After initial printer installation
 - If colors seem different from before, despite having the same environmental and printing conditions
 - To ensure uniform color when printing on multiple printers (However, be sure to use the same version of firmware and printer driver and the same settings.)
- We recommend performing color calibration using the same paper as you use for printing.
 - [Paper that Can Be Used in Color Calibration](#)
- Before performing color calibration, perform print head cleaning or print head alignment. This improves the precision of color calibration.

If the remaining ink level for an ink tank is low, [replace an ink tank](#).
- You can also perform color calibration using the computer.
 - Executing Color Calibration from Quick Utility Toolbox (Windows)
 - [Executing Color Calibration from Quick Utility Toolbox](#) (Mac OS)

1. Make sure that the power is turned on.

►► Important

- In order to increase the color stability precision when executing color calibration, maintain a constant temperature and humidity environment each time within the range of temperatures of 59 to 86°F (15 to 30°C) and within the range of humidities of 40 to 60%.

Executing color calibration under various temperature and humidity conditions may prevent the printers from making the correct adjustments.
- Before color calibration, ensure the printer is not exposed to direct sunlight or other strong sources of light. If the printer is exposed to strong sources of light, correct adjustment may not be possible.

2. Select **Maintenance** on the HOME screen, then press the **OK** button.

- [LCD and Operation Panel](#)

The **Maintenance** screen will appear.

3. Select **Color calibration**, then press the **OK** button.

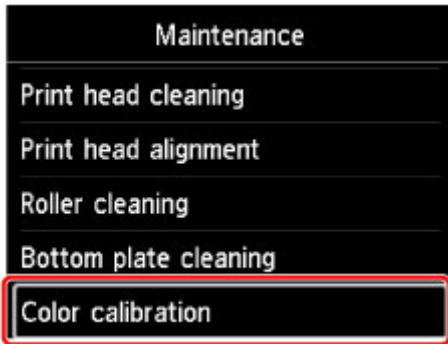

The **Color calibration** screen will appear.

4. Select **Auto adjust**, then press the **OK** button.

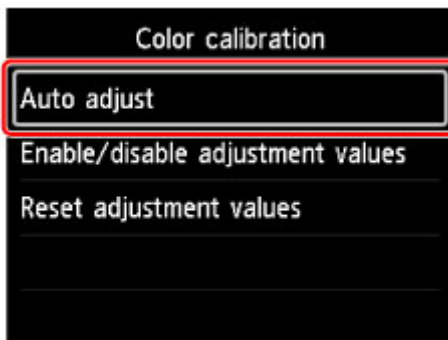

The confirmation screen will appear.

5. Select **Yes**, then press the **OK** button.

The paper settings screen will appear.

Specify **Page size** and **Type** for the paper to be used, select **Settings**, then press the **OK** button.

For details about paper, see [Paper that Can Be Used in Color Calibration](#).

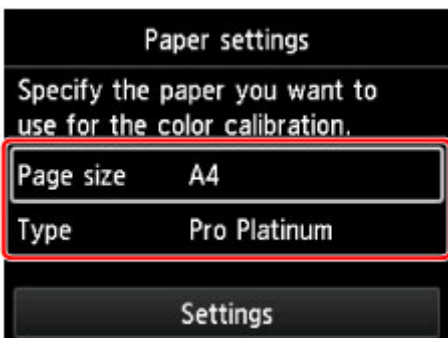

6. Load a single sheet of paper specified in step 5 in the rear tray.

▶▶▶ Important

- You cannot use the manual feed tray when performing color calibration.

7. Gently open the paper output tray.

Open the output tray extension, then pull out the paper output support.

8. Press the **OK** button.

After environmental measurements and paper are checked, color calibration is executed, automatically setting adjustment values.

▶▶▶ **Note**

- If color calibration was not executed correctly, an error message will appear on the LCD.

■ [Message Appears](#)

9. When the completion message appears, press the **OK** button.

▶▶▶ **Note**

- To apply color calibration adjustment values to printing, set them in the printer driver or at the operation panel. However, if the values set in the printer driver and the operation panel differ, the setting of the printer driver is prioritized.
- To enable or disable the color calibration adjustment values, select **Enable/disable adjustment values** on the **Color calibration** screen.
- To clear color calibration adjustment values, select **Reset adjustment values** in the **Color calibration** screen.

Performing Color Calibration from Quick Utility Toolbox

You can perform the following tasks related to color calibration for multiple printers connected by a network or USB using the Quick Utility Toolbox.

- Verifying recommended frequency of color calibration
- Executing color calibration
- Verifying progress of color calibration

▶▶▶Note

- Quick Utility Toolbox is a Canon software application.

▶▶▶Important

- You must load paper into the printer to perform color calibration.

For details on the paper that can be used for color calibration, see "Paper that Can Be Used in Color Calibration" for your model from the Home of the Online Manual.

1. In the Quick Utility Toolbox, select the printer for which you want to perform color calibration, and then click the **Calibration** button.

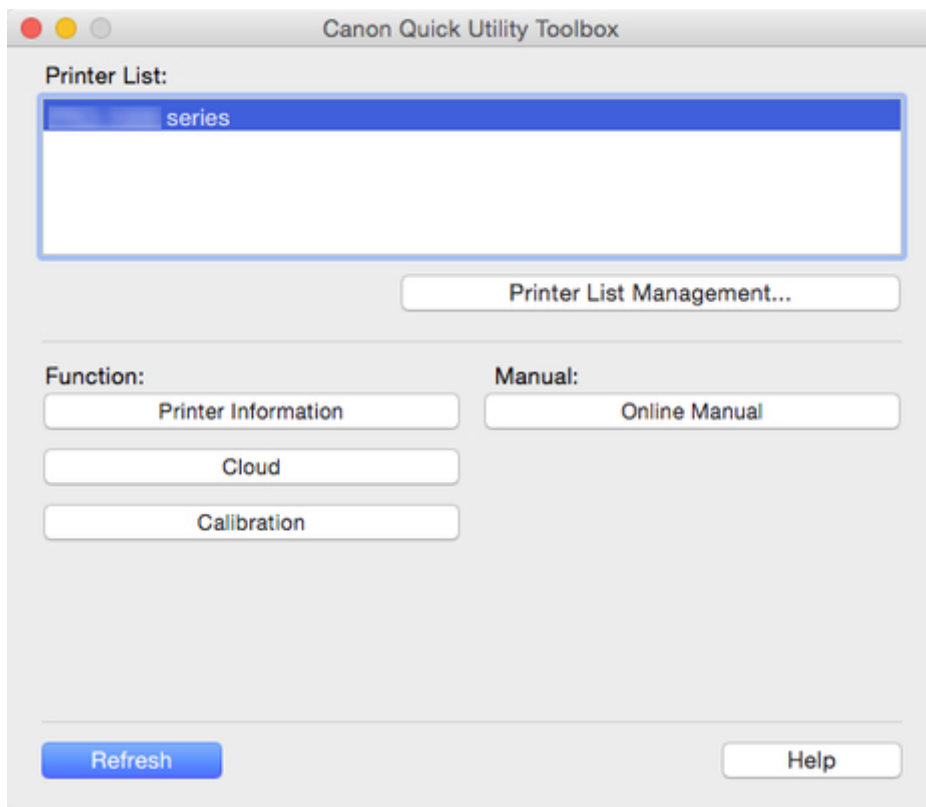

The **Calibration** dialog appears.

2. Select the **Media Type** for color calibration.

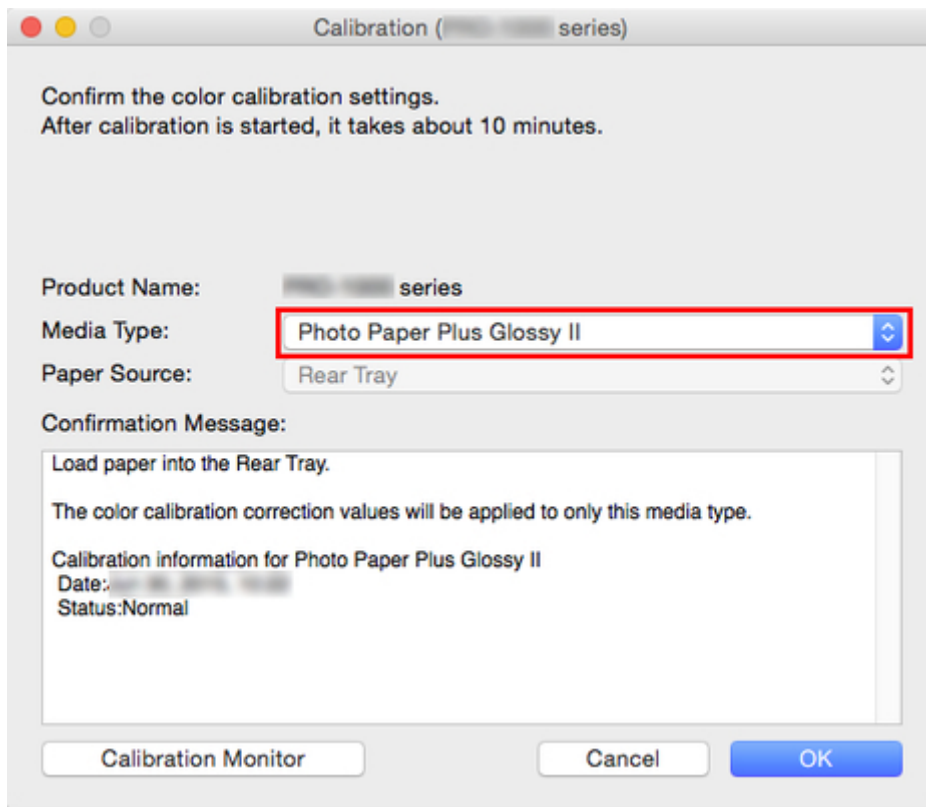

▶▶▶Note

- The media type for the paper fed on the printer appears depending on your model.

3. Verify the **Status** in the **Confirmation Message**.

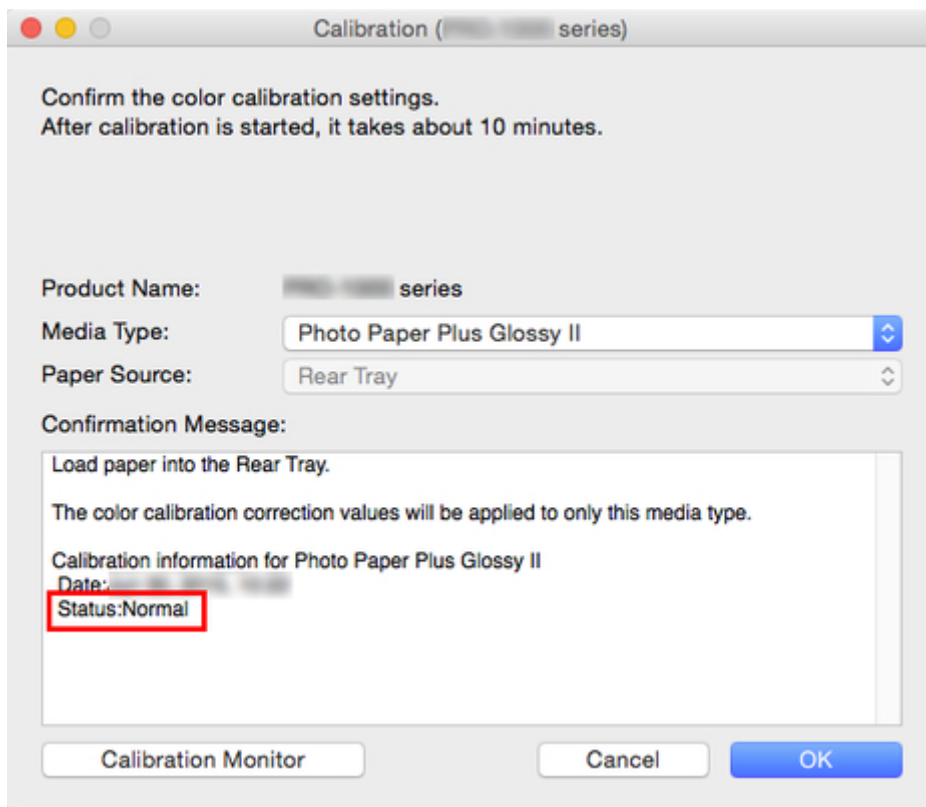

The **Status** in the **Confirmation Message** will let you know if color calibration is required.

►►► Important

- If you are not performing color calibration, click the **Cancel** button.
- Perform color calibration when replacing the printhead or when you are concerned about differences in color tone.

4. Verify the **Paper Source**.

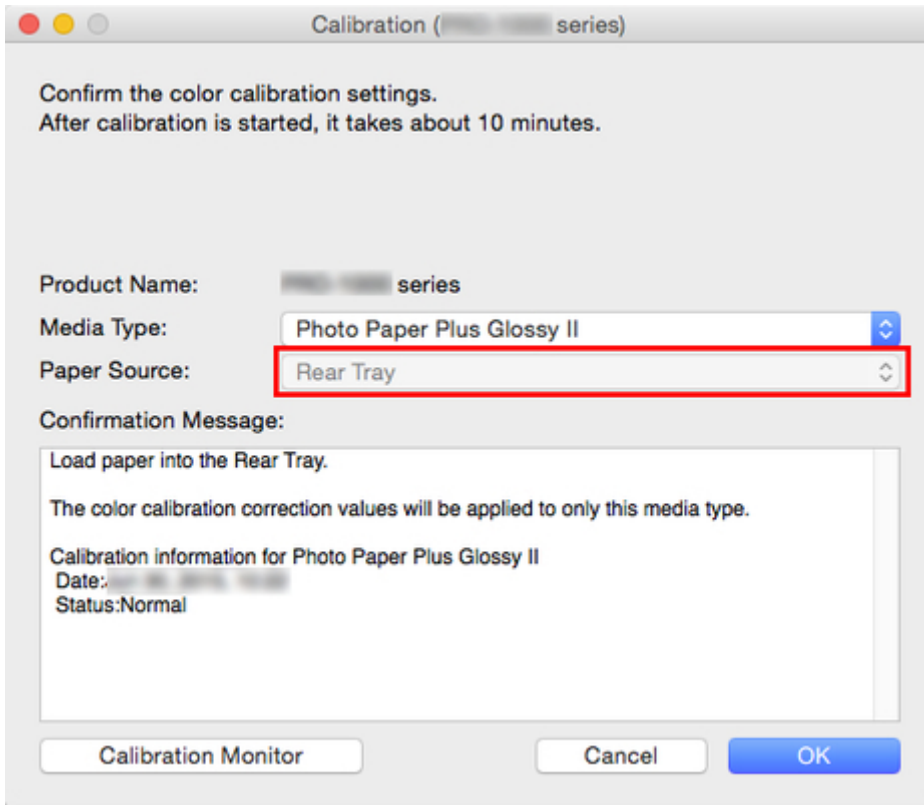

The paper sources for which color calibration can be performed are displayed for the paper in **Media Type**.

If the displayed paper source and the paper loaded to perform color calibration are different, reload the paper in the paper source displayed in **Paper Source**.

►►► Note



- Depending on your model, you can select the **Paper Source**.
- If you are using a PRO-1000 or PRO-500 model, only the rear tray can be used as the paper source for color calibration.

5. Click the **OK** button.

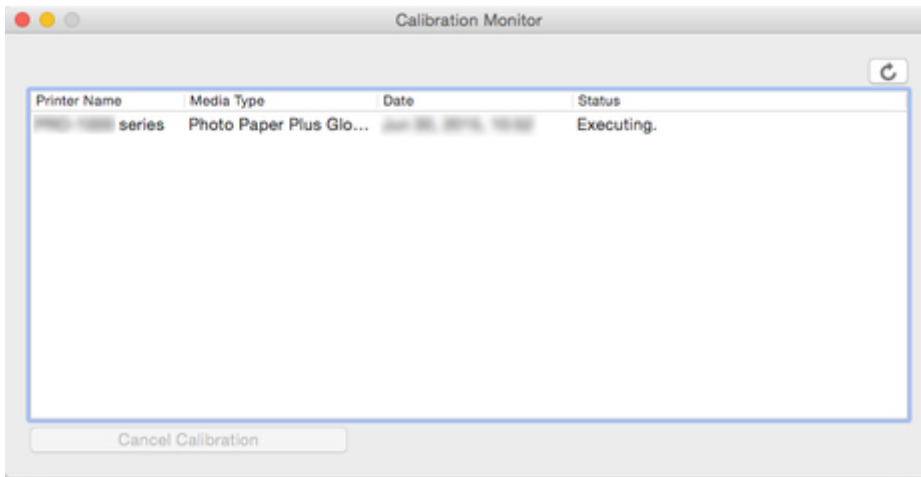
The color calibration starts and the **Calibration Monitor** dialog appears.



▶▶▶ Note

- If you want to stop the color calibration, select the printer and then click the **Cancel Calibration** button.
- Click the  button to update the color calibration progress status.
- To close this dialog, click the  button.

Paper that Can Be Used in Color Calibration

Color calibration has two adjustment types, Common calibration and Unique calibration, with one of these selected when color calibration is executed.

The selected adjustment type is determined from the media type that color calibration is executed on.

■ [Media Type and Adjustment Type](#)

Common Calibration

Common calibration is a feature that allows you to use multiple media types easily in a short time because it is not necessary to execute color calibration on each media type.

If color calibration is executed on paper categorized as Common calibration, dedicated calibration adjustment values are set on the media type that Common calibration was executed on.

Furthermore, calibration adjustment values are set on all print qualities for all media types where color calibration has not been executed.

▶▶▶ Note

- The calibration adjustment values are not overwritten for media types where color calibration has been executed once and dedicated calibration adjustment values have been set.

Example: Calibration is executed on media type A (adjustment type: Common).

Calibration values for media type A and media type B, for which dedicated calibration values have not been set, are applied.

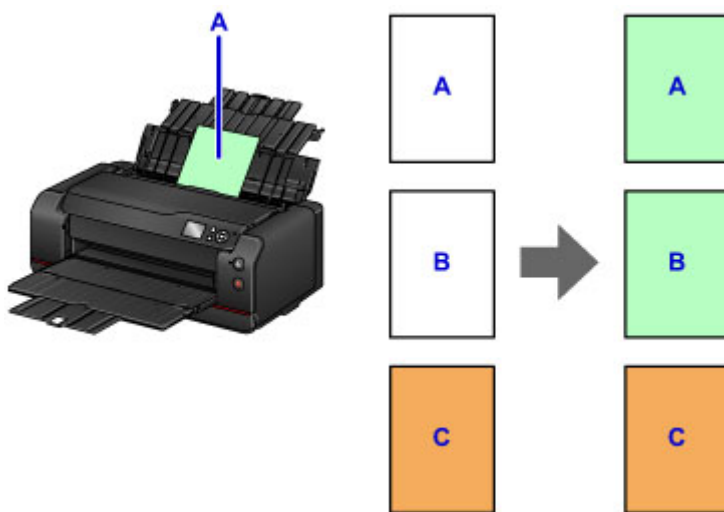

B: Media type to which dedicated calibration adjustment values are not set

C: Media type to which dedicated calibration adjustment values are set

Unique Calibration

If color calibration is executed on paper categorized as Unique calibration, calibration adjustment values are set only for the media type that the color calibration was executed on.

▶▶▶ Note

- Even if paper categorized as Unique calibration is used, if the media type has yet to execute color calibration even once and does not have any dedicated calibration adjustment values, the calibration adjustment values are overwritten when Common calibration is executed.

Example: Calibration is executed on media type D (adjustment type: Unique).

Calibration adjustment values are applied only to media type D.

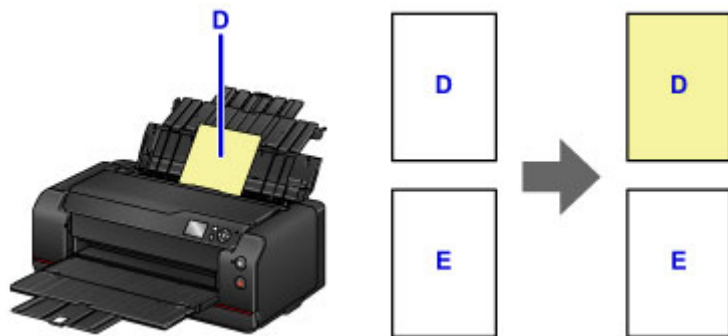

E: Media types other than D

Media Type and Adjustment Type

Media Name <Model No.>	Color Calibration Adjustment Type
Photo Paper Pro Platinum <PT-101>	Common calibration
Photo Paper Pro Luster <LU-101>	
Photo Paper Pro Premium Matte <PM-101>	
Photo Paper Plus Glossy II <PP-201>	Unique calibration
Photo Paper Plus Semi-gloss <SG-201>	
Matte Photo Paper <MP-101>	

* If the paper you are using is not in the above table, execute color calibration using the paper where the adjustment type is Common calibration, then you can set the calibration adjustment values for the paper you are using.

Page Sizes that Can Be Used

Page sizes that can be used in color calibration are as follows.

- Unused paper of A4 or Letter size

Maintenance and Consumables

▶ Maintenance Procedure

▶ Ink Tanks

- Ink
- Replacing Ink
- Checking the Ink Status with the LCD on the Printer

▶ Print Head

- Printing the Nozzle Check Pattern
- Examining the Nozzle Check Pattern
- Cleaning the Print Head
- Cleaning the Print Head Deeply
- Performing the System Cleaning

▶ Performing Maintenance Functions from Your Computer (Windows)

- Cleaning the Print Heads
- Printing a Nozzle Check Pattern

▶ Performing Maintenance Functions from Your Computer (Mac OS)

- Cleaning the Print Heads
- Printing a Nozzle Check Pattern
- Checking the Ink Status from Your Computer

▶ Maintenance Cartridge

- Replacing the Maintenance Cartridge
- Checking the Maintenance Cartridge Status with the LCD on the Printer

▶ Cleaning the Printer

- Cleaning the Exterior of the Printer
- Cleaning the Paper Feed Roller
- Cleaning the Inside of the Printer (Bottom Plate Cleaning)

▶ Other Maintenance

- Relocating Your Printer

- Transporting Your Printer

Maintenance Procedure

If print results are blurred, colors are not printed correctly, or print results are unsatisfactory (e.g. misaligned printed ruled lines), perform the maintenance procedure below.

▶▶▶ Important

- Do not rinse or wipe the print head and ink tank. This can cause trouble with the print head and ink tank.

▶▶▶ Note

- Check the ink status on the HOME screen or other screens.
If the ink is running low, take appropriate action.
 - [Checking the Ink Status with the LCD on the Printer](#)
- Increasing the print quality in the printer driver settings may improve the print result.
 - [Changing the Print Quality and Correcting Image Data \(Windows\)](#)
 - [Changing the Print Quality and Correcting Image Data \(Mac OS\)](#)

When the Print Results Are Blurred or Uneven:

|| Step1 | Print the nozzle check pattern.

From the printer

- [Printing the Nozzle Check Pattern](#)

From the computer

- [Printing a Nozzle Check Pattern \(Windows\)](#)
- [Printing a Nozzle Check Pattern \(Mac OS\)](#)

|| Step2 | [Examine the nozzle check pattern.](#)

If there are missing lines or horizontal white streaks in the pattern:



|| Step3 | Clean the print head.

From the printer

- [Cleaning the Print Head](#)

From the computer

- [Cleaning the Print Heads \(Windows\)](#)
- [Cleaning the Print Heads \(Mac OS\)](#)

After cleaning the print head, print and examine the nozzle check pattern: ➔ [Step1](#)

If the problem is not resolved after performing from step 1 to step 3 twice:



|| Step4 | Clean the print head deeply.

From the printer

- [Cleaning the Print Head Deeply](#)

From the computer

- [Cleaning the Print Heads \(Windows\)](#)
- [Cleaning the Print Heads \(Mac OS\)](#)

If the problem is not resolved after performing step 4:



|| Step5 Perform the system cleaning.

From the printer

- [Performing the System Cleaning](#)

From the computer

- [Cleaning the Print Heads \(Windows\)](#)
- [Cleaning the Print Heads \(Mac OS\)](#)

▶▶▶ Note

- When you have performed the procedure until step 5 and the problem has not been resolved, turn off the power and clean the print head deeply again after 24 hours.
If the problem is still not resolved, the print head may be damaged. Contact the service center.

When the Print Results Are Not Even such as the Ruled Lines Are Misaligned:

|| Step [Align the print head.](#)

Ink Tanks

- ▶ **Ink**
- ▶ **Replacing Ink**
- ▶ **Checking the Ink Status with the LCD on the Printer**

Ink

Ink is used for various purposes other than printing.

Ink may be used for purposes other than printing.

When you use the Canon printer for the first time after you install the bundled ink tanks, the printer consumes a small amount of ink in the amount to enable printing by filling the nozzles of the Print Head with ink. For this reason, the number of sheets that can be printed with the first ink tanks is fewer than the succeeding ink tanks.

The printing costs described in the brochures or websites are based on the consumption data from not the first ink tank /ink cartridge but the succeeding ink tank /ink cartridge.

Ink is sometimes used to maintain the optimal printing quality.

To keep printer's performance, Canon printer performs cleaning automatically according to its condition. When the printer performs cleaning, a small amount of ink is consumed. In this case, all colors of ink may be consumed.

[Cleaning function]

The cleaning function helps the printer to suck air bubbles or ink itself from the nozzle and thus prevents print quality degradation or nozzle clogging.

In addition to cleaning the print head, the printer automatically performs the system cleaning at regular intervals to prevent trouble such as unwanted lines or the complete stopping of ink ejection.

If the remaining ink level is low, the system cleaning may not be performed automatically. Follow the message displayed on the LCD to replace the deficient ink tank with a new one.

There will be some ink remaining in the ink tank removed for replacement to perform the system cleaning.

►► Important

- The used ink is ejected into the maintenance cartridge. When the maintenance cartridge becomes full, replacement is necessary. If the displayed message indicates that the maintenance cartridge is nearly full, promptly obtain a new one.

■ [Replacing the Maintenance Cartridge](#)

- A certain amount of ink is consumed in regular operations performed automatically to keep printer performance, such as print preparation, ink path bubble removal and print head cleaning. The maintenance cartridge is also consumed for this operation.
- When using the printer for the first time after installing the ink tanks which are bundled with the printer, a certain amount of ink is consumed to set up the printer for printing. For this reason, the printable volume of the ink tanks which are bundled with the printer will be less than that of subsequent replacements. Since the maintenance cartridge is filled with the ink which is ejected for the initial set up mentioned above and its remaining capacity is consumed approximately 50%, the timing of replacing the maintenance cartridge becomes sooner than that of subsequent replacements.

Black-and-white printing uses color ink.

Black-and-white printing may use ink other than black ink depending on the type of printing paper or the settings of the printer driver. So, color ink is consumed even when printing in black-and-white.

»» Note

- CO (Chroma Optimizer) ink is applied onto the print side of paper to adjust glossiness. This ink is also consumed in order to keep printer's performance and ensure good print quality, even when not applied onto the print side.
- The printer uses pigment ink. Due to the nature of the pigment ink, the ink on the printed surface may be removed when being rubbed or scratched.

Replacing Ink

In case of cautions or errors concerning remaining ink level, an error message will appear on the LCD to inform you of the error. Take appropriate action as prompted by the message.

■ [Message Appears](#)

▶▶▶ Note

- If print results become faint or white streaks appear despite sufficient ink levels, see [Maintenance Procedure](#).
- For precautionary notes on handling ink tanks, see [Notes on ink tanks](#).

Replacing Procedure

When you need to replace an ink tank, follow the procedure below.

1. Make sure that the power is turned on, then display the HOME screen.

If the HOME screen is not displayed, press the **HOME** button.

2. Select the ink status display area on the HOME screen, then press the **OK** button.

■ [LCD and Operation Panel](#)

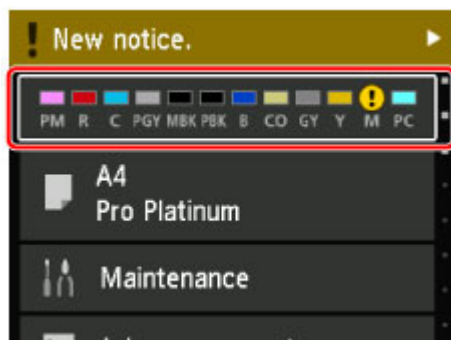

The **Current estimated ink levels** screen will appear.

3. Select **Replace**, then press the **OK** button.

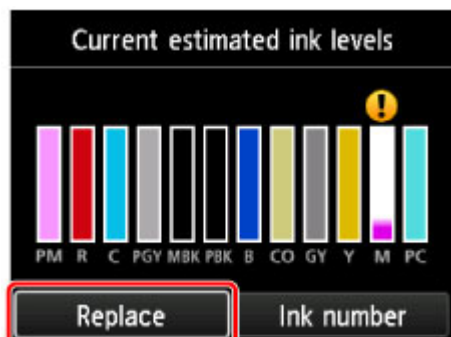

4. Check the message, then open the tank cover.



5. Remove the ink tank to be replaced.

To remove the ink tank, push the mark (PUSH) in front of the ink tank until it clicks.

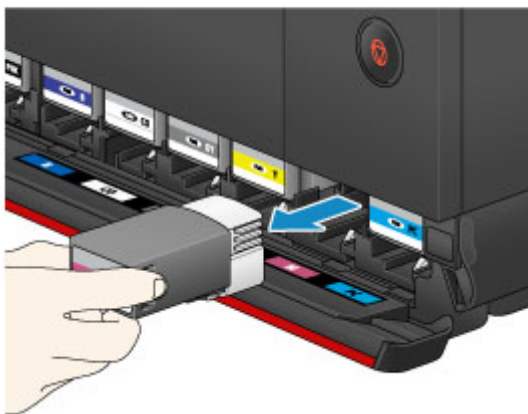

»» Important

- Do not place the removed ink tanks with the open ink port down. Ink on the open ink port may stain your desk or other things.

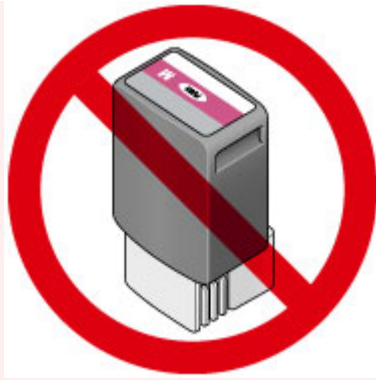

- Do not touch the metallic parts or other parts inside the printer.
- Do not touch other parts besides the ink tanks.
- Handle the ink tank carefully to avoid staining of clothing or the surrounding area.
- Discard the empty ink tank according to the local laws and regulations regarding disposal of consumables.

▶▶▶ Note

- Do not remove two or more ink tanks at the same time. Be sure to replace ink tanks one by one when replacing two or more ink tanks.

6. Before taking a new ink tank out of its package, shake it five to six times horizontally.

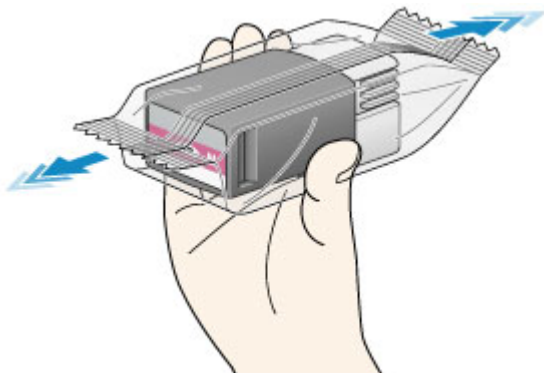

▶▶▶ Important

- Handle an ink tank carefully. Do not drop or apply excessive pressure to it.

▶▶▶ Note

- Instead of shaking ink tanks, you can set the printer to automatically mix the ink after ink tank replacement.

■ [Auto maintenance settings \(Item for administrator\)](#)

7. Take the ink tank out of its package.

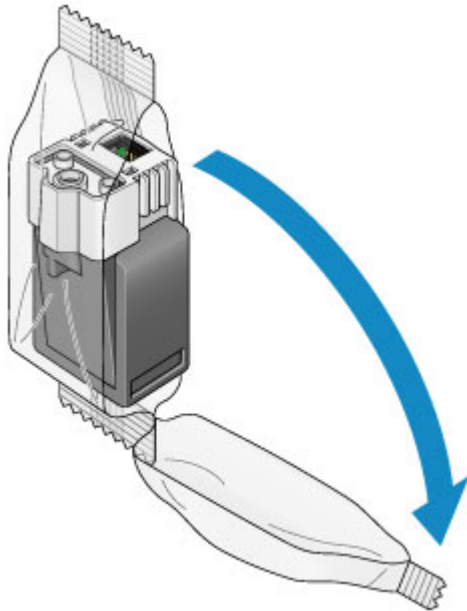

►► Important

- Do not touch the contact (A) or joint (B) of the ink tank.

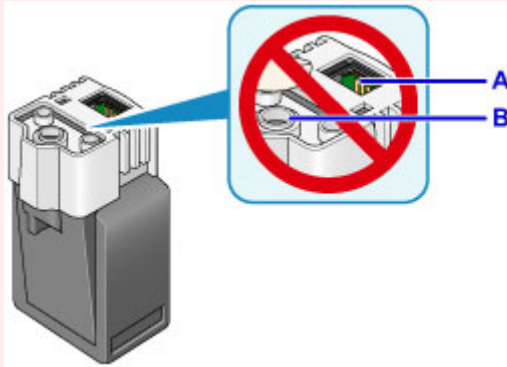

8. Insert the new ink tank straight into the slot.

Make sure that the position of the ink tank matches the label.

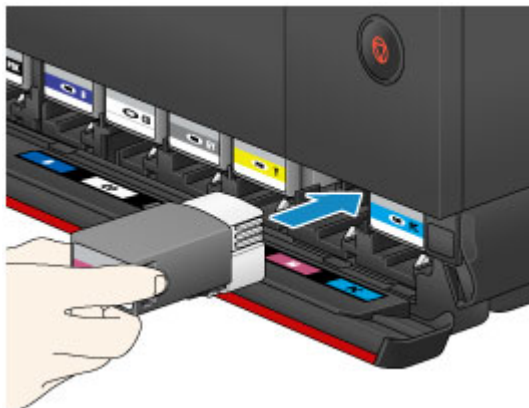

9. Firmly push the mark (PUSH) in front of the ink tank until it clicks into place.

After installing the new ink tank, the corresponding ink lamp indication on the LCD comes on.



»» Important

- Ink tanks are designed so that they cannot be inserted in incorrect locations. Be sure to install the ink tank in its correct location.
- You cannot print unless all the ink tanks are installed. Be sure to install all the ink tanks.
- Once an ink tank is installed, do not remove it until the next replacement. If you remove an ink tank with enough ink remaining in it, ink may spill out of it.

10. Close the tank cover.

When a message is displayed on the LCD, press the **OK** button.

»» Note

- After closing the tank cover, the printer starts loading ink. This takes up to about 1 to 2 minutes. If you have set the printer to automatically mix ink, the printer then starts automatically mixing the ink. This takes about 2 minutes. Wait until the completion message appears on the LCD.
- The printer may make noise while mixing ink.
- If the error message appears on the LCD after the tank cover is closed, take appropriate action.

■ [Message Appears](#)

Notes on ink tanks

»» Important

- If you remove an ink tank, replace it immediately. Do not leave the printer with the ink tank removed.
- Use a new ink tank for replacement. Installing a used ink tank may cause the nozzles to clog. Furthermore, with such an ink tank, the printer will not be able to inform you when to replace the ink tank properly.
- Once an ink tank has been installed, do not remove it from the printer and leave it out in the open. This will cause the ink tank to dry out, and the printer may not operate properly when it is reinstalled. To maintain optimal printing quality, use an ink tank within six months of first use.

»» Note

- Color ink may be consumed even when printing a black-and-white document or when black-and-white printing is specified. Every ink is also consumed in the cleaning, deep cleaning, and system cleaning of the print head, which may be necessary to maintain the performance of the printer.

When an ink tank is out of ink, replace it immediately with a new one.

■ [Ink](#)

Checking the Ink Status with the LCD on the Printer

1. Make sure that the power is turned on, and display the HOME screen.

If the HOME screen is not displayed, press the **HOME** button.

2. Select the ink status display area on the HOME screen, then press the **OK** button.

■ LCD and Operation Panel

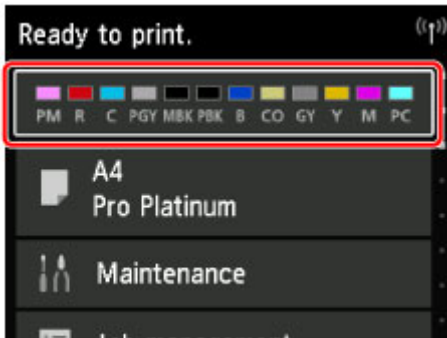

3. Check the ink status.

A symbol appears in the area A if there is any information about the remaining ink level.



Example: ⚠

The ink is running low. Prepare a new ink tank.

▶▶▶ Note

- The above screen shows estimated ink levels.
- Selecting **Ink number** displays the **Ink number** screen for checking ink tank numbers. Selecting **Print no.** on this screen enables you to print ink tank numbers.
- To replace ink tanks, select **Replace**.

■ [Replacing Ink](#)

- You can also check the ink status on the HOME screen.
- You can check the ink status on the computer screen.

■ [Checking the Ink Status from Your Computer \(Windows\)](#)

■ [Checking the Ink Status from Your Computer \(Mac OS\)](#)

Print Head

- ▶ **Printing the Nozzle Check Pattern**
- ▶ **Examining the Nozzle Check Pattern**
- ▶ **Cleaning the Print Head**
- ▶ **Cleaning the Print Head Deeply**
- ▶ **Performing the System Cleaning**

Printing the Nozzle Check Pattern

Print the nozzle check pattern to determine whether the ink ejects properly from the print head nozzle.

▶▶▶ Note

- If the remaining ink level is low, the nozzle check pattern will not be printed correctly. [Replace the ink tank](#) whose ink is low.

You need to prepare: a single sheet of A4 or Letter size plain paper

1. Make sure that the power is turned on.
2. Load a single sheet of A4 or Letter size plain paper in the rear tray.

After loading paper, the paper information registration screen for the rear tray is displayed. Select **A4** or **Letter** for **Page size** and **Plain paper** for **Type**, select **Register**, then press the **OK** button.

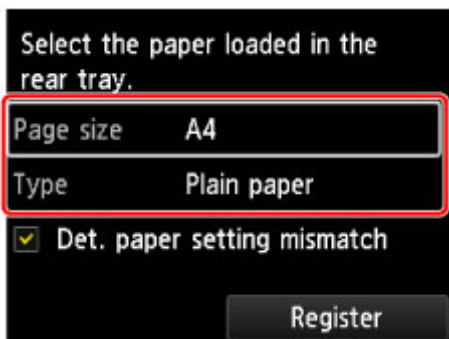

If a message is displayed on the screen, follow the directions in the message to complete registration.

▶▶▶ Important

- The manual feed tray is not available for the nozzle check pattern print procedure. Be sure to load paper in the rear tray.

3. Open the paper output tray gently.
Open the output tray extension gently, then pull out the paper output support.
4. Select **Maintenance** on the HOME screen, then press the **OK** button.

■ [LCD and Operation Panel](#)

The **Maintenance** screen will appear.

5. Select **Print nozzle check pattern**, then press the **OK** button.

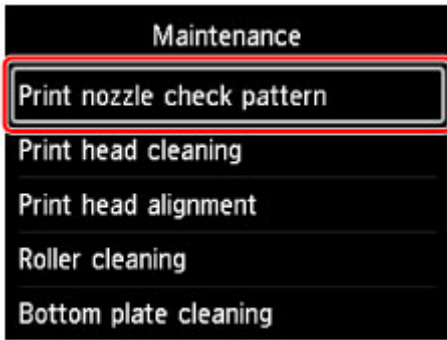

The confirmation screen will appear.

6. Select **Yes**, then press the **OK** button.

The nozzle check pattern will be printed and two pattern confirmation screens will appear on the LCD.

7. [Examine the nozzle check pattern.](#)

Examining the Nozzle Check Pattern

Examine the nozzle check pattern, and clean the print head if necessary.

1. Check if there are missing lines in pattern C or horizontal streaks in pattern D.

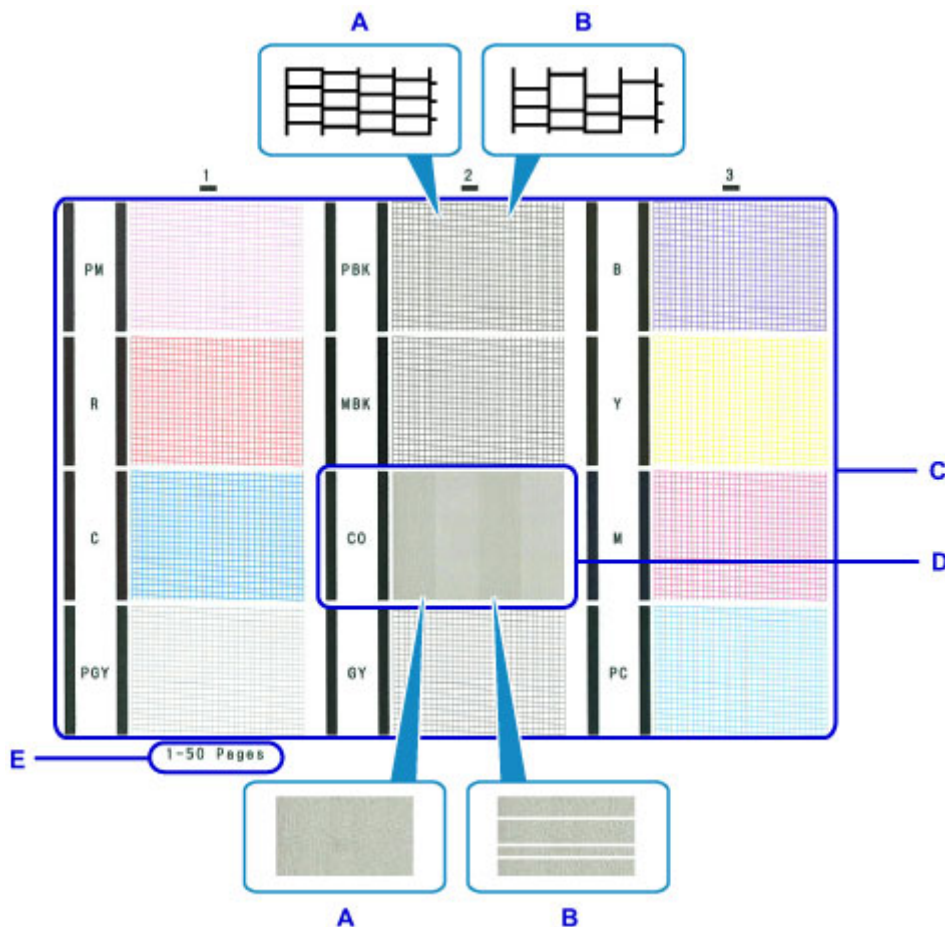

A: No missing lines/No horizontal streaks

B: Lines are missing/Horizontal streaks are present

E: Number of sheets printed so far

2. Select the pattern that is closer to the printed nozzle check pattern on the confirmation screen.

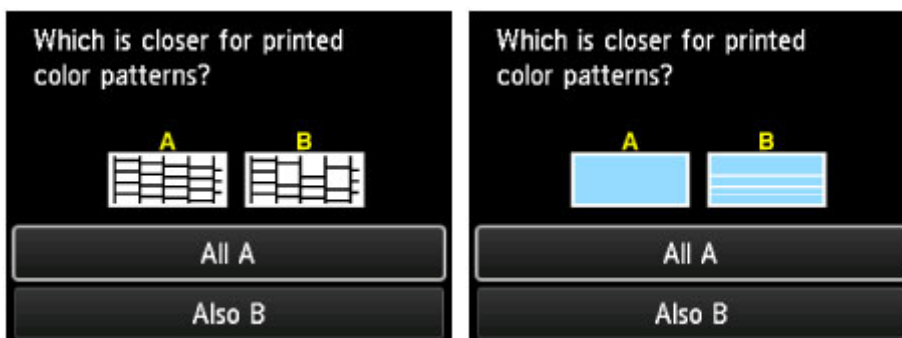

If pattern C has no missing lines in all three groups and pattern D has no horizontal streaks (A):

Cleaning is not required. Select **All A**, then press the **OK** button.

Confirm the message, then press the **OK** button.

The screen will return to the **Maintenance** screen.

If pattern C has missing lines in any of the three groups or pattern D has horizontal streaks (B):

Cleaning is required. Select **Also B**, then press the **OK** button.

Select **Yes** on the cleaning confirmation screen, then press the **OK** button.

The printer starts cleaning the print head.

■ [Cleaning the Print Head](#)

▶▶▶ **Note**

- Because CO ink is colorless, its pattern is printed over the MBK ink pattern. Check for horizontal streaks (F) in the dark gray bands of the pattern.

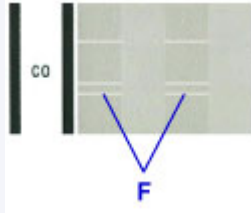

▶▶▶ **Note**

- The total number of sheets printed so far is shown in increments of 50 sheets on the printout of the nozzle check pattern.

Cleaning the Print Head

Clean the print head if lines are missing or if horizontal streaks are present in the printed nozzle check pattern. Cleaning unclogs the nozzles and restores the print head condition. Cleaning the print head consumes ink, so clean the print head only when necessary.

»» Note

- You can also clean the print head using the computer. When using the computer, select the ink group to clean, then start cleaning.

- [Cleaning the Print Heads \(Windows\)](#)
- [Cleaning the Print Heads \(Mac OS\)](#)

When cleaning the print head using the printer, the nozzles of all ink colors are cleaned.

You need to prepare: a single sheet of A4 or Letter size plain paper

1. Make sure that the power is turned on.
2. Load a single sheet of A4 or Letter size plain paper in the rear tray.

After loading the paper, the paper information registration screen for the rear tray is displayed. Select **A4** or **Letter** for **Page size** and **Plain paper** for **Type**, select **Register**, then press the **OK** button.

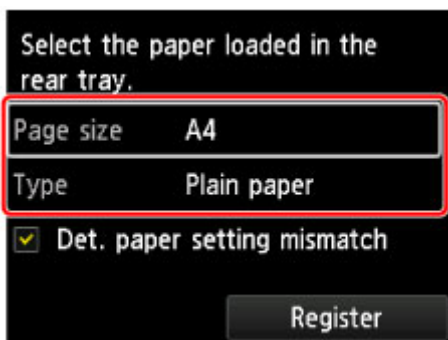

If a message is displayed on the screen, follow the directions in the message to complete registration.

»» Important

- The manual feed tray is not available for the nozzle check pattern print procedure. Be sure to load paper in the rear tray.

3. Open the paper output tray gently.
Open the output tray extension gently, then pull out the paper output support.
4. Select **Maintenance** on the HOME screen, then press the **OK** button.
■ [LCD and Operation Panel](#)
The **Maintenance** screen will appear.
5. Select **Print head cleaning**, then press the **OK** button.

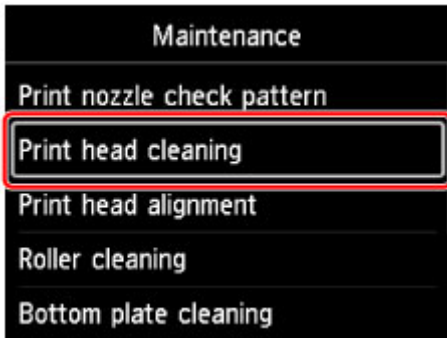

The **Print head cleaning** screen will appear.

6. Select **Cleaning**, then press the **OK** button.

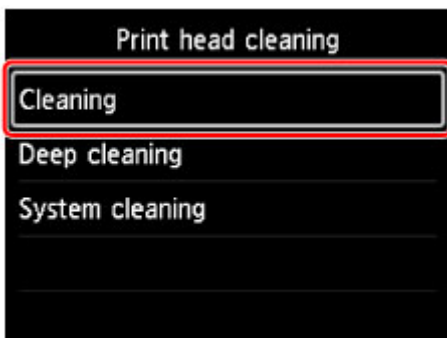

The confirmation screen will appear.

7. Select **Yes**, then press the **OK** button.

The printer starts cleaning the print head.

Do not perform any other operations until the printer completes the cleaning of the print head. This takes about 6 minutes.

The pattern print confirmation screen will appear.

8. Select **Yes**, then press the **OK** button.

The nozzle check pattern will be printed.

9. [Examine the nozzle check pattern.](#)

»» Note

- If the problem is not resolved after cleaning the print head twice, [clean the print head deeply.](#)

Cleaning the Print Head Deeply

If print quality does not improve by the standard cleaning of the print head, clean the print head deeply. Cleaning the print head deeply consumes more ink than the standard cleaning of the print head, so clean the print head deeply only when necessary.

▶▶▶ Note

- You can also clean the print head deeply using the computer. When using the computer, select the ink group to clean, then start cleaning.

- [Cleaning the Print Heads \(Windows\)](#)
- [Cleaning the Print Heads \(Mac OS\)](#)

When cleaning the print head using the printer, the nozzles of all ink colors are cleaned.

You need to prepare: a single sheet of A4 or Letter size plain paper

1. Make sure that the power is turned on.
2. Load a single sheet of A4 or Letter size plain paper in the rear tray.

After loading the paper, the paper information registration screen for the rear tray is displayed. Select **A4** or **Letter** for **Page size** and **Plain paper** for **Type**, select **Register**, then press the **OK** button.

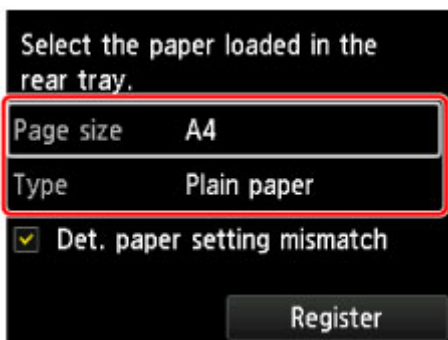

If a message is displayed on the screen, follow the directions in the message to complete registration.

▶▶▶ Important

- The manual feed tray is not available for the nozzle check pattern print procedure. Be sure to load paper in the rear tray.

3. Open the paper output tray gently.
Open the output tray extension gently, then pull out the paper output support.
4. Select **Maintenance** on the HOME screen, then press the **OK** button.
■ [LCD and Operation Panel](#)
The **Maintenance** screen will appear.
5. Select **Print head cleaning**, then press the **OK** button.

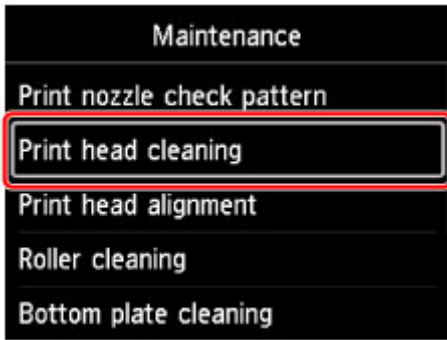

The **Print head cleaning** screen will appear.

6. Select **Deep cleaning**, then press the **OK** button.

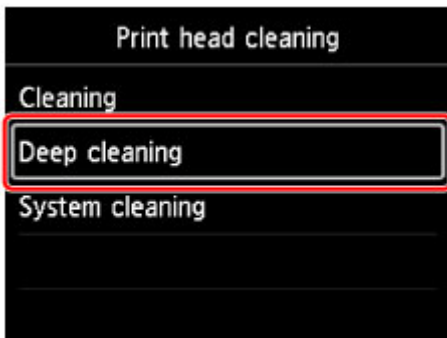

The confirmation screen will appear.

7. Select **Yes**, then press the **OK** button.

The printer starts cleaning the print head deeply.

Do not perform any other operations until the printer completes the deep cleaning of the print head. This takes about 6 minutes.

The pattern print confirmation screen will appear.

8. Select **Yes**, then press the **OK** button.

The nozzle check pattern will be printed.

9. When the completion message appears, press the **OK** button.

10. [Examine the nozzle check pattern.](#)

If a particular color is not printed properly, [replace the ink tank](#) of that color.

▶▶▶ Note

- If the deep cleaning does not resolved the problem, [perform the system cleaning.](#)

Performing the System Cleaning

If print quality is not improved by deep cleaning of the print head, perform system cleaning. System cleaning consumes a great amount of ink. Frequent system cleaning can rapidly consume ink, so perform system cleaning only when necessary.

»»» Important

- When performing system cleaning, be sure to check the used space of the maintenance cartridge. System cleaning consumes a great amount of space. If the maintenance cartridge does not have enough space, [replace the maintenance cartridge](#) with a new one. If the maintenance cartridge does not have enough space, a message will appear and system cleaning will be disabled.

»»» Note

- You can also perform system cleaning using the computer. When using the computer, select the ink group to clean, then start cleaning.

- [Cleaning the Print Heads \(Windows\)](#)
- [Cleaning the Print Heads \(Mac OS\)](#)

When cleaning the print head using the printer, the nozzles of all ink colors are cleaned.

You need to prepare: a single sheet of A4 or Letter size plain paper

1. Make sure that the power is turned on.
2. Load a single sheet of A4 or Letter size plain paper in the rear tray.

After loading the paper, the paper information registration screen for the rear tray is displayed. Select **A4** or **Letter** for **Page size** and **Plain paper** for **Type**, select **Register**, then press the **OK** button.

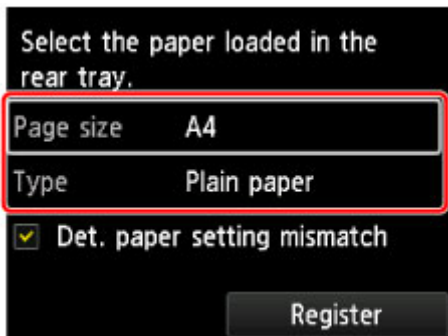

If a message is displayed on the screen, follow the directions in the message to complete registration.

»»» Important

- The manual feed tray is not available for the nozzle check pattern print procedure. Be sure to load paper in the rear tray.

3. Open the paper output tray gently.
Open the output tray extension gently, then pull out the paper output support.
4. Select **Maintenance** on the HOME screen, then press the **OK** button.

- [LCD and Operation Panel](#)

The **Maintenance** screen will appear.

5. Select **Print head cleaning**, then press the **OK** button.

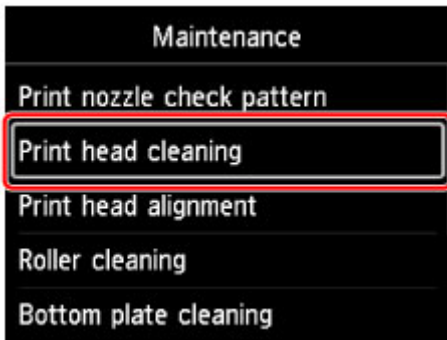

The **Print head cleaning** screen will appear.

6. Select **System cleaning**, then press the **OK** button.

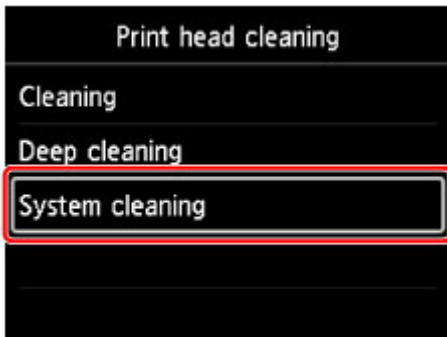

The confirmation screen will appear.

7. Select **Yes**, then press the **OK** button.

The printer starts system cleaning of the print head.

Do not perform any other operations until the printer completes system cleaning of the print head. This takes about 6 minutes.

The pattern print confirmation screen will appear.

8. Select **Yes**, then press the **OK** button.

The nozzle check pattern will be printed.

9. When the completion message appears, press the **OK** button.

10. [Examine the nozzle check pattern.](#)

If the problem is not resolved after performing system cleaning, turn off the power and clean the print head deeply again after 24 hours.

If the problem is still not resolved, the print head may be damaged. Contact the service center.

Performing Maintenance Functions from Your Computer (Mac OS)

- ▶ **Cleaning the Print Heads**
- ▶ **Printing a Nozzle Check Pattern**
- ▶ **Checking the Ink Status from Your Computer**

Cleaning the Print Heads

The print head cleaning and deep cleaning functions allow you to clear up clogged print head nozzle. Perform print head cleaning if printing is faint or a specific color fails to print, even though there is enough ink.

If you perform deep cleaning and the condition still does not improve, perform system cleaning.

The procedure for cleaning is as follows:



Cleaning

1. Select **Cleaning** from the pop-up menu on the [Canon IJ Printer Utility2](#)

2. Click the **Cleaning** icon

When the dialog opens, select the ink group for which cleaning is to be performed.

Before running the cleaning, check the following items:

On some printer models, pressing the tank cover open button on the printer opens the tank cover.

Check the following items for each ink. Then, if necessary, perform **Cleaning**.

- [Is there ink remaining in the tank?](#)
- Did you push in the ink tank completely until you heard a clicking sound?
- If the orange tape is there, has it been peeled off completely?
Any remaining tape will hinder ink output.
- Did you install the ink tanks in their correct positions?

3. Execute cleaning

Make sure that the printer is on and then click **OK**.

Print head cleaning starts.

4. Complete cleaning

Next, the message for nozzle check pattern printing is displayed.

5. Check the results

To check whether the print quality has improved, click **Print Check Pattern**. To cancel the check process, click **Cancel**.

If cleaning the head once does not resolve the print head problem, clean it once more.

»» Important

- **Cleaning** consumes a small amount of ink.
Cleaning the print head frequently will rapidly deplete your printer's ink supply. Consequently, perform cleaning only when necessary.



Deep Cleaning

Deep Cleaning is more thorough than cleaning. Perform deep cleaning when two **Cleaning** attempts do not resolve the print head problem.

1. Select **Cleaning** from the pop-up menu on the [Canon IJ Printer Utility2](#)

2. Click the **Deep Cleaning** icon

When the dialog opens, select the ink group for which deep cleaning is to be performed.

Before running the forced cleaning, check the following items:

On some printer models, pressing the tank cover open button on the printer opens the tank cover.

Check the following items for each ink. Then, if necessary, perform **Deep Cleaning**.

- [Is there ink remaining in the tank?](#)
- Did you push in the ink tank completely until you heard a clicking sound?
- If the orange tape is there, has it been peeled off completely?
Any remaining tape will hinder ink output.
- Did you install the ink tanks in their correct positions?

3. Execute deep cleaning

Make sure that the printer is on and then click **OK**.

Click **OK** when the confirmation message appears.

Print head deep cleaning starts.

4. Complete deep cleaning

The **Nozzle Check** dialog opens after the confirmation message.

5. Check the results

To check whether the print quality has improved, click **Print Check Pattern**. To cancel the check process, click **Cancel**.

▶▶▶ Important

- **Deep Cleaning** consumes a larger amount of ink than **Cleaning**.
Cleaning the print head frequently will rapidly deplete your printer's ink supply. Consequently, perform cleaning only when necessary.

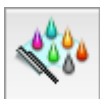

System Cleaning

Execute **System Cleaning** if the status does not improve even after **Deep Cleaning** is performed.

1. Select **Cleaning** from the pop-up menu on the [Canon IJ Printer Utility2](#)

2. Click the **System Cleaning** icon

When the dialog opens, select the ink group for which system cleaning is to be performed.

Before running the system cleaning, check the following items:

Check that the printer power is on. Then press the tank cover open button on the printer and open the tank cover.

Check the following items for each ink.

- [Is there ink remaining in the tank?](#)
- Did you push in the ink tank completely until you heard a clicking sound?
- If the orange tape is there, has it been peeled off completely?
Any remaining tape will hinder ink output.
- Did you install the ink tanks in their correct positions?

In addition, **System Cleaning** consumes an extremely large amount of ink.

Before executing this function, check the items below. Then, if you feel it necessary, execute **System Cleaning**.

- Did you use **Nozzle Check** to check the nozzle status and was there a problem?
- Did the status remain unchanged even after **Deep Cleaning** was executed?

3. Execute system cleaning

Make sure that the printer is on and then click **OK**.

Click **OK** when the confirmation message appears.

System cleaning starts.

4. Complete system cleaning

The **Nozzle Check** dialog opens after the confirmation message.

5. Check the results

To check whether the print quality has improved, click **Print Check Pattern**. To cancel the check process, click **Cancel**.

▶▶▶ Important

- **System Cleaning** consumes an extremely large amount of ink.
Executing system cleaning frequently will rapidly deplete your printer's ink supply. Therefore, execute system cleaning only when necessary.

▶▶▶ Note

- If there is no sign of improvement after **System Cleaning**, turn off the printer, wait 24 hours, and then perform **Deep Cleaning** again. If there is still no sign of improvement, the ink may have run out or the print head may be worn. For details on the remedial action to be taken, see "No Ink Comes Out."

Related Topic

- [Printing a Nozzle Check Pattern](#)

Printing a Nozzle Check Pattern

The nozzle check function allows you to check whether the print head is working properly by printing a nozzle check pattern. Print the pattern if printing becomes faint, or if a specific color fails to print.

The procedure for printing a nozzle check pattern is as follows:



Nozzle Check

1. Select **Test Print** from the pop-up menu on the [Canon IJ Printer Utility2](#)

2. Click the **Nozzle Check** icon

The confirmation message appears.

Before printing the nozzle check pattern, check the following items:

On some printer models, pressing the tank cover open button on the printer opens the tank cover. Check the following items for each ink. Then, if necessary, perform **Nozzle Check**.

- [Is there ink remaining in the tank?](#)
- Did you push in the ink tank completely until you heard a clicking sound?
- If the orange tape is there, has it been peeled off completely?
Any remaining tape will hinder ink output.
- Did you install the ink tanks in their correct positions?

3. Load paper in the printer

Load one sheet of A4 size or Letter size plain paper into the rear tray.

4. Print a nozzle check pattern

Make sure that the printer is on and click **Print Check Pattern**.

Printing of the nozzle check pattern begins.

5. Check the print result

When the dialog opens, check the print result. If the print result is normal, click **Quit**.

If the print result is smudged or if there are any unprinted sections, click **Cleaning** to clean the print head.

Related Topic

- [Cleaning the Print Heads](#)

Checking the Ink Status from Your Computer

You can check the detailed information such as the remaining ink level and the ink tank types of your model.

Select **Ink Level Information** from the pop-up menu on the [Canon IJ Printer Utility2](#)

The status of the Ink Tank and Maintenance Cartridge are depicted using an illustration.

Estimated ink levels

You can check the types and levels of ink.

When ink levels are running low or an error occurs because there is no ink, a notification icon will appear.

If you place the cursor on the ink tank, it will display the ink model number and the ink levels.

Estimated Maintenance Cartridge Usage

You can check the estimated usage amount of the maintenance cartridge.

When capacity levels are low or the cartridge is at full capacity, a notification icon will appear.

▶▶▶ Note

- Click  to check which ink tank your model uses.
- Clicking **Update** will display the current status of ink tanks and the maintenance cartridge.
- When you print on A3 paper or larger paper sizes, the ink may run out before printing is finished or the printing may become faint or streaky (with white lines).

Maintenance Cartridge

- **Replacing the Maintenance Cartridge**
- **Checking the Maintenance Cartridge Status with the LCD on the Printer**

Replacing the Maintenance Cartridge

In case of cautions or errors concerning the maintenance cartridge, an error message will appear on the LCD to inform you of the error. Take appropriate action as prompted by the message.

■ [Message Appears](#)

▶▶▶ Important

- If the displayed message indicates that the maintenance cartridge is nearly full, promptly obtain a new one. If the maintenance cartridge becomes full, an error message is displayed and the printer stops working until it is replaced with a new one.

▶▶▶ Note

- When purchasing a new maintenance cartridge, order the following cartridge number.
Maintenance Cartridge MC-20

When you need to replace the maintenance cartridge, follow the procedure below.

1. Make sure that the power is turned on, then display the HOME screen.
If the HOME screen is not displayed, press the **HOME** button.

2. Select **Maintenance** on the HOME screen, then press the **OK** button.

■ [LCD and Operation Panel](#)

The **Maintenance** screen will appear.

3. Select **Maintenance cartridge info**, then press the **OK** button.

The **Maintenance cartridge info** screen will appear.

4. Press the **OK** button.

5. Open the maintenance cover.



6. Push up the lock lever (A) with your finger.

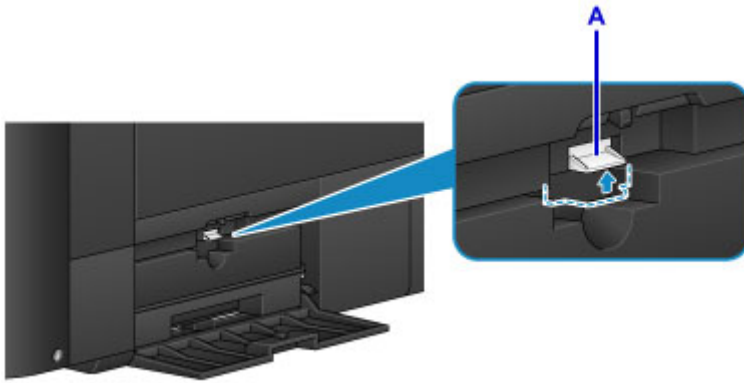

7. Remove the maintenance cartridge.

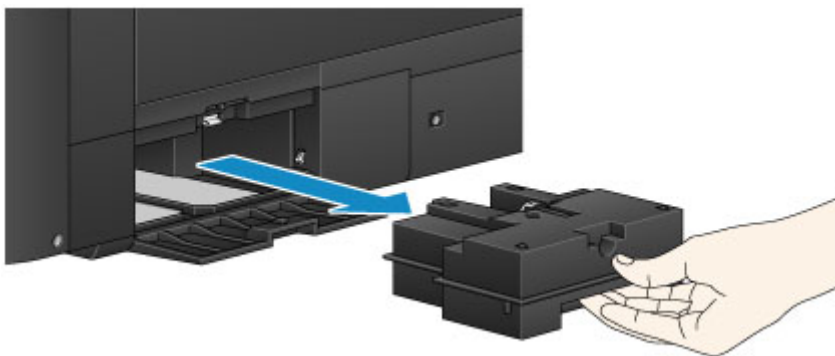

8. Insert the new maintenance cartridge straight into the slot.

Align the four corners of the maintenance cartridge with the slot as shown in the figure below.

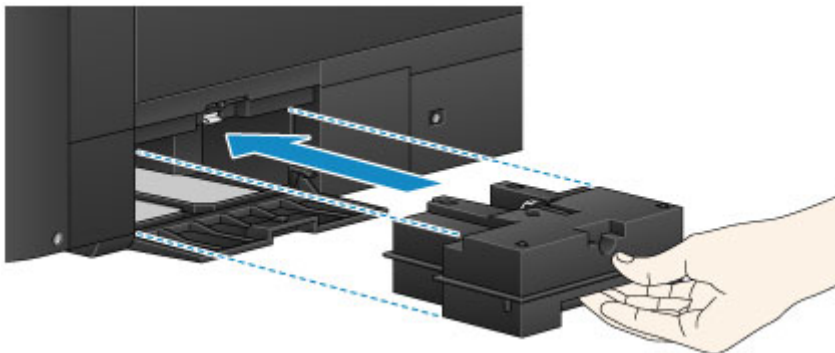

»» Important

- Do not touch the terminal (B) of the maintenance cartridge.

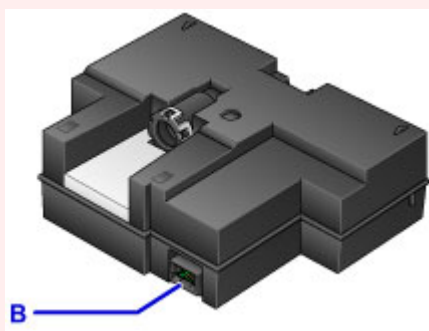

9. Push down the lock lever (A) to lock the maintenance cartridge.

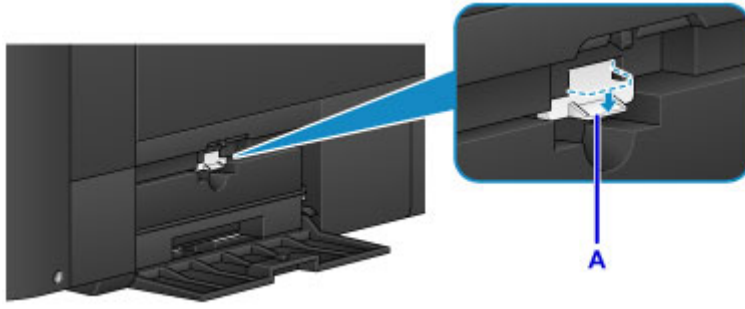

10. Close the maintenance cover.

Checking the Maintenance Cartridge Status with the LCD on the Printer

1. Make sure that the power is turned on, and display the HOME screen.

If the HOME screen is not displayed, press the **HOME** button.

2. Select **Maintenance** on the HOME screen, then press the **OK** button.

■ [LCD and Operation Panel](#)

The **Maintenance** screen will appear.

3. Select **Maintenance cartridge info**, then press the **OK** button.

4. Check the maintenance cartridge status.

A symbol appears in the area A if there is any information about the used space of the maintenance cartridge.

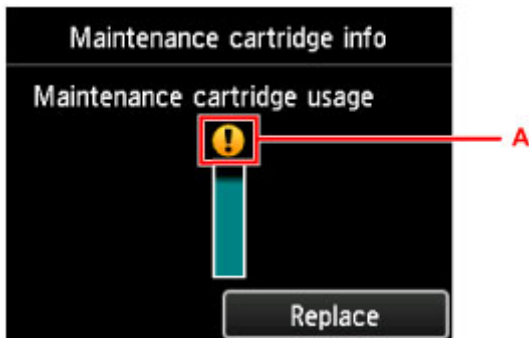

Example: ⚠

The maintenance cartridge is almost full. Prepare a new maintenance cartridge because an error may occur if you continue to use the printer while the maintenance cartridge is full.

▶▶▶ Note

- The above screen shows estimated used space.
- To replace the maintenance cartridge, select **Replace**.

■ [Replacing the Maintenance Cartridge](#)

Cleaning the Printer

- ▶ **Cleaning the Exterior of the Printer**
- ▶ **Cleaning the Paper Feed Roller**
- ▶ **Cleaning the Inside of the Printer (Bottom Plate Cleaning)**

Cleaning the Exterior of the Printer

Be sure to use a soft and dry cloth such as eyeglasses cleaning cloth and wipe off dirt on the surface gently. Smooth out wrinkles on the cloth if necessary before cleaning.

»» Important

- Be sure to turn off the power and unplug the power cord before cleaning the printer.
- Do not use tissue paper, paper towels, rough-textured cloth, or similar materials for cleaning so as not to scratch the surface. Paper tissue powder or fine threads may remain inside the printer and cause problems such as print head blockage and poor printing results.
- Never use volatile liquids such as thinners, benzene, acetone, or any other chemical cleaner to clean the printer, as this may cause a malfunction or damage the surface of the printer.

Cleaning the Paper Feed Roller

If the paper feed roller is dirty or paper powder is attached to it, paper may not be fed properly.

In this case, clean the paper feed roller. Cleaning will wear out the paper feed roller, so perform this only when necessary.

You need to prepare:

For the rear tray: three sheets of A4 or Letter size plain paper

For the manual feed tray: a single sheet of A4 or Letter size plain paper

1. Make sure that the power is turned on.
2. Select **Maintenance** on the HOME screen, then press the **OK** button.

■ [LCD and Operation Panel](#)

The **Maintenance** screen will appear.

3. Select **Roller cleaning**, then press the **OK** button.

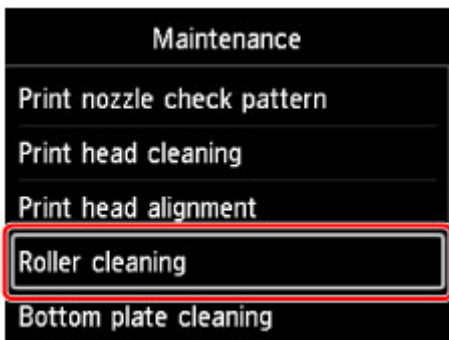

The confirmation screen will appear.

4. Select **Yes**, then press the **OK** button.
5. Select the paper source to clean (**Rear tray** or **Manual tray**), then press the **OK** button.

If **Manual tray** is selected, go to step 7.

6. If **Rear tray** is selected, remove any paper in the rear tray, then press the **OK** button.

The paper feed roller will rotate as it is cleaned without paper.

When the paper feed roller stops rotating, the cleaning is complete.

7. Follow the message to load A4 or Letter size plain paper in the paper source you selected in step 5.

Load three sheets of paper in the rear tray or a single sheet of paper in the manual feed tray.

8. Open the paper output tray gently.

Open the output tray extension, then pull out the paper output support.

9. Press the **OK** button.

The printer starts cleaning. The cleaning will be complete when the paper is ejected.

10. When the completion message appears, press the **OK** button.

If the problem is not resolved after cleaning the paper feed roller, turn off the power, unplug the power cord, then wipe the paper feed roller parts (the large paper feed roller in the center and four rollers on each side of it) (A) located in the rear tray with a moistened cotton swab or the like. Do not touch the paper feed roller (B) with your fingers. Wipe the paper feed roller parts with a cotton swab while turning the shaft (C) with your fingers.

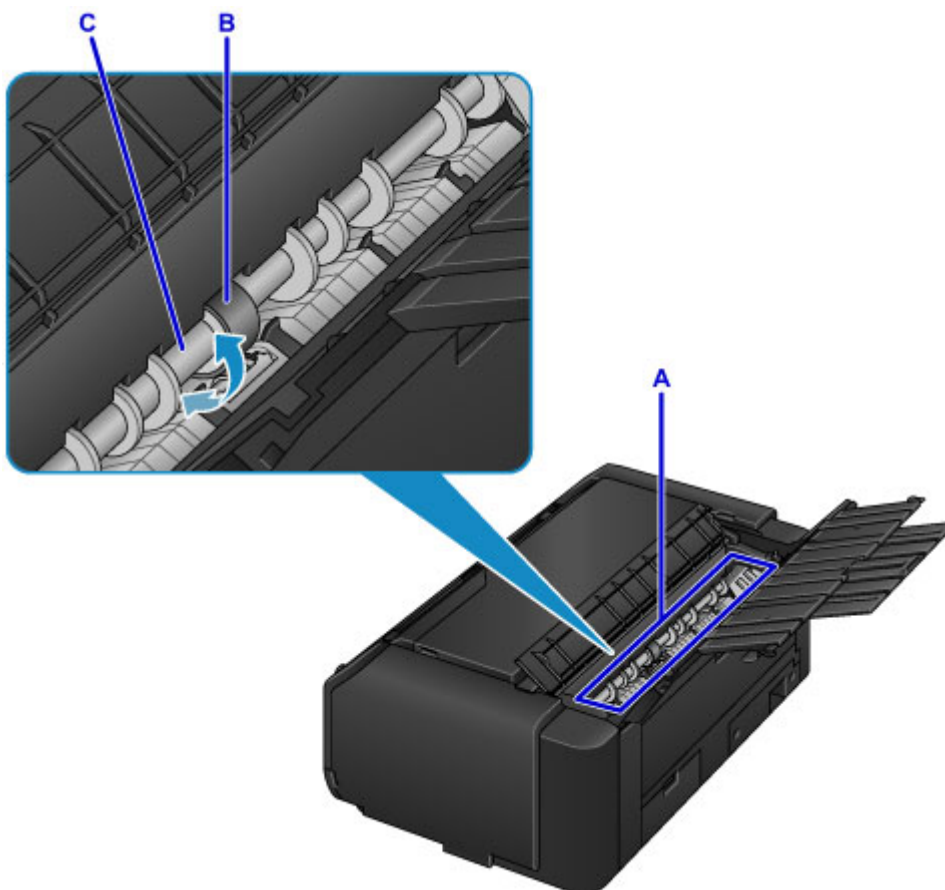

After cleaning the paper feed roller parts with a cotton swab, turn on the power, then clean the paper feed roller from the operation panel again.

If the problem is not resolved after cleaning the paper feed roller, contact the service center.

Cleaning the Inside of the Printer (Bottom Plate Cleaning)

Remove stains from the inside of the printer. If the inside of the printer becomes dirty, printed paper may get dirty, so we recommend performing cleaning regularly.

You need to prepare: a single sheet of A3 size plain paper*

* Be sure to use a new piece of paper.

1. Make sure that the power is turned on.
2. Select **Maintenance** on the HOME screen, then press the **OK** button.

■ [LCD and Operation Panel](#)

The **Maintenance** screen will appear.

3. Select **Bottom plate cleaning**, then press the **OK** button.

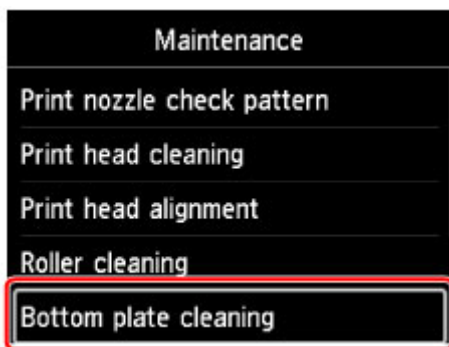

The confirmation screen will appear.

4. Select **Yes**, then press the **OK** button.
5. Follow the message to remove any paper from the rear tray, then press the **OK** button.
6. Fold a single sheet of A3 size plain paper in half lengthwise, unfold the paper, then press the **OK** button.
7. Load this sheet of paper sideways in the rear tray with the open side facing you.



8. Open the paper output tray gently.

Open the output tray extension, then pull out the paper output support.

9. Press the **OK** button.

The paper cleans the inside of the printer as it feeds through the printer.

Check the folded parts of the ejected paper. If they are smudged with ink, perform Bottom Plate Cleaning again.

10. When the completion message appears, press the **OK** button.

▶▶▶ Note

- When performing Bottom Plate Cleaning again, be sure to use a new piece of paper.

If the problem is not resolved after performing cleaning again, the protrusions inside the printer may be stained. Wipe off any ink from the protrusions using a cotton swab or the like.

▶▶▶ Important

- Be sure to turn off the power and unplug the power cord before cleaning the printer.

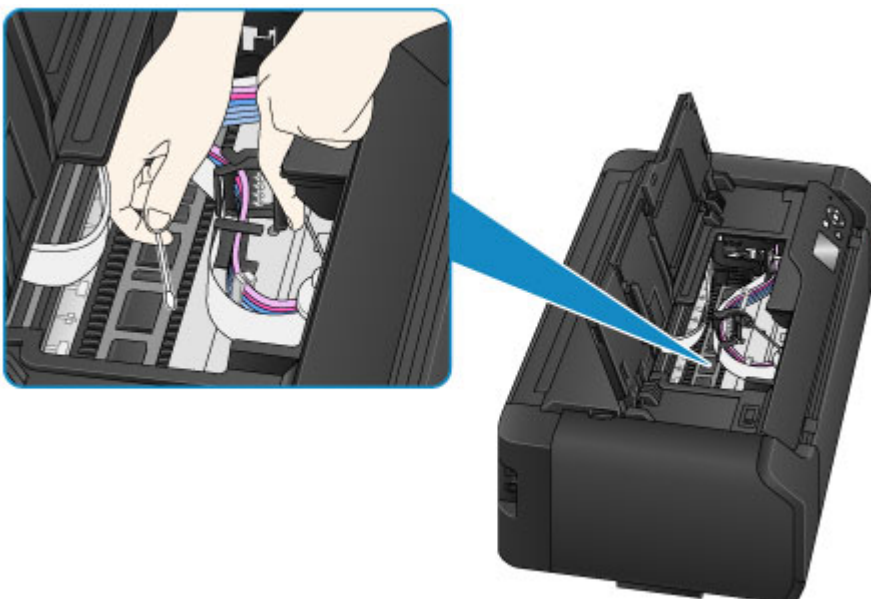

Other Maintenance

- ▶ [Relocating Your Printer](#)
- ▶ [Transporting Your Printer](#)

Relocating Your Printer



Observe the following precautions when moving the printer in its horizontal orientation from its place of installation.

»» Important

- Do not tilt the printer or turn it on its side or upside down. Doing so may cause ink to leak during relocation.
- When moving the printer, always carry it with two people.
- Do not remove the ink tank and the maintenance cartridge from the printer. To turn off the power, press the **ON** button. This allows the printer to automatically cap the print head, thus preventing it from drying.
- Reinstall the printer on a flat place while paying attention to the [ink supply stopper](#).

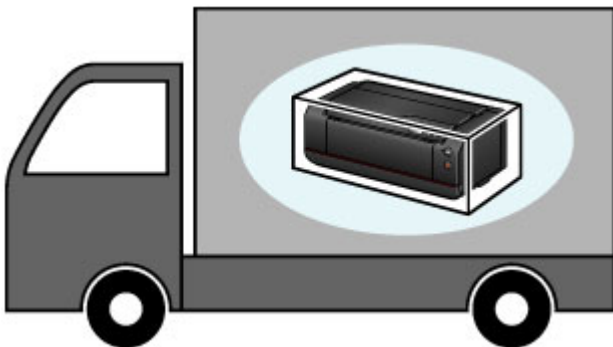

If transporting your printer, see [Transporting Your Printer](#).

Transporting Your Printer

Do not tilt the printer or turn it on its side or upside down. Doing so may cause ink to leak during relocation.

If you can transport the printer in its horizontal orientation:

- [Packing the printer](#)

If the printer may tilt during transport:

▶▶▶ Important

- If you tilt the printer or turn it on its side or upside down, ink may leak.

For this reason, when transporting the printer, to prevent the ink leakage, the ink in the printer and a certain amount of ink in the ink tanks need to be ejected into the maintenance cartridge.

If the maintenance cartridge does not have the remaining capacity enough for ejected ink, you need to replace it with a new one. Up to three maintenance cartridges are required.

If replacement of the maintenance cartridge is not possible, printer transport preparation cannot be executed. We recommend you to prepare maintenance cartridges before executing printer transport preparation.

However, the maintenance cartridge removed for printer transport preparation may still have the remaining capacity for printing.

In such cases, the removed maintenance cartridge can be reinstalled for use.

When you first use the printer after executing printer transport preparation, a certain amount of ink is consumed to set up the printer for printing. The maintenance cartridge is also consumed for this set up.

Prepare to transport the printer and remove ink tanks.

1. [Preparing to Transport Your printer](#)
2. [Packing Your printer](#)
3. [Reinstalling Your printer](#)

Preparing to Transport Your printer

1. Make sure that the power is turned on.
2. Select **Maintenance** on the HOME screen, then press the **OK** button.

- [LCD and Operation Panel](#)

The **Maintenance** screen will appear.

3. Select **Prepare to transportation**, then press the **OK** button.

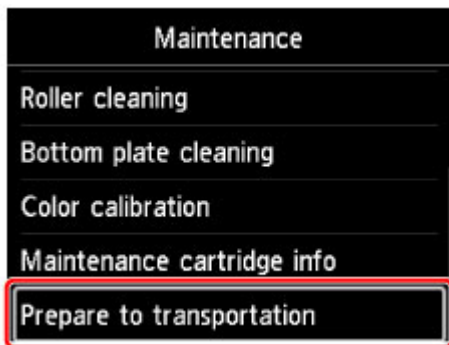

The confirmation screen will appear.

4. Check the message, select **Yes**, then press the **OK** button.

The ink in the printer is ejected into the maintenance cartridge. This takes about 5 minutes to complete (excluding the maintenance cartridge replacement).

Do not perform any other operations during this operation.

►►► Important

- If the space in the maintenance cartridge is almost used up, a message prompting you to replace the maintenance cartridge is displayed. Follow the directions in the message to [replace the maintenance cartridge](#).
- If the maintenance cartridge becomes full, a message prompting you to replace it will be displayed. Follow the directions in the message to [replace the maintenance cartridge](#).
- Do not unplug the printer while the **POWER** lamp is lit or flashing. This may cause malfunction or damage to the printer, preventing it from printing.

5. If a message prompting you to replace an ink tank appears, remove all ink tanks.

■ [Replacing Ink](#)

6. Close the tank cover.

A message prompting you to replace the maintenance cartridge will be displayed. Follow the directions in the message to [replace the maintenance cartridge](#).

The ink in the printer is ejected into the maintenance cartridge. This takes about 6 minutes to complete (excluding the maintenance cartridge replacement).

Do not perform any other operations during this operation.

When the completion message appears, turn off the printer.

►►► Important

- Keep removed ink tanks in a bag to avoid staining of clothing or the surrounding area. Also, do not drop ink tanks or apply excessive pressure to them. Handle carefully.

Packing Your printer

1. Turn off the printer.
2. Confirm that the **POWER** lamp is off and [unplug the power cord](#).

»» Important

- Do not unplug the printer while the **POWER** lamp is lit or flashing, as it may cause malfunction or damage to the printer, making the printer unable to print.

3. Retract the paper output support, then close the output tray extension and the paper output tray.
4. Close the rear tray or the manual feed tray.
To close the rear tray, retract the paper support extension, then close the paper support.
To close the manual feed tray, retract the paper support extension and the paper support.
5. Unplug the printer cable from the computer and from the printer, then unplug the power cord from the printer.
6. Use adhesive tape to secure all the covers on the printer to keep them from opening during relocation.
7. Attach the protective material to the printer when packing the printer in the box.

»» Important

- Reinstall the printer on a flat place while paying attention to the [ink supply stopper](#).

Reinstalling Your printer

When the preparations to transport have been done and the printer was transferred, follow the procedure below.

»» Important

- During reinstallation, a great amount of ink is consumed since ink is loaded into the printer or inside of print head. Additional new ink tanks or maintenance cartridges may be also necessary since a great amount of ink is ejected. Obtain ink tanks or maintenance cartridges before performing preparations.

1. Take the printer out of the box.
2. Press the **ON** button to turn on the printer.
3. Check the message, select **Yes**, then press the **OK** button.
4. When the message appears, open the tank cover, then install all removed ink tanks.

■ [Replacing Ink](#)

After the tank cover is closed, the printer starts preparations to reinstall it. Wait for a while.

Do not perform any other operations during this operation.

The main menu will appear after preparations to reinstall the printer are complete.

Important

- If the remaining ink level is low, a message prompting you to replace ink tanks is displayed. Follow the directions in the message to [replace the ink tank](#) and then press the **Back** button.

We recommend storing the removed ink tanks since they may still be usable for normal printing.

- If the space in the maintenance cartridge is almost used up, a message prompting you to replace the maintenance cartridge is displayed. Follow the directions in the message to [replace the maintenance cartridge](#) and then press the **Back** button.

We recommend storing the removed maintenance cartridge since it may still be usable for normal printing.

- Keep removed ink tanks in a bag to avoid staining of clothing or the surrounding area. Also, do not drop ink tanks or apply excessive pressure to them. Handle carefully.
- Do not turn off the printer or unplug the printer during preparations to reinstall it. Doing so may cause a malfunction or damage to the printer, preventing it from printing.

Specifications

- ▶ **Specifications**

- ▶ **Printing Area**

- Printing Area
- Other Sizes than Letter or Legal
- Letter, Legal
- Sizes for 0.98 inch (25 mm) Margin Paper

Specifications

»» Important

- The following values may vary depending on the operating environment.

General Specifications

Power supply	100-240 V AC (50/60 Hz)
Power consumption	<p>Printing: 37 W max.</p> <p>Standby (minimum): 2.5 W max. *1</p> <p>OFF: 0.4 W max. *2</p> <p>*1 The wait time for standby cannot be changed.</p> <p>*2 The printer uses a trace amount of power even when turned off. To stop all power consumption, turn off the printer and unplug the power cord.</p>
Operating environment	<p>Temperature: 41 to 95 °F (5 to 35 °C)</p> <p>Humidity: 10 to 90 % RH (no condensation)</p> <p>* The performance of the printer may be reduced under certain temperature and humidity conditions.</p> <p>Recommended conditions:</p> <p>Temperature: 59 to 86 °F (15 to 30 °C)</p> <p>Humidity: 10 to 80 % RH (no condensation)</p> <p>* For the temperature and humidity conditions of papers such as photo paper, refer to the paper's packaging or the supplied instructions.</p>
Storage environment	<p>Temperature: 32 to 104 °F (0 to 40 °C)</p> <p>Humidity: 5 to 95 % RH (no condensation)</p>
Dimensions (W x D x H)	<p>28.5 x 17.2 x 11.3 inches (723 x 435 x 285 mm)</p> <p>* With the trays retracted.</p>
Weight	<p>Approx. 71.1 lb (Approx. 32.3 kg)</p> <p>* With the Print Head and ink tanks installed.</p>
Printing resolution (dpi)	<p>2400 dpi horizontally * x 1200 dpi vertically</p> <p>* Prints with a minimum 1/2400 inch dot pitch between ink droplets.</p>
Print Head/Ink	Total 18432 nozzles (MBK / PBK / C / M / Y / PC / PM / GY / PGY / R / B / CO each 1536 nozzles)
Memory	1 GB

Network Specifications

Communication protocol	TCP/IP
Wired LAN	<p>Supported Standards: IEEE802.3u (100BASE-TX) / IEEE802.3 (10BASE-T)</p> <p>Transfer speed: 10 M/100 Mbps (auto switching)</p>
Wireless LAN	Supported Standards: IEEE802.11n / IEEE802.11g / IEEE802.11b

	<p>Frequency bandwidth: 2.4 GHz</p> <p>Channel: 1-11 or 1-13</p> <p>* Frequency bandwidth and available channels differ depending on country or region.</p> <p>Communication distance: Indoors 164 feet/50 m</p> <p>* Effective range varies depending on the installation environment and location.</p> <p>Security:</p> <p>WEP (64/128 bits)</p> <p>WPA-PSK (TKIP/AES)</p> <p>WPA2-PSK (TKIP/AES)</p> <p>Setup:</p> <p>WPS (Push button configuration/PIN code method)</p> <p>WCN (WCN-NET)</p> <p>Cableless setup</p> <p>Other Features: Administration password</p>
--	---

Paper

For information on the types of paper the printer supports, see [Media Types You Can Use](#).

Paper width	<p>Rear tray: From 3.5 to 17.0 inches (89 to 432 mm)</p> <p>Manual feed tray: From 8.0 to 17.0 inches (203.2 to 432 mm)</p>
Minimum paper length	<p>Rear tray: 5.0 inches (127 mm)</p> <p>Manual feed tray: 10.0 inches (254 mm)</p>
Maximum printable length	23.4 inches (594 mm)
Thickness	<p>Rear tray:</p> <p>Plain paper: From 17 to 28 lb (64 to 105 g /m²)</p> <p>Specialty paper: Up to 80 lb (300 g /m²) / from 4 to 11.8 mil (0.1 to 0.3 mm)</p> <p>Manual feed tray:</p> <p>Specialty paper: Up to 107 lb (400 g /m²) / from 4 to 27.6 mil (0.1 to 0.7 mm)</p>
Print area	For details, see Printing Area .

Minimum System Requirements

Conform to the operating system's requirements when higher than those given here.

Windows

Operating System	<p>Windows 8.1*, Windows 8</p> <p>Windows 7, Windows 7 SP1</p> <p>Windows Vista SP2</p> <p>* Windows 8.1 includes Windows 8.1 Update.</p> <p>Printer driver, Quick Utility Toolbox and IJ Network Device Setup Utility support the following OS:</p>
-------------------------	--

	Windows Server 2008, Windows Server 2008 R2, Windows Server 2012 and Windows Server 2012 R2.
Hard Disk Space	3.1 GB Note: For bundled software installation. The necessary amount of hard disk space may be changed without notice.
Display	XGA 1024 x 768

Mac OS

Operating System	OS X v10.7.5 - OS X v10.10
Hard Disk Space	1.5 GB Note: For bundled software installation. The necessary amount of hard disk space may be changed without notice.
Display	XGA 1024 x 768

Other Supported OS

Some functions may not be available with each OS. Refer to the Canon web site for details on operation with iOS and Android.

Mobile Printing Capability

Apple AirPrint
Google Cloud Print
PIXMA Cloud Link

- An internet connection is required to use all the *Online Manual*.
- Windows: Operation can only be guaranteed on a computer with Windows 8.1, Windows 8, Windows 7 or Windows Vista pre-installed.
- Windows: A CD-ROM Drive or internet connection is required during software installation.
- Windows: Internet Explorer 8, 9, 10 or 11 is required to install Easy-WebPrint EX.
- Windows: Some functions may not be available with Windows Media Center.
- Windows: .NET Framework 4 or 4.5 must be installed to use the Windows software.
- Mac OS: For Mac OS, an internet connection is required during software installation.
- In an in-house network environment, the 5222 port must be open. Contact the network administrator for details.

Information in this guide is subject to change without notice.

Printing Area

- ▶ **Printing Area**
- ▶ **Other Sizes than Letter or Legal**
- ▶ **Letter, Legal**
- ▶ **Sizes for 0.98 inch (25 mm) Margin Paper**

Printing Area

To ensure the best print quality, the printer allows a margin along each edge of media. The actual printable area will be the area inside these margins.

Recommended printing area  : Canon recommends that you print within this area.

Printable area  : The area where it is possible to print. However, printing in this area can affect the print quality or the paper feed precision.

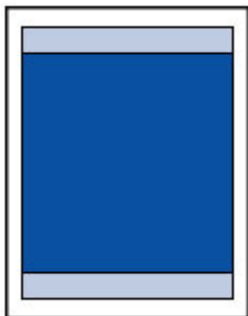

▶▶ Note

- To specify the amount of image that extends off the paper, select **Extension for borderless printing** in **Advanced paper settings**.

- [Paper-related settings](#)

- By selecting Borderless Printing option, you can make prints with no margins.
- When performing Borderless Printing, slight cropping may occur at the edges since the printed image is enlarged to fill the whole page.
- For Borderless Printing, use the following paper:
 - Photo Paper Pro Platinum <PT-101>
 - Photo Paper Plus Glossy II <PP-201>
 - Photo Paper Pro Luster <LU-101>
 - Photo Paper Plus Semi-gloss <SG-201>
 - Matte Photo Paper <MP-101>[*1](#)
 - Photo Paper Pro Premium Matte <PM-101>[*1](#)

*1 Borderless Printing is disabled depending on print settings. To enable Borderless Printing, remove margin restrictions.

- Print Options dialog box (Windows)

- [Paper Detailed Settings](#) (Mac OS)

Performing Borderless Printing on any other type of paper may substantially reduce printing quality and/or result in printouts with altered color hues.

- Borderless Printing is not available for A5, B5, B4, B3, Legal, or 11" x 17" (28 x 43 cm) size paper or plain paper.
- Depending on the type of paper, Borderless Printing may reduce the print quality at the top and bottom edges of the paper. Borderless Printing on thick paper may also smudge the front or back surface of the paper.

Other Sizes than Letter or Legal

Size	Printable Area (width x height)
A5	5.56 x 7.95 inches (141.2 x 202.0 mm)
A4	8.00 x 11.38 inches (203.2 x 289.0 mm)
A3	11.43 x 16.22 inches (290.2 x 412.0 mm)
A3+	12.69 x 18.70 inches (322.2 x 475.0 mm)
A2	16.27 x 23.07 inches (413.2 x 586.0 mm)
B5	6.90 x 9.80 inches (175.2 x 249.0 mm)
B4	9.85 x 14.02 inches (250.2 x 356.0 mm)
B3	14.06 x 19.96 inches (357.2 x 507.0 mm)
4" x 6" (10 x 15 cm)	3.73 x 5.69 inches (94.8 x 144.4 mm)
5" x 7" (13 x 18 cm)	4.73 x 6.69 inches (120.2 x 169.8 mm)
8" x 10" (20 x 25 cm)	7.73 x 9.69 inches (196.4 x 246.0 mm)
10" x 12" (25 x 30 cm)	9.73 x 11.69 inches (247.2 x 296.8 mm)
11" x 17" (28 x 43 cm)	10.73 x 16.69 inches (272.6 x 423.8 mm)
14" x 17" (36 x 43 cm)	13.73 x 16.69 inches (348.8 x 423.8 mm)
17" x 22" (43 x 56 cm)	16.73 x 21.69 inches (425.0 x 550.8 mm)

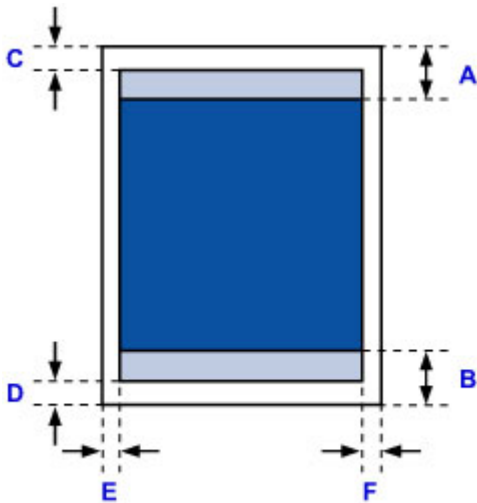

 Recommended printing area

A: 2.22 inches (56.3 mm)

B: 2.15 inches (54.5 mm)

 Printable area

C: 0.12 inch (3.0 mm)

D: 0.20 inch (5.0 mm)

E: 0.13 inch (3.4 mm)

F: 0.13 inch (3.4 mm)

Letter, Legal

Size	Printable Area (width x height)
Letter	8.00 x 10.69 inches (203.2 x 271.4 mm)
Legal	8.00 x 13.69 inches (203.2 x 347.6 mm)

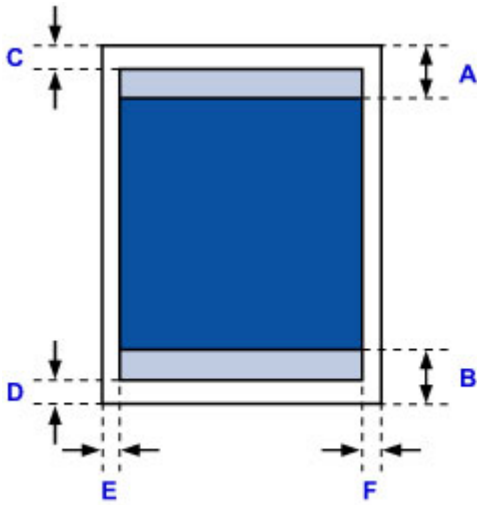

 Recommended printing area

A: 2.22 inches (56.3 mm)

B: 2.15 inches (54.5 mm)

 Printable area

C: 0.12 inch (3.0 mm)

D: 0.20 inch (5.0 mm)

E: 0.25 inch (6.4 mm)

F: 0.25 inch (6.3 mm)

Sizes for 0.98 inch (25 mm) Margin Paper

When art paper with 0.98 inch (25 mm) margins is selected, the printer is restricted from printing in the top and bottom 0.98 inch (25 mm) of the paper. We therefore recommend checking the printing area in the preview screen before printing.

If the print head is rubbing against the top of bottom edges of the paper, causing smudging, you can avoid this by using 0.98 inch (25 mm) margin paper.

Photo Paper Pro Premium Matte PM-101 and Matte Photo Paper MP-101 are printed to paper sizes with 0.98 inch (25 mm) margins depending on print settings. To print to other page sizes, remove restrictions on margins.

- Print Options dialog box (Windows)
- [Paper Detailed Settings](#) (Mac OS)

A4/A3/A3+/A2/17" x 22" (43 x 56 cm)

Size	Recommended Printing Area (width x height)
A4 (0.98 inch (25 mm) margin)	8.00 x 9.72 inches (203.2 x 247.0 mm)
A3 (0.98 inch (25 mm) margin)	11.43 x 14.57 inches (290.2 x 370.0 mm)
A3+ (0.98 inch (25 mm) margin)	12.69 x 17.05 inches (322.2 x 433.0 mm)
A2 (0.98 inch (25 mm) margin)	16.27 x 21.42 inches (413.2 x 544.0 mm)
17" x 22" (43 x 56 cm) (0.98 inch (25 mm) margin)	16.73 x 20.03 inches (425.0 x 508.8 mm)

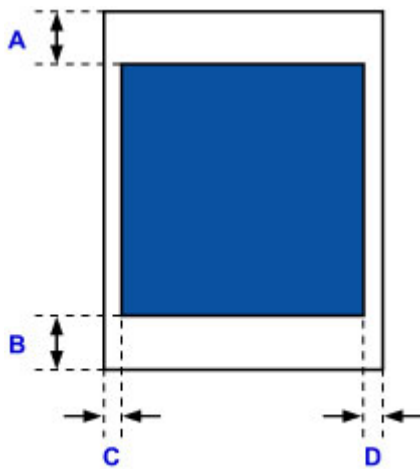



■ Recommended printing area

- A: 0.98 inch (25.0 mm)
- B: 0.98 inch (25.0 mm)
- C: 0.13 inch (3.4 mm)
- D: 0.13 inch (3.4 mm)

Letter

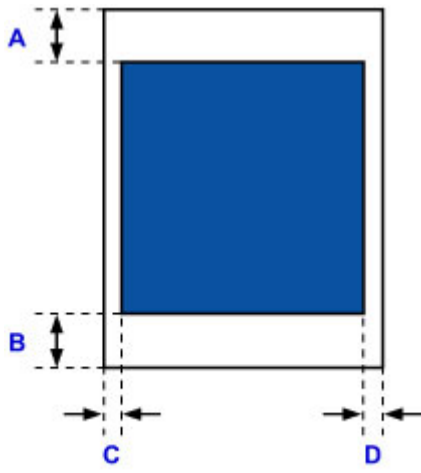
Size	Recommended Printing Area (width x height)
Letter (0.98 inch (25 mm) margin)	8.00 x 9.03 inches (203.2 x 229.4 mm)



 Recommended printing area

A: 0.98 inch (25.0 mm)

B: 0.98 inch (25.0 mm)

C: 0.25 inch (6.4 mm)

D: 0.25 inch (6.3 mm)

Appendix

▶ **Safety**

- Safety Precautions
- Regulatory Information

▶ **Legal Restrictions on Printing**

Safety

- ▶ **Safety Precautions**
- ▶ **Regulatory Information**

Safety Precautions

Choosing a location

- Never install the printer on an unstable or vibrating surface.
- Do not install the printer in locations that are very humid or dusty, in direct sunlight, outdoors, or close to a heating source.
To avoid the risk of fire or electric shocks, use the printer under the operating environment specified in the Specification.
- Do not place the printer on a thick rug or carpet.
- Do not place the printer with its back attached to the wall.
- We recommend ensuring ample space for installation.
- Do not install the printer near sources of strong electromagnetic fields, whether equipment that generates such fields or places where such fields occur.

Power supply

- Ensure that the area around the power outlet is kept clear at all times so you can easily unplug the power cord if necessary.
- Never remove the plug by pulling on the cord.
Pulling the cord may damage the power cord, leading to possible fire or electrical shock.
- Do not use an extension lead/cord.

Working around the printer

- Never put your hands or fingers in the printer while it is printing.
- When moving the printer, always carry it with two people. And carry the printer at both ends.
Accidental dropping of the printer causes injury.
- Do not place any object on the printer. Especially do not place metal objects (paper clips, staples, etc.) or containers of flammable solvents (alcohol, thinners, etc.) on top of the printer.
- Do not transport or use the printer on a slant, vertically or upside-down, as the ink may leak and damage the printer.

Print Heads/ink tanks/FINE Cartridges and maintenance cartridges

- Keep ink tanks out of the reach of children. In case ink* is accidentally licked or swallowed, rinse out mouth or give one or two glasses of water to drink. If irritation or discomfort occurs, obtain medical advice immediately.
* Clear Ink contains nitrate salts (For models containing Clear Ink).
- In case ink gets in contact with eyes, rinse with water immediately. In case ink gets in contact with skin, wash with soap and water immediately. If irritation to eyes or skin persists, obtain medical advice immediately.
- Never touch the electrical contacts on a Print Head or FINE Cartridges after printing.
The metal parts may be very hot and could cause burns.
- Do not throw ink tanks and FINE Cartridges into fire.
- Do not attempt to disassemble or modify the Print Head, ink tanks, and FINE Cartridges.
- Avoid dropping or shaking Print Head, ink tanks, and maintenance cartridges.

Regulatory Information

For models containing lithium battery

- Dispose of used batteries according to the local regulations.
- Risk of explosion if battery is replaced by an incorrect type.

Users in the U.S.A.

FCC Notice (U.S.A. Only)

For 120V, 60Hz model

Model Number: K10424 (Contains FCC Approved WLAN Module K30357)

This device complies with Part 15 of the FCC Rules. Operation is subject to the following two conditions: (1) This device may not cause harmful interference, and (2) this device must accept any interference received, including interference that may cause undesired operation.

Note: This equipment has been tested and found to comply with the limits for a Class B digital device, pursuant to Part 15 of the FCC Rules. These limits are designed to provide reasonable protection against harmful interference in a residential installation. This equipment generates, uses and can radiate radio frequency energy and, if not installed and used in accordance with the instructions, may cause harmful interference to radio communications.

However, there is no guarantee that interference will not occur in a particular installation. If this equipment does cause harmful interference to radio or television reception, which can be determined by turning the equipment off and on, the user is encouraged to try to correct the interference by one or more of the following measures:

- Reorient or relocate the receiving antenna.
- Increase the separation between the equipment and receiver.
- Connect the equipment into an outlet on a circuit different from that to which the receiver is connected.
- Consult the dealer or an experienced radio/TV technician for help.

Use of a shielded cable is required to comply with Class B limits in Subpart B of Part 15 of the FCC Rules.

Do not make any changes or modifications to the equipment unless otherwise specified in the manual. If such changes or modifications should be made, you could be required to stop operation of the equipment.

FCC ID:AZDK30357

Changes or modifications not expressly approved by the party responsible for compliance could void the user's authority to operate equipment.

This transmitter must not be co-located or operating in conjunction with any other antenna or transmitter.

The equipment complies with FCC radiation exposure limits for uncontrolled equipment. This equipment should be installed and operated with minimum distance at least 20cm between the radiator and persons body (excluding extremities: hands, wrists, feet and ankles) and must not be colocated or operated with any other antenna or transmitter.

Canon U.S.A., Inc.

One Canon Park

Melville, New York 11747

1-800-652-2666

Users in Canada

This device complies with Industry Canada license-exempt RSS standard(s). Operation is subject to the following two conditions:

(1) this device may not cause interference, and (2) this device must accept any interference, including interference that may cause undesired operation of the device.

This equipment complies with IC radiation exposure limits set forth for an uncontrolled environment and meets RSS-102 of the IC radio frequency (RF) Exposure rules. This equipment should be installed and operated keeping the radiator at least 20cm or more away from person's body (excluding extremities: hands, wrists, feet and ankles).

Pour les usagers résidant au Canada

Le présent appareil est conforme aux CNR d'Industrie Canada applicables aux appareils radio exempts de licence. L'exploitation est autorisée aux deux conditions suivantes :

(1) l'appareil ne doit pas produire de brouillage, et (2) l'utilisateur de l'appareil doit accepter tout brouillage radioélectrique subi, même si le brouillage est susceptible d'en compromettre le fonctionnement.

Cet équipement est conforme aux limites d'exposition aux rayonnements énoncées pour un environnement non contrôlé et respecte les règles d'exposition aux fréquences radioélectriques (RF) CNR-102 de l'IC. Cet équipement doit être installé et utilisé en gardant une distance de 20 cm ou plus entre le dispositif rayonnant et le corps (à l'exception des extrémités : mains, poignets, pieds et chevilles).

Only for European Union and EEA (Norway, Iceland and Liechtenstein)

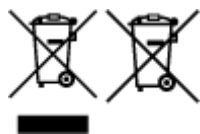

These symbols indicate that this product is not to be disposed of with your household waste, according to the WEEE Directive (2012/19/EU), the Battery Directive (2006/66/EC) and/or national legislation implementing those Directives. If a chemical symbol is printed beneath the symbol shown above, in accordance with the Battery Directive, this indicates that a heavy metal (Hg = Mercury, Cd = Cadmium, Pb = Lead) is present in this battery or accumulator at a concentration above an applicable threshold specified in the Battery Directive. This product should be handed over to a designated collection point, e.g., on an authorized one-for-one basis when you buy a new similar product or to an authorized collection site for recycling waste electrical and electronic equipment (EEE) and batteries and accumulators. Improper handling of this type of waste could have a possible impact on the environment and human health due to potentially hazardous substances that are generally associated with EEE. Your cooperation in the correct disposal of this product will contribute to the effective usage of natural resources. For more information about the recycling of this product, please contact your local city office, waste authority, approved scheme or your household waste disposal service or visit www.canon-europe.com/weee, or www.canon-europe.com/battery.

Nur für Europäische Union und EWR (Norwegen, Island und Liechtenstein)

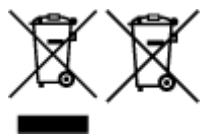

Diese Symbole weisen darauf hin, dass dieses Produkt gemäß WEEE-Richtlinie (2012/19/EU; Richtlinie über Elektro- und Elektronik-Altgeräte), Batterien-Richtlinie (2006/66/EG) und nationalen Gesetzen zur

Umsetzung dieser Richtlinien nicht über den Hausmüll entsorgt werden darf. Falls sich unter dem oben abgebildeten Symbol ein chemisches Symbol befindet, bedeutet dies gemäß der Batterien-Richtlinie, dass in dieser Batterie oder diesem Akkumulator ein Schwermetall (Hg = Quecksilber, Cd = Cadmium, Pb = Blei) in einer Konzentration vorhanden ist, die über einem in der Batterien-Richtlinie angegebenen Grenzwert liegt. Dieses Produkt muss bei einer dafür vorgesehenen Sammelstelle abgegeben werden. Dies kann z. B. durch Rückgabe beim Kauf eines neuen ähnlichen Produkts oder durch Abgabe bei einer autorisierten Sammelstelle für die Wiederaufbereitung von Elektro- und Elektronik-Altgeräten sowie Batterien und Akkumulatoren geschehen. Der unsachgemäße Umgang mit Altgeräten kann aufgrund potenziell gefährlicher Stoffe, die generell mit Elektro- und Elektronik-Altgeräten in Verbindung stehen, negative Auswirkungen auf die Umwelt und die menschliche Gesundheit haben. Durch Ihre Mitarbeit bei der umweltgerechten Entsorgung dieses Produkts tragen Sie zu einer effektiven Nutzung natürlicher Ressourcen bei. Um weitere Informationen über die Wiederverwertung dieses Produkts zu erhalten, wenden Sie sich an Ihre Stadtverwaltung, den öffentlich-rechtlichen Entsorgungsträger, eine autorisierte Stelle für die Entsorgung von Elektro- und Elektronik-Altgeräten oder Ihr örtliches Entsorgungsunternehmen oder besuchen Sie www.canon-europe.com/weee, oder www.canon-europe.com/battery.

Union Européenne, Norvège, Islande et Liechtenstein uniquement.



Ces symboles indiquent que ce produit ne doit pas être mis au rebut avec les ordures ménagères, comme le spécifient la Directive européenne DEEE (2012/19/UE), la Directive européenne relative à l'élimination des piles et des accumulateurs usagés (2006/66/CE) et les lois en vigueur dans votre pays appliquant ces directives. Si un symbole de toxicité chimique est imprimé sous le symbole illustré ci-dessus conformément à la Directive relative aux piles et aux accumulateurs, il indique la présence d'un métal lourd (Hg = mercure, Cd = cadmium, Pb = plomb) dans la pile ou l'accumulateur à une concentration supérieure au seuil applicable spécifié par la Directive. Ce produit doit être confié au distributeur à chaque fois que vous achetez un produit neuf similaire, ou à un point de collecte mis en place par les collectivités locales pour le recyclage des Déchets des Équipements Électriques et Électroniques (DEEE). Le traitement inapproprié de ce type de déchet risque d'avoir des répercussions sur l'environnement et la santé humaine, du fait de la présence de substances potentiellement dangereuses généralement associées aux équipements électriques et électroniques. Votre entière coopération dans le cadre de la mise au rebut correcte de ce produit favorisera une meilleure utilisation des ressources naturelles. Pour plus d'informations sur le recyclage de ce produit, contactez vos services municipaux, votre éco-organisme ou les autorités locales compétentes, ou consultez le site www.canon-europe.com/weee, ou www.canon-europe.com/battery.

Uitsluitend bestemd voor de Europese Unie en EER (Noorwegen, IJsland en Liechtenstein)



Met deze symbolen wordt aangegeven dat dit product in overeenstemming met de AEEA-richtlijn (2012/19/EU), de richtlijn 2006/66/EG betreffende batterijen en accu's en/of de plaatselijk geldende wetgeving waarin deze richtlijnen zijn geïmplementeerd, niet bij het normale huisvuil mag worden weggegooid. Indien onder het hierboven getoonde symbool een chemisch symbool gedrukt staat, geeft dit in overeenstemming met de richtlijn betreffende batterijen en accu's aan dat deze batterij of accu een zwaar metaal bevat (Hg = kwik, Cd = cadmium, Pb = lood) waarvan de concentratie de toepasselijke

drempelwaarde in overeenstemming met de genoemde richtlijn overschrijdt. Dit product dient te worden ingeleverd bij een hiervoor aangewezen inzamelpunt, bijv. door dit in te leveren bij een hiertoe erkend verkooppunt bij aankoop van een gelijksoortig product, of bij een officiële inzameldienst voor de recycling van elektrische en elektronische apparatuur (EEA) en batterijen en accu's. Door de potentieel gevaarlijke stoffen die gewoonlijk gepaard gaan met EEA, kan onjuiste verwerking van dit type afval mogelijk nadelige gevolgen hebben voor het milieu en de menselijke gezondheid. Uw medewerking bij het op juiste wijze weggooien van dit product draagt bij tot effectief gebruik van natuurlijke hulpbronnen. Voor verdere informatie over recycling van dit product kunt u contact opnemen met uw plaatselijke gemeente, afvaldienst, officiële dienst voor klein chemisch afval of afvalstortplaats, of kunt u terecht op www.canon-europe.com/weee, of www.canon-europe.com/battery.

Sólo para la Unión Europea y el Área Económica Europea (Noruega, Islandia y Liechtenstein)



Estos iconos indican que este producto no debe desecharse con los residuos domésticos de acuerdo con la Directiva sobre RAEE (2012/19/UE) y la Directiva sobre Pilas y Acumuladores (2006/66/CE) y/o la legislación nacional. Si aparece un símbolo químico bajo este icono, de acuerdo con la Directiva sobre Pilas y Acumuladores, significa que la pila o el acumulador contiene metales pesados (Hg = Mercurio, Cd = Cadmio, Pb = Plomo) en una concentración superior al límite especificado en dicha directiva. Este producto deberá entregarse en un punto de recogida designado, por ejemplo, entregándolo en el lugar de venta al adquirir un producto nuevo similar o en un centro autorizado para la recogida de residuos de aparatos eléctricos y electrónicos (RAEE), baterías y acumuladores. La gestión incorrecta de este tipo de residuos puede afectar al medio ambiente y a la salud humana debido a las sustancias potencialmente nocivas que suelen contener estos aparatos. Su cooperación en la correcta eliminación de este producto contribuirá al correcto aprovechamiento de los recursos naturales. Los usuarios tienen derecho a devolver pilas, acumuladores o baterías usados sin coste alguno. El precio de venta de pilas, acumuladores y baterías incluye el coste de la gestión medioambiental de su desecho, y no es necesario mostrar la cuantía de dicho coste en la información y la factura suministradas a los usuarios finales. Si desea más información sobre el reciclado de este producto, póngase en contacto con su municipio, el servicio o el organismo encargado de la gestión de residuos domésticos o visite www.canon-europe.com/weee, o www.canon-europe.com/battery.

Només per a la Unió Europea i a l'Espai Econòmic Europeu (Noruega, Islàndia i Liechtenstein)



Aquests símbols indiquen que aquest producte no s'ha de llençar amb les escombraries de la llar, d'acord amb la RAEE (2012/19/UE), la Directiva relativa a piles i acumuladors (2006/66/CE) i la legislació nacional que implementi aquestes directives. Si al costat d'aquest símbol hi apareix imprès un símbol químic, segons especifica la Directiva relativa a piles i acumuladors, significa que la bateria o l'acumulador conté un metall pesant (Hg = mercuri, Cd = cadmi, Pb = plom) en una concentració superior al límit aplicable especificat en la Directiva. Aquest producte s'hauria de lliurar en un dels punts de recollida designats, com per exemple, intercanviant un per un en comprar un producte similar o lliurant-lo en un lloc de recollida autoritzat per al reciclatge de residus d'aparells elèctrics i electrònics (RAEE) i piles i acumuladors. La manipulació inadequada d'aquest tipus de residus podria tenir un impacte negatiu en l'entorn i en la salut humana, a causa de les substàncies potencialment perilloses que normalment estan

associades a l'RAEE. La vostra cooperació a l'hora de rebutjar correctament aquest producte contribuirà a la utilització efectiva dels recursos naturals. Els usuaris tenen dret a retornar les bateries o els acumuladors usats sense cap càrrec. El preu de venda de les bateries i els acumuladors inclou el cost de la gestió ambiental dels residus i no es necessari mostrar l'import d'aquest cost en aquest fullet o en la factura que es lliuri a l'usuari final. Per a més informació sobre el reciclatge d'aquest producte, contacteu amb l'oficina municipal, les autoritats encarregades dels residus, el pla de residus homologat o el servei de recollida d'escombraries domèstiques de la vostra localitat o visiteu www.canon-europe.com/weee, o www.canon-europe.com/battery.

Solo per Unione Europea e SEE (Norvegia, Islanda e Liechtenstein)



Questi simboli indicano che il prodotto non può essere smaltito con i rifiuti domestici, ai sensi della Direttiva RAEE (2012/19/UE), della Direttiva sulle Batterie (2006/66/CE) e/o delle leggi nazionali che attuano tali Direttive. Se sotto il simbolo indicato sopra è riportato un simbolo chimico, in osservanza della Direttiva sulle batterie, tale simbolo indica la presenza di un metallo pesante (Hg = Mercurio, Cd = Cadmio, Pb = Piombo) nella batteria o nell'accumulatore con un livello di concentrazione superiore a una soglia applicabile specificata nella Direttiva sulle batterie. Il prodotto deve essere conferito a un punto di raccolta designato, ad esempio il rivenditore in caso di acquisto di un nuovo prodotto simile oppure un centro di raccolta autorizzato per il riciclaggio di rifiuti di apparecchiature elettriche ed elettroniche (RAEE) nonché di batterie e accumulatori. Un trattamento improprio di questo tipo di rifiuti può avere conseguenze negative sull'ambiente e sulla salute umana a causa delle sostanze potenzialmente nocive solitamente contenute in tali rifiuti. La collaborazione dell'utente per il corretto smaltimento di questo prodotto contribuirà a un utilizzo efficace delle risorse naturali ed eviterà di incorrere in sanzioni amministrative ai sensi dell'art. 255 e successivi del Decreto Legislativo n. 152/06. Per ulteriori informazioni sul riciclaggio di questo prodotto, contattare le autorità locali, l'ente responsabile della raccolta dei rifiuti, un rivenditore autorizzato o il servizio di raccolta dei rifiuti domestici, oppure visitare il sito www.canon-europe.com/weee, o www.canon-europe.com/battery.

Apenas para a União Europeia e AEE (Noruega, Islândia e Liechtenstein)



Estes símbolos indicam que este produto não deve ser eliminado juntamente com o seu lixo doméstico, segundo a Diretiva REEE de 2012/19/UE, a Diretiva de Baterias (2006/66/CE) e/ou a sua legislação nacional que transponha estas Diretivas. Se houver um símbolo químico impresso como mostrado abaixo, de acordo com a Diretiva de Baterias, isto indica que um metal pesado (Hg = Mercúrio, Cd = Cádmiu, Pb = Chumbo) está presente nesta pilha ou acumulador, numa concentração acima de um limite aplicável especificado na Diretiva. Este produto deve ser entregue num ponto de recolha designado, por exemplo num local autorizado de troca quando compra um equipamento novo idêntico, ou num local de recolha autorizado para reciclar equipamento elétrico e eletrónico (EEE) em fim de vida, bem como pilhas e baterias. O tratamento inadequado deste tipo de resíduos pode ter um impacto negativo no ambiente e na saúde humana, devido a substâncias potencialmente perigosas que estão associadas com equipamentos do tipo EEE. A sua cooperação no tratamento correto deste produto irá contribuir para a utilização mais eficaz dos recursos naturais. Para obter mais informações acerca de como reciclar este produto, por favor contacte as suas autoridades locais responsáveis pela matéria, serviço de recolha aprovado para pilhas e baterias ou serviço de recolha de resíduos sólidos domésticos da sua municipalidade, ou visite www.canon-europe.com/weee, ou www.canon-europe.com/battery.

Gælder kun i Europæiske Union og EØS (Norge, Island og Liechtenstein)



Disse symboler betyder, at produktet ikke må bortskaffes sammen med dagrenovation i henhold til WEEE-direktivet (2012/19/EU), batteridirektivet (2006/66/EF) og/eller den lokale lovgivning, som disse direktiver er gennemført i. Hvis der i overensstemmelse med batteridirektivet er trykt et kemisk symbol under det symbol, der er vist ovenfor, betyder det, at batteriet eller akkumulatoren indeholder tungmetaller (Hg = kviksølv, Cd = cadmium, Pb = bly) i en koncentration, som ligger over de grænseværdier, der er beskrevet i batteridirektivet. Produktet skal afleveres på et godkendt indsamlingssted, f.eks. i overensstemmelse med en godkendt én-til-én-procedure, når du indkøber et nyt tilsvarende produkt, eller på et godkendt indsamlingssted for elektronikaffald samt for batterier og akkumulatore. Forkert håndtering af denne type affald kan medføre negative konsekvenser for miljøet og menneskers helbred på grund af de potentielt sundhedsskadelige stoffer, der generelt kan forefindes i elektrisk og elektronisk udstyr. Når du foretager korrekt bortskaffelse af produktet, bidrager du til effektiv brug af naturressourcerne. Kontakt din kommune, den lokale affaldsmyndighed, det lokale affaldsanlæg, eller besøg www.canon-europe.com/weee, eller www.canon-europe.com/battery for at få flere oplysninger om genbrug af dette produkt.

Μόνο για την Ευρωπαϊκή Ένωση και τον ΕΟΧ (Νορβηγία, Ισλανδία και Λιχτενστάιν)



Αυτά τα σύμβολα υποδεικνύουν ότι αυτό το προϊόν δεν πρέπει να απορρίπτεται μαζί με τα οικιακά απορρίμματα, σύμφωνα με την Οδηγία για τα Απόβλητα Ηλεκτρικού και Ηλεκτρονικού Εξοπλισμού (ΑΗΗΕ) (2012/19/ΕΕ), την Οδηγία για τις Ηλεκτρικές Στήλες (2006/66/ΕΚ) ή/και την εθνική νομοθεσία που εφαρμόζει τις Οδηγίες εκείνες. Εάν κάποιο χημικό σύμβολο είναι τυπωμένο κάτω από το σύμβολο που φαίνεται παραπάνω, σύμφωνα με την Οδηγία για τις Ηλεκτρικές Στήλες, υποδηλώνει ότι κάποιο βαρύ μέταλλο (Hg = Υδράργυρος, Cd = Κάδμιο, Pb = Μόλυβδος) υπάρχει στην μπαταρία ή τον συσσωρευτή σε συγκέντρωση μεγαλύτερη από το ισχύον επίπεδο που καθορίζεται στην Οδηγία για τις Ηλεκτρικές Στήλες. Αυτό το προϊόν πρέπει να παραδίδεται σε καθορισμένο σημείο συλλογής, π.χ. σε μια εξουσιοδοτημένη βάση ανταλλαγής όταν αγοράζετε ένα νέο παρόμοιο προϊόν ή σε μια εξουσιοδοτημένη θέση συλλογής για την ανακύκλωση των αποβλήτων ηλεκτρικού και ηλεκτρονικού εξοπλισμού (ΗΗΕ) και των ηλεκτρικών στηλών και συσσωρευτών. Ο ακατάλληλος χειρισμός αυτού του τύπου αποβλήτων μπορεί να έχει αρνητικό αντίκτυπο στο περιβάλλον και την υγεία του ανθρώπου, λόγω δυνητικά επικίνδυνων ουσιών που γενικά συνδέονται με τον ΗΗΕ. Η συνεργασία σας για τη σωστή απόρριψη αυτού του προϊόντος θα συμβάλει στην αποτελεσματική χρήση των φυσικών πόρων. Για περισσότερες πληροφορίες σχετικά με ανακύκλωση αυτού του προϊόντος, επικοινωνήστε με το τοπικό γραφείο της πόλης σας, την υπηρεσία απορριμμάτων, το εγκεκριμένο σχήμα ή την υπηρεσία απόρριψης οικιακών αποβλήτων ή επισκεφθείτε τη διεύθυνση www.canon-europe.com/weee ή www.canon-europe.com/battery.

Gjelder kun den europeiske union og EØS (Norge, Island og Liechtenstein)

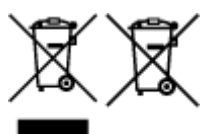

Disse symbolene indikerer at dette produktet ikke skal kastes sammen med husholdningsaffald, i henhold til WEEE-direktivet (2012/19/EU), batteridirektivet (2006/66/EF) og/eller nasjonal lov som har implementert disse direktivene. Hvis et kjemisk symbol vises under symbolet vist ovenfor, i samsvar med

batteridirektivet, indikerer dette at et tungmetall (Hg = kvikksølv, Cd = kadmium, Pb = bly) finnes i batteriet eller akkumulatoren i en konsentrasjon over en gjeldende øvre grense som er spesifisert i batteridirektivet. Produktet må leveres til et dertil egnet innsamlingspunkt, det vil si på en autorisert en-til-en-basis når en kjøper et nytt lignende produkt, eller til et autorisert innsamlingssted for resirkulering av avfall fra elektrisk og elektronisk utstyr (EE-utstyr) og batterier og akkumulatorene. Feil håndtering av denne typen avfall kan være miljø- og helseskadelig på grunn av potensielt skadelige stoffer som ofte brukes i EE-utstyr. Din innsats for korrekt avhending av produktet vil bidra til effektiv bruk av naturressurser. Du kan få mer informasjon om resirkulering av dette produktet ved å kontakte lokale myndigheter, avfallsadministrasjonen, et godkjent program eller husholdningens renovasjonsselskap, eller gå til www.canon-europe.com/weee, eller www.canon-europe.com/battery.

Vain Euroopan unionin sekä ETA:n (Norja, Islanti ja Liechtenstein) alueelle.



Nämä tunnukset osoittavat, että sähkö- ja elektroniikkalaiteromua koskeva direktiivi (SER-direktiivi, 2012/19/EU), paristoista ja akuista annettu direktiivi (2006/66/EY) sekä kansallinen lainsäädäntö kieltävät tuotteen hävittämisen talousjätteen mukana. Jos yllä olevan symbolin alapuolelle on paristodirektiivin mukaisesti painettu kemiallisen aineen tunnus, kyseinen paristo tai akku sisältää raskasmetalleja (Hg = elohopea, Cd = kadmium, Pb = lyijy) enemmän kuin paristodirektiivin salliman määrän. Tuote on vietävä asianmukaiseen keräyspisteeseen, esimerkiksi kodinkoneliikkeeseen uutta vastaavaa tuotetta ostettaessa tai viralliseen sähkö- ja elektroniikkalaiteromun tai paristojen ja akkujen keräyspisteeseen. Sähkö- ja elektroniikkalaiteromun virheellinen käsittely voi vahingoittaa ympäristöä ja ihmisten terveyttä, koska laitteet saattavat sisältää ympäristölle ja terveydelle haitallisia aineita. Tuotteen asianmukainen hävittäminen säästää myös luonnonvaroja. Jos haluat lisätietoja tämän tuotteen kierrätyksestä, ota yhteys kunnan jätehuoltoviranomaisiin tai käyttämäsi jätehuolto-yhtiöön tai käy osoitteessa www.canon-europe.com/weee, tai www.canon-europe.com/battery.

Endast för Europeiska unionen och EES (Norge, Island och Liechtenstein)



De här symbolerna visar att produkten inte får sorteras och slängas som hushållsavfall enligt WEEE-direktivet (2012/19/EU), batteridirektivet (2006/66/EG) och/eller nationell lagstiftning som implementerar dessa direktiv. Om en kemisk symbol förekommer under ovanstående symbol innebär detta enligt Batteridirektivet att en tungmetall (Hg = Kvikksilver, Cd = Kadmium, Pb = Bly) förekommer i batteriet eller akkumulatoren med en koncentration som överstiger tillämplig gräns som anges i Batteridirektivet. Produkten ska lämnas in på en avsedd insamlingsplats, t.ex. på en återvinningsstation auktoriserad att hantera elektrisk och elektronisk utrustning (EE-utrustning) samt batterier och akkumulatorene eller hos handlare som är auktoriserade att byta in varor då nya, motsvarande köps (en mot en). Olämplig hantering av avfall av den här typen kan ha negativ inverkan på miljön och människors hälsa på grund av de potentiellt farliga ämnen som kan återfinnas i elektrisk och elektronisk utrustning. Din medverkan till en korrekt avfallshantering av produkten bidrar till effektiv användning av naturresurserna. Om du vill ha mer information om var du kan lämna in den här produkten, kontakta ditt lokala kommunkontor, berörd myndighet eller företag för avfallshantering eller se www.canon-europe.com/weee, eller www.canon-europe.com/battery.

Pouze Evropská unie a EHP (Norsko, Island a Lichtenštejsko)



Tento symbol znamená, že podle směrnice OEEZ (2012/19/EU), směrnice o bateriích (2006/66/ES) a/ nebo podle vnitrostátních právních prováděcích předpisů k těmto směrnicím nemá být tento výrobek likvidován s odpadem z domácností. Je-li v souladu s požadavky směrnice o bateriích vytištěna pod výše uvedeným symbolem chemická značka, udává, že tato baterie nebo akumulátor obsahuje těžké kovy (Hg = rtuť, Cd = kadmium, Pb = olovo) v koncentraci vyšší, než je příslušná hodnota předepsaná směrnicí. Tento výrobek má být vrácen do určeného sběrného místa, např. v rámci autorizovaného systému odběru jednoho výrobku za jeden nově prodaný podobný výrobek, nebo do autorizovaného sběrného místa pro recyklaci odpadních elektrických a elektronických zařízení (OEEZ), baterií a akumulátorů. Nevhodné nakládání s tímto druhem odpadu by mohlo mít negativní dopad na životní prostředí a lidské zdraví, protože elektrická a elektronická zařízení zpravidla obsahují potenciálně nebezpečné látky. Vaše spolupráce na správné likvidaci tohoto výrobku napomůže efektivnímu využívání přírodních zdrojů. Chcete-li získat podrobné informace týkající se recyklace tohoto výrobku, obraťte se prosím na místní úřad, orgán pro nakládání s odpady, schválený systém nakládání s odpady či společnost zajišťující likvidaci domovního odpadu, nebo navštivte webové stránky www.canon-europe.com/weee nebo www.canon-europe.com/battery.

Csak az Európai Unió és az EGT (Norvégia, Izland és Liechtenstein) országaiiban



Ezek a szimbólumok azt jelzik, hogy a termék hulladékkezelése a háztartási hulladéktól különválasztva, az elektromos és elektronikus berendezések hulladékairól (WEEE) szóló (2012/19/EU) irányelvnek és az elemekről és akkumulátorokról, valamint a hulladék elemekről és akkumulátorokról szóló (2006/66/EK) irányelvnek megfelelően és/vagy ezen irányelveknek megfelelő helyi előírások szerint történik. Amennyiben a fent feltüntetett szimbólum alatt egy vegyjel is szerepel, az elemekről és akkumulátorokról szóló irányelvben foglaltak értelmében ez azt jelzi, hogy az elem vagy az akkumulátor az irányelvben meghatározott határértéknél nagyobb mennyiségben tartalmaz nehézfémeket (Hg = higany, Cd = kadmium, Pb = ólom). E terméket az arra kijelölt gyűjtőhelyre kell juttatni – pl. hasonló termék vásárlásakor a régi becserélésére vonatkozó hivatalos program keretében, vagy az elektromos és elektronikus berendezések (EEE) hulladékainak gyűjtésére, valamint a hulladék elemek és hulladék akkumulátorok gyűjtésére kijelölt hivatalos gyűjtőhelyre. Az ilyen jellegű hulladékok nem előírászerű kezelése az elektromos és elektronikus berendezésekhez (EEE) általánosan kapcsolható potenciálisan veszélyes anyagok révén hatással lehet a környezetre és az egészségre. E termék megfelelő leselejtezésével Ön is hozzájárul a természeti források hatékony használatához. A termék újrahasznosítását illetően informálódjon a helyi polgármesteri hivatalnál, a helyi közterület-fenntartó vállalatnál, a hivatalos hulladéklerakó telephelyen vagy a háztartási hulladék begyűjtését végző szolgáltatónál, illetve látogasson el a www.canon-europe.com/weee, vagy www.canon-europe.com/battery internetes oldalra.

Tylko dla krajów Unii Europejskiej oraz EOG (Norwegia, Islandia i Liechtenstein)



Te symbole oznaczają, że produktu nie należy wyrzucać razem z odpadami gospodarstwa domowego, zgodnie z dyrektywą WEEE w sprawie zużytego sprzętu elektrycznego i elektronicznego (2012/19/UE) lub dyrektywą w sprawie baterii (2006/66/WE) bądź przepisami krajowymi wdrażającymi te dyrektywy. Jeśli pod powyższym symbolem znajduje się symbol chemiczny, zgodnie z dyrektywą w sprawie baterii oznacza to, że bateria lub akumulator zawiera metal ciężki (Hg = rtęć, Cd = kadm, Pb = ołów) w stężeniu przekraczającym odpowiedni poziom określony w dyrektywie w sprawie baterii. Użytkownicy baterii i akumulatorów mają obowiązek korzystać z dostępnego programu zwrotu, recyklingu i utylizacji baterii oraz akumulatorów. Niewłaściwe postępowanie z tego typu odpadami może mieć wpływ na środowisko i zdrowie ludzi ze względu na substancje potencjalnie niebezpieczne, związane ze zużytym sprzętem elektrycznym i elektronicznym. Państwa współpraca w zakresie właściwej utylizacji tego produktu przyczyni się do efektywnego wykorzystania zasobów naturalnych. W celu uzyskania informacji o sposobie recyklingu tego produktu prosimy o kontakt z właściwym urzędem miejskim lub zakładem gospodarki komunalnej bądź zapraszamy na stronę www.canon-europe.com/weee, lub www.canon-europe.com/battery.

Plati len pre štáty Európskej únie a EHP (Nórsko, Island a Lichtenštajnsko)



Tieto symboly označujú, že podľa Smernice o odpade z elektrických a elektronických zariadení (OEEZ) 2012/19/EÚ, Smernice o batériách (2006/66/ES) a podľa platnej legislatívy Slovenskej republiky sa tento produkt nesmie likvidovať spolu s komunálnym odpadom. Ak je chemická značka vytlačená pod vyššie uvedeným symbolom, znamená to, že táto batéria alebo akumulátor obsahuje ťažký kov (Hg = ortuť, Cd = kadmium, Pb = olovo) v koncentrácii vyššej, ako je príslušná povolená hodnota stanovená v Smernici o batériách. Produkt je potrebné odovzdať do určenej zberne, napr. prostredníctvom výmeny za kúpu nového podobného produktu, alebo na autorizované zberné miesto, ktoré spracúva odpad z elektrických a elektronických zariadení (EEZ), batérií a akumulátorov. Nesprávna manipulácia s takýmto typom odpadu môže mať negatívny vplyv na životné prostredie a ľudské zdravie, pretože elektrické a elektronické zariadenia obsahujú potenciálne nebezpečné látky. Spolupracou na správnej likvidácii tohto produktu prispějete k účinnému využívaniu prírodných zdrojov. Ďalšie informácie o recyklácii tohto produktu získate od miestneho úradu, úradu životného prostredia, zo schváleného plánu OEEZ alebo od spoločnosti, ktorá zaisťuje likvidáciu komunálneho odpadu. Viac informácií nájdete aj na webovej stránke: www.canon-europe.com/weee, alebo www.canon-europe.com/battery.

Üksnes Euroopa Liit ja EMP (Norra, Island ja Liechtenstein)



Antud sümbolid viitavad sellele, et vastavalt elektri- ja elektroonikaseadmete jäätmeid käsitlevale direktiivile (2012/19/EL), patareisid ja akusid ning patarei- ja akujäätmeid käsitlevale direktiivile (2006/66/EÜ) ja/või nimetatud direktiive rakendavatele riiklikele õigusaktidele ei või seda toodet koos olmejäätmetega ära visata. Kui keemiline sümbol on trükitud eespool toodud sümboli alla, siis tähendab see, et antud patareis või akus leiduva raskemetalli (Hg = elavhõbe, Cd = kaadmium, Pb = plii) kontsentratsioonitase on kõrgem kui patareisid ja akusid ning patarei- ja akujäätmeid käsitlevas direktiivis sätestatud piirmäär. Antud tootest tekkinud jäätmed tuleb anda vastavasse kogumispunkti, nt müügipunkti, mis on volitatud üks ühe vastu vahetama, kui ostate uue sarnase toote, või vastavasse elektri- ja lektroonikaseadmete jäätmete ning patareide ja akude ümbertöötlemiseks mõeldud kogumispunkti. Antud liiki jäätmete vale käitlemine võib kahjustada keskkonda ja inimeste tervist elektri- ja elektroonikajäätmetes tavaliselt leiduvate potentsiaalselt ohtlike ainete tõttu. Antud tootest tekkinud

žātmete nūetekohase kōrvaldamisega aitate kasutada loodusvarasid efektiivselt. Tāiendava teabe saamiseks elektri- ja elektroonikaseadmetest tekkinud žātmete ning patarei- ja akujātmete tagastamise ja ūbertōōtlemise kohta vōtke ūhendust kohaliku omavalitsusega, asjakohase valitsusasutusega, asjakohase tootjavastutusorganisationsiooniga vōi olmejātmete kāitlejaga. Lisateavet leitāte ka Interneti-lehekūljelt www.canon-europe.com/weee vōi www.canon-europe.com/battery.

Tikai Eiropas Savienībai un EEZ (Norvēģijai, Islandei un Lihtenšteinai)

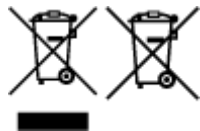

Šie simboli norāda, ka atbilstoši ES Direktīvai (2012/19/ES) par elektrisko un elektronisko iekārtu atkritumiem (EEIA), Direktīvai (2006/66/EK) par baterijām un akumulatoriem, un akumulatoru atkritumiem, ar ko atceļ Direktīvu 91/157/EEK, un vietējiem tiesību aktiem šo izstrādājumu nedrīkst izmest kopā ar sadzīves atkritumiem. Ja zem iepriekš norādītā simbola ir uzdrukāts ķīmiskais simbols, saskaņā ar direktīvu par baterijām un akumulatoriem tas nozīmē, ka šīs baterijas vai akumulatori satur smagos metālus (Hg = dzīvsudrabs, Cd = kadmījs, Pb = svins) un to koncentrācijas līmenis pārsniedz direktīvā par baterijām un akumulatoriem minēto piemērojamo sliekšni. Šis izstrādājums ir jānodod piemērotā savākšanas vietā, piemēram, apstiprinātā veikalā, kur iegādājaties līdzīgu jaunu produktu un atstājat veco, vai apstiprinātā vietā izlietotu elektrisko un elektronisko iekārtu un bateriju un akumulatoru pārstrādei. Nepareiza šāda veida atkritumu apsaimniekošana var apdraudēt vidi un cilvēka veselību tādu iespējami bīstamu vielu dēļ, kas parasti ir elektriskajās un elektroniskajās iekārtās. Jūsu atbalsts pareizā šāda veida atkritumu apsaimniekošanā sekmēs efektīvu dabas resursu izmantošanu. Lai saņemtu pilnīgāku informāciju par šāda veida izstrādājumu nodošanu otrreizējai pārstrādei, sazinieties ar vietējo pašvaldību, atkritumu savākšanas atbildīgo dienestu, pilnvaroto organizāciju vai iestādi, kas veic sadzīves atkritumu apsaimniekošanu, vai apmeklējiet tīmekļa vietni www.canon-europe.com/weee, vai www.canon-europe.com/battery.

Tik Europos Sajungai ir EEE (Norvegijai, Islandijai ir Lichtenšteinai)



Šie simboli reiškia, kad šio gaminio negalima išmesti į buitines atliekas, kaip reikalaujama WEEE Direktyvoje (2012/19/ES) ir Baterijų direktyvoje (2006/66/EB) ir (ar) jūsų šalies nacionaliniuose įstatymuose, kuriais šios Direktyvos yra įgyvendinamos. Jeigu cheminio ženklo simbolis yra nurodytas žemiau šio ženklo, tai reiškia, kad vadovaujantis Baterijų direktyvą, baterijų ar akumuliatorių sudėtyje yra sunkiųjų metalų (Hg = gyvsidabris, Cd = kadmio, Pb = švino), kurių koncentracija viršija Baterijų direktyvoje nurodytas leistinas ribas. Šį gaminį reikia pristatyti į specialųjį surinkimo punktą, pavyzdžiui, mainais, kai jūs perkate naują panašų gaminį, arba į specialiąją surinkimo vietą, kurioje perdirbamos elektrinės ir elektroninės įrangos atliekos bei naudotos baterijos ir akumuliatoriai. Dėl netinkamo šio tipo atliekų tvarkymo gali nukentėti aplinka ir iškilti grėsmė žmogaus sveikatai dėl galimai kenksmingų medžiagų, iš esmės susijusių su elektrine ir elektronine įranga. Bendradarbiaudami ir teisingai utilizuodami šiuos gaminius, jūs padėsite efektyviai naudoti gamtinius išteklius. Daugiau informacijos apie gaminio perdirbimą jums gali suteikti vietinis biuras, atliekų tvarkymo bendrovė, sertifikuoti organai ar buitinių atliekų surinkimo įmonės. Taip pat siūloma apsilankyti interneto svetainėje www.canon-europe.com/weee, arba www.canon-europe.com/battery.

Samo za Evropsko unijo in EGP (Norveška, Islandija in Lihtenštajn)

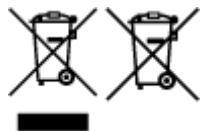

Ti simboli pomenijo, da tega izdelka skladno z Direktivo OEEO (2012/19/EU), Direktivo 2006/66/ES in/ali nacionalno zakonodajo, ki uvaja ti direktivi, ne smete odlagati z nesortiranimi gospodinjskimi odpadki. Če je pod zgoraj prikazanim simbolom natisnjen kemijski simbol, to v skladu z Direktivo pomeni, da je v tej bateriji ali akumulatorju prisotna težka kovina (Hg = živo srebro, Cd = kadmij, Pb = svinec), in sicer v koncentraciji, ki je nad relevantno mejno vrednostjo, določeno v Direktivi. Ta izdelek je potrebno odnesti na izbrano zbirno mesto, t. j. pooblaščen trgovino, kjer ob nakupu novega (podobnega) izdelka vrnete starega, ali na pooblaščen zbirno mesto za ponovno uporabo odpadne električne in elektronske opreme (EEO) ter baterij in akumulatorjev. Neustrezno ravnanje s to vrsto odpadkov lahko negativno vpliva na okolje in človeško zdravje zaradi potencialno nevarnih snovi, ki so pogosto povezane z EEO. Vaše sodelovanje pri pravilnem odlaganju tega izdelka predstavlja pomemben prispevek k smotrni izrabi naravnih virov. Za več informacij o ponovni uporabi tega izdelka se obrnite na lokalni mestni urad, pristojno službo za odpadke, predstavnika pooblaščenega programa za obdelavo odpadkov ali na lokalno komunalo. Lahko pa tudi obiščete našo spletno stran www.canon-europe.com/weee, ali www.canon-europe.com/battery.

Само за Европейския съюз и ЕИП (Норвегия, Исландия и Лихтенщайн)



Тези символи показват, че този продукт не трябва да се изхвърля заедно с битовите отпадъци съгласно Директивата за ИУЕЕО (2012/19/ЕС), Директивата за батерии (2006/66/ЕО) и/или Вашето национално законодателство, прилагащо тези Директиви. Ако под показания горе символ е отпечатан символ за химически елемент, съгласно разпоредбите на Директивата за батерии, този втори символ означава наличието на тежък метал (Hg = живак, Cd = кадмий, Pb = олово) в батерията или акумулатора в концентрация над указаната граница за съответния елемент в Директивата. Този продукт трябва да бъде предаден в предназначен за целта пункт за събиране, например на база размяна, когато купувате нов подобен продукт, или в одобрен събирателен пункт за рециклиране на излязло от употреба електрическо и електронно оборудване (ИУЕЕО), батерии и акумулатори. Неправилното третиране на този тип отпадъци може да доведе до евентуални отрицателни последици за околната среда и човешкото здраве поради потенциално опасните вещества, които обикновено са свързани с ЕЕО. В същото време Вашето съдействие за правилното изхвърляне на този продукт ще допринесе за ефективното използване на природните ресурси. За повече информация относно това къде можете да предадете за рециклиране на този продукт, моля свържете се с Вашите местни власти, с органа, отговорен за отпадъците, с одобрената система за ИУЕЕО или с Вашата местна служба за битови отпадъци, или посетете www.canon-europe.com/weee, или www.canon-europe.com/battery.

Doar pentru Uniunea Europeană și EEA (Norvegia, Islanda și Liechtenstein)



Aceste simboluri indică faptul că acest produs nu trebuie aruncat împreună cu deșeurile menajere, în conformitate cu Directiva DEEE (2012/19/UE), Directiva referitoare la baterii (2006/66/CE) și/sau legile dvs. naționale ce implementează aceste Directive. Dacă un simbol chimic este imprimat sub simbolul de

mai sus, în conformitate cu Directiva referitoare la baterii, acest simbol indică prezența în baterie sau acumulator a unui metal greu (Hg = Mercur, Cd = Cadmiu, Pb = Plumb) într-o concentrație mai mare decât pragul admis specificat în Directiva referitoare la baterii. Acest produs trebuie înmănat punctului de colectare adecvat, ex: printr-un schimb autorizat unu la unu atunci când cumpărați un produs nou similar sau la un loc de colectare autorizat pentru reciclarea reziduurilor de echipament electric și electronic (EEE) și baterii și acumulatori. Administrarea neadecvată a acestui tip de deșeuri, ar putea avea un impact asupra mediului și asupra sănătății umane datorită substanțelor cu potențial de risc care sunt în general asociate cu EEE. Cooperarea dvs. în direcția reciclării corecte a acestui produs va contribui la o utilizare eficientă a resurselor naturale. Pentru mai multe informații despre reciclarea acestui produs, vă rugăm să contactați biroul dvs. local, autoritățile responsabile cu deșeurile, schema aprobată sau serviciul dvs. responsabil cu deșeurile menajere sau vizitați-ne la www.canon-europe.com/wEEE, sau www.canon-europe.com/battery.

Samo za Europsku uniju i EEA (Norveška, Island i Lihtenštajn)

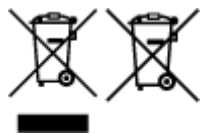

Oznaka pokazuje da se ovaj proizvod ne smije odlagati s komunalnim i ostalim vrstama otpada, u skladu s direktivom WEEE (2012/19/EC), Direktivom o baterijama (2006/66/EC) i Pravilnikom o gospodarenju otpadnim baterijama i akumulatorima te Pravilnikom o gospodarenju otpadnim električnim i elektroničkim uređajima i opremom. Ako je ispod prethodno prikazane oznake otisnut kemijski simbol, u skladu s Direktivom o baterijama, to znači da se u ovoj bateriji ili akumulatoru nalazi teški metal (Hg = živa, Cd = kadmij, Pb = olovo) i da je njegova koncentracija iznad razine propisane u Direktivi o baterijama. Ovaj bi proizvod trebalo predati ovlaštenom skupljaču EE otpada ili prodavatelju koji je dužan preuzeti otpadni proizvod po sistemu jedan za jedan, ukoliko isti odgovara vrsti te je obavljao primarne funkcije kao i isporučena EE oprema. Otpadne baterije i akumulatori predaju se ovlaštenom skupljaču otpadnih baterija ili akumulatora ili prodavatelju bez naknade i obveze kupnje za krajnjeg korisnika. Neodgovarajuće rukovanje ovom vrstom otpada može utjecati na okoliš i ljudsko zdravlje zbog potencijalno opasnih supstanci koje se najčešće nalaze na takvim mjestima. Vaša suradnja u pravilnom zbrinjavanju ovog proizvoda pridonijet će djelotvornom iskorištavanju prirodnih resursa. Dodatne informacije o recikliranju ovog proizvoda zatražite od svog lokalnog gradskog ureda, službe za zbrinjavanje otpada, odobrenog programa ili komunalne službe za uklanjanje otpada ili pak na stranicama www.canon-europe.com/wEEE ili www.canon-europe.com/battery.

Korisnici u Srbiji

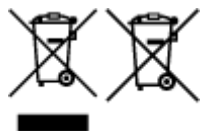

Ovaj simbol označava da ovaj proizvod ne sme da se odlaže sa ostalim kućnim otpadom, u skladu sa WEEE Direktivom (2012/19/EU), Direktivom o baterijama (2006/66/EC) i nacionalnim zakonima. Ukoliko je ispod gore navedenog simbola odštampan hemijski simbol, u skladu sa Direktivom o baterijama, ovaj simbol označava da su u ovoj bateriji ili akumulatoru prisutni teški metali (Hg – živa, Cd – kadmijum, Pb - olovo) u koncentracijama koje premašuju prihvatljivi prag naveden u Direktivi o baterijama. Ovaj proizvod treba predati određenom centru za prikupljanje, npr. po principu „jedan-za-jedan“ kada kupujete sličan novi proizvod, ili ovlašćenom centru za prikupljanje za reciklažu istrošene električne i elektronske opreme (EEE), baterija i akumulatora. Nepravilno rukovanje ovom vrstom otpada može imati negativne posledice po životnu sredinu i ljudsko zdravlje usled potencijalno opasnih materijala koji se uglavnom vezuju za EEE. Vaša saradnja na ispravnom odlaganju ovog proizvoda će doprineti efikasnom korišćenju prirodnih resursa. Više informacija o tome kako možete da reciklirate ovaj proizvod potražite od lokalnih gradskih

vlasti, komunalne službe, odobrenog plana reciklaže ili servisa za odlaganje kućnog otpada, ili posetite stranicu www.canon-europe.com/weee, ili www.canon-europe.com/battery.



Legal Restrictions on Printing

It may be unlawful to print the following documents.

The list provided is non-exhaustive. When in doubt, check with a legal representative in your jurisdiction.

- Paper money
- Money orders
- Certificates of deposit
- Postage stamps (canceled or uncanceled)
- Identifying badges or insignias
- Selective service or draft papers
- Checks or drafts issued by governmental agencies
- Motor vehicle licenses and certificates of title
- Traveler's checks
- Food stamps
- Passports
- Immigration papers
- Internal revenue stamps (canceled or uncanceled)
- Bonds or other certificates of indebtedness
- Stock certificates
- Copyrighted works/works of art without permission of copyright owner

Basic Printing Workflow

- ▶ **Printing Photos from a Computer (Windows)**
- ▶ **Printing Photos from a Computer (Mac OS)**

Printing Photos from a Computer (Windows)

This section describes how to print photos with a software application on your computer.

1. Open the paper support (A) of the rear tray, then extend the paper support extension (B).
2. Open the paper output tray (C) gently.
3. Open the output tray extension (D), then pull out the paper output support (E).

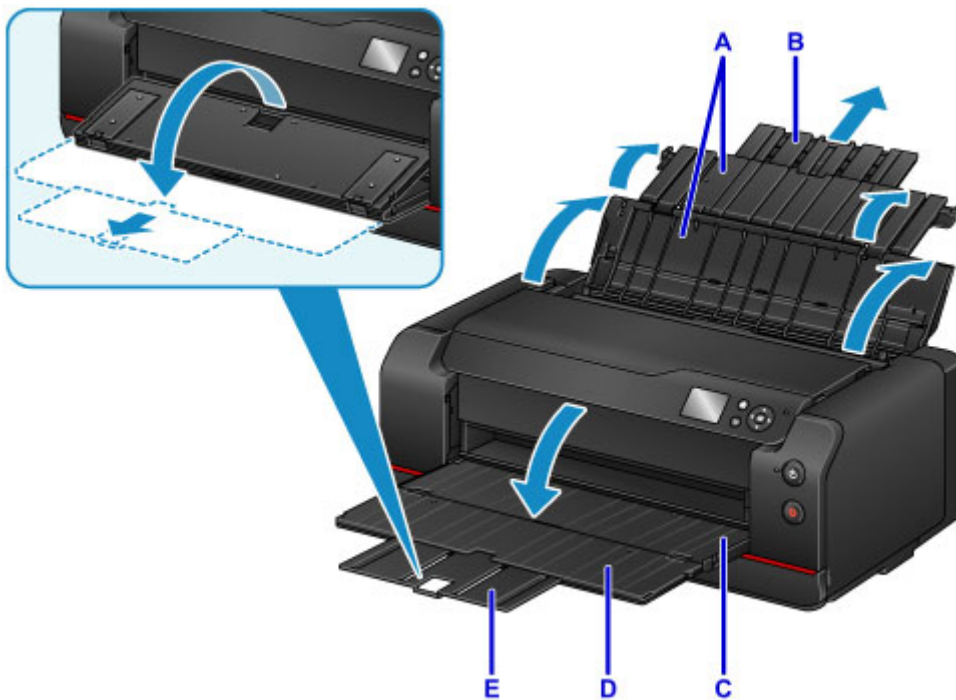

4. Open the feed slot cover (F).

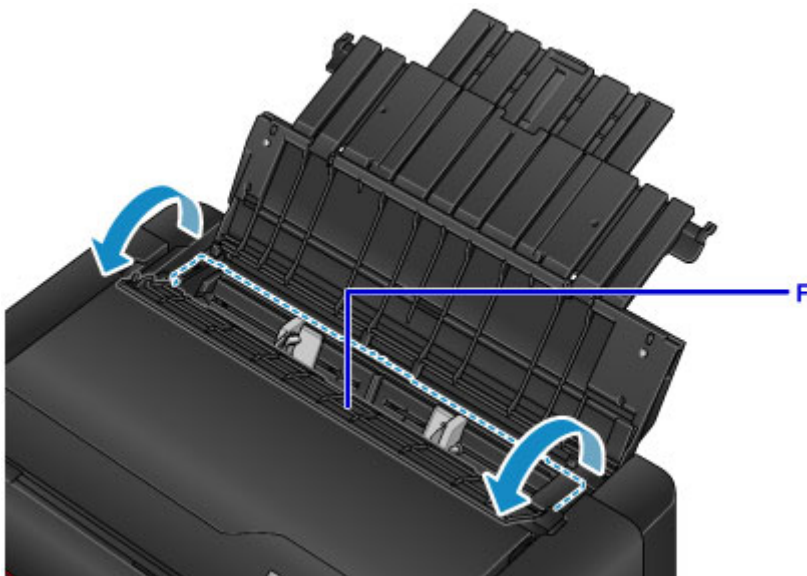

5. Load paper vertically WITH THE PRINT SIDE FACING YOU.
6. Align the paper guides (G) with the paper width.

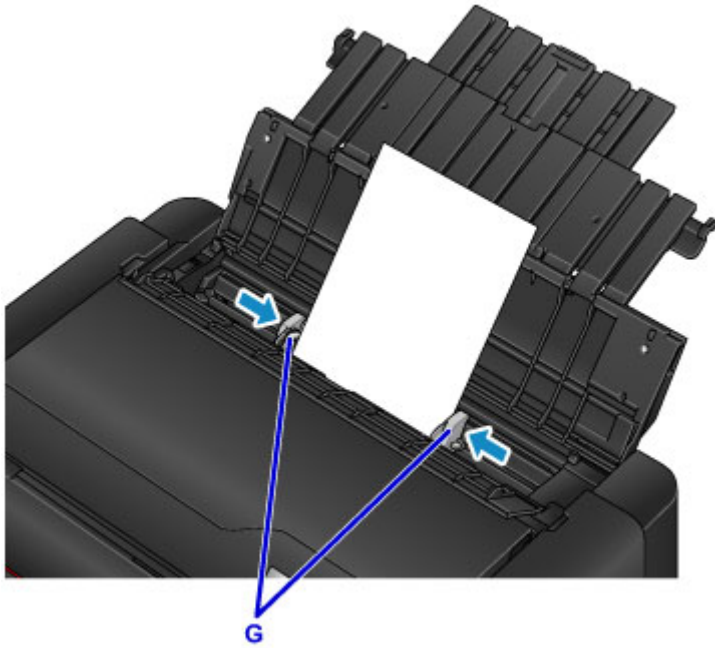

7. Close the feed slot cover gently.

The paper information registration screen for the rear tray is displayed on the LCD.



8. Select the size and type of paper loaded in the rear tray at **Page size** and **Type**, select **Register**, then press the **OK** button.

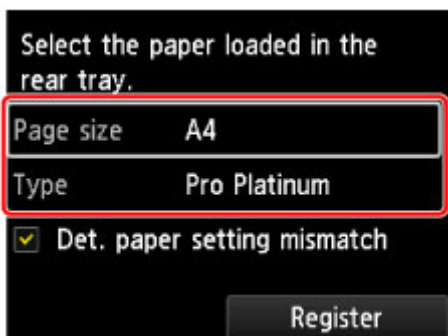

If a message is displayed on the screen, follow the directions in the message to complete registration.

9. Select **Print** from the software application's menu.

In general, select **Print** on the **File** menu to open the **Print** dialog box.

10. Select your model name and click **Preferences** (or **Properties**).

The printer driver setup window appears.

Note

- Depending on software application you use, command names or menu names may vary and there may be more steps. For details, refer to the user's manual of your software application.

11. Select a frequently used profile.

In **Commonly Used Settings** on the **Quick Setup** tab, select a printing profile suited for the purpose.

When you select a printing profile, the **Additional Features**, **Media Type**, and **Printer Paper Size** settings are automatically switched to the values that were preset.

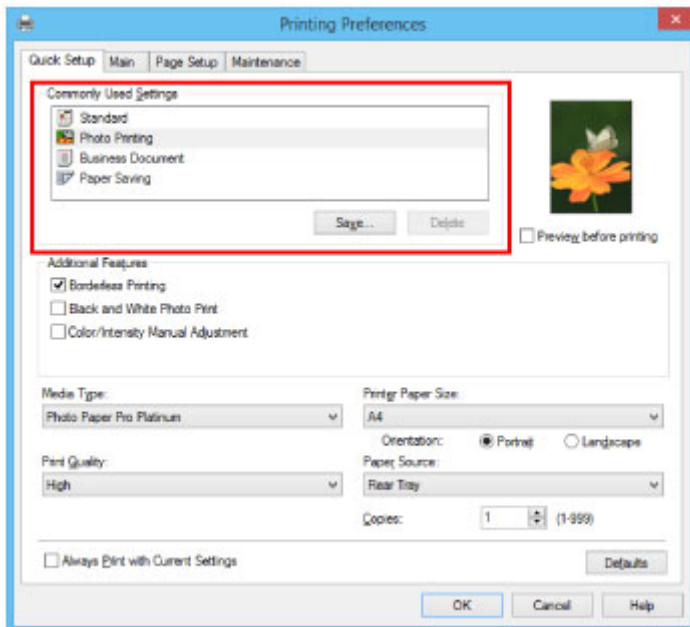

12. Select the paper source.

Select the rear tray in which you loaded the paper at **Paper Source**.

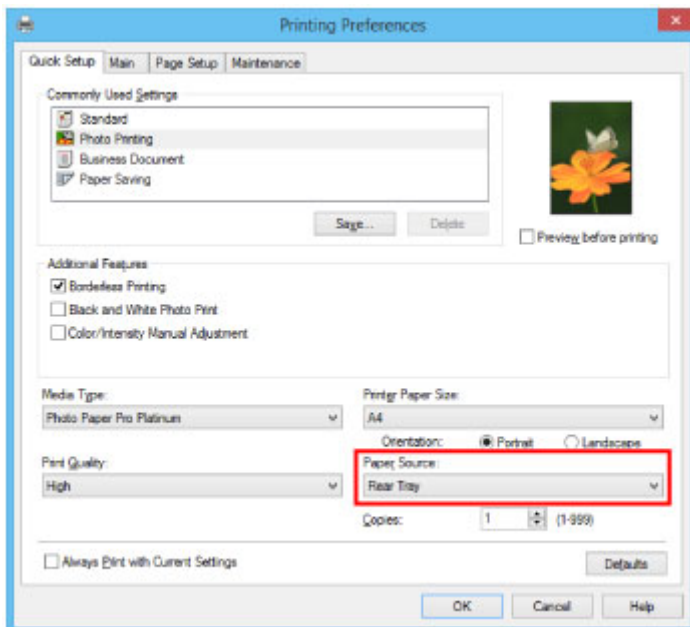

13. After completing the setup, click **OK**, then execute print.

▶▶▶ Note

- The printer driver setup window enables you to specify various settings for printing.
 - Printing from Application Software (Windows Printer Driver)

Printing Photos from a Computer (Mac OS)

This section describes how to print photos with a software application on your computer.

1. Open the paper support (A) of the rear tray, then extend the paper support extension (B).
2. Open the paper output tray (C) gently.
3. Open the output tray extension (D), then pull out the paper output support (E).

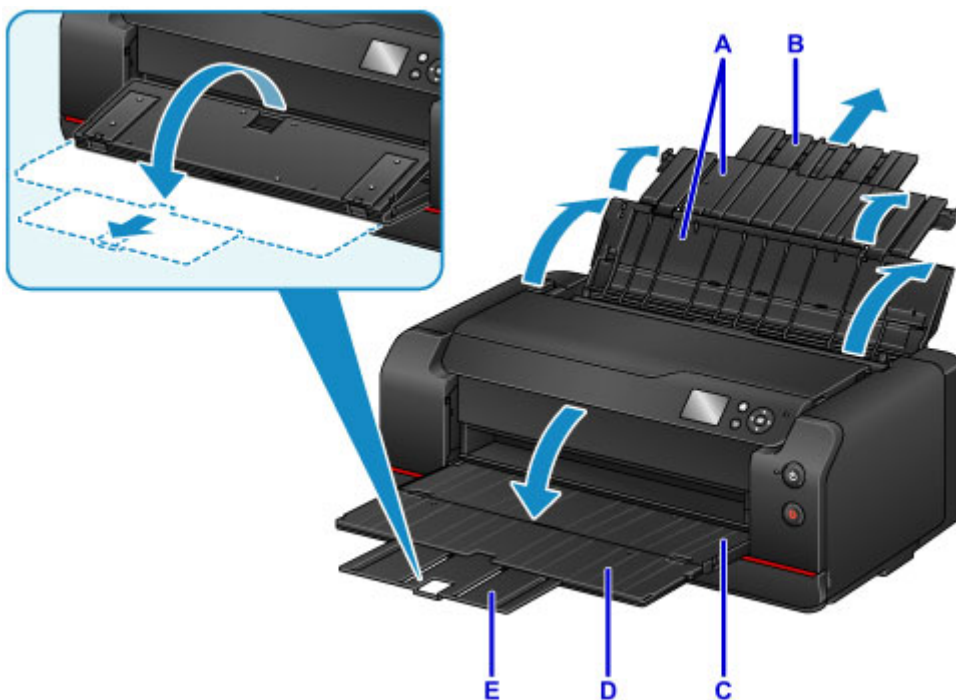

4. Open the feed slot cover (F).

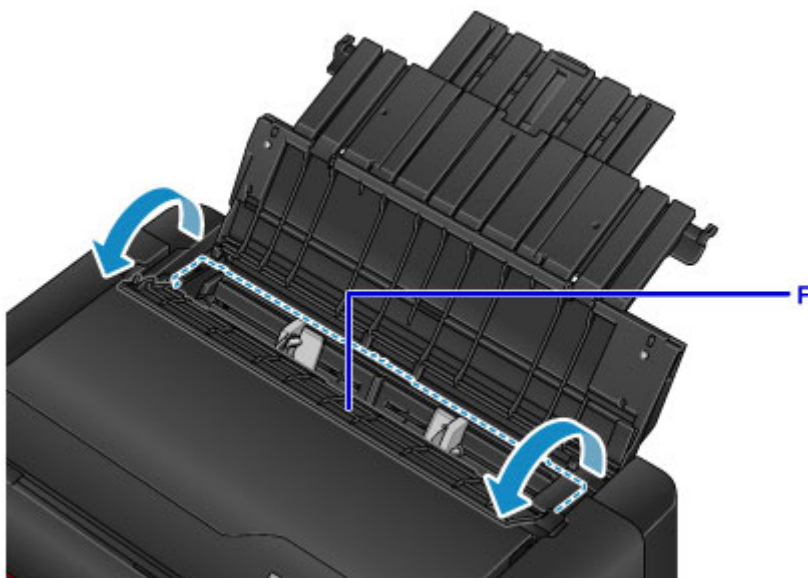

5. Load paper vertically WITH THE PRINT SIDE FACING YOU.
6. Align the paper guides (G) with the paper width.

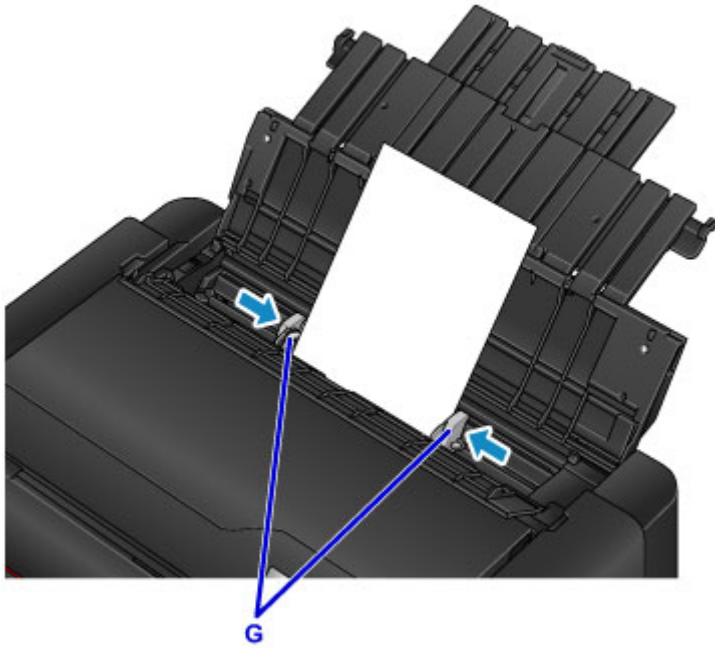

7. Close the feed slot cover gently.

The paper information registration screen for the rear tray is displayed on the LCD.



8. Select the size and type of paper loaded in the rear tray at **Page size** and **Type**, select **Register**, then press the **OK** button.

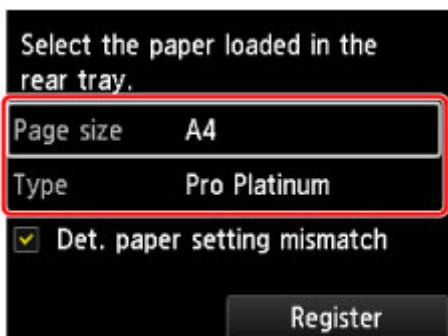

If a message is displayed on the screen, follow the directions in the message to complete registration.

9. Select **Print** from the software application's menu.

In general, select **Print...** from the **File** menu to open the Print dialog.

Note

- For details on the operations of software application you use, refer to the user's manual of your software application.

10. Select your model from the **Printer** list.

Click **Show Details** to switch the Setup window to the detailed display.

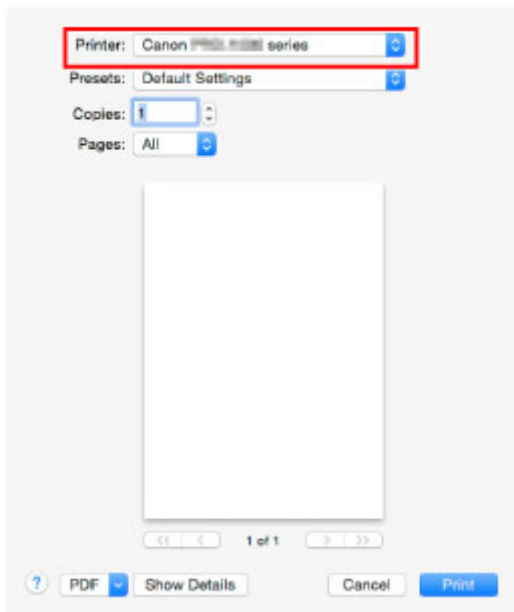

11. Select the paper size.

For **Paper Size**, select the paper size to be used.

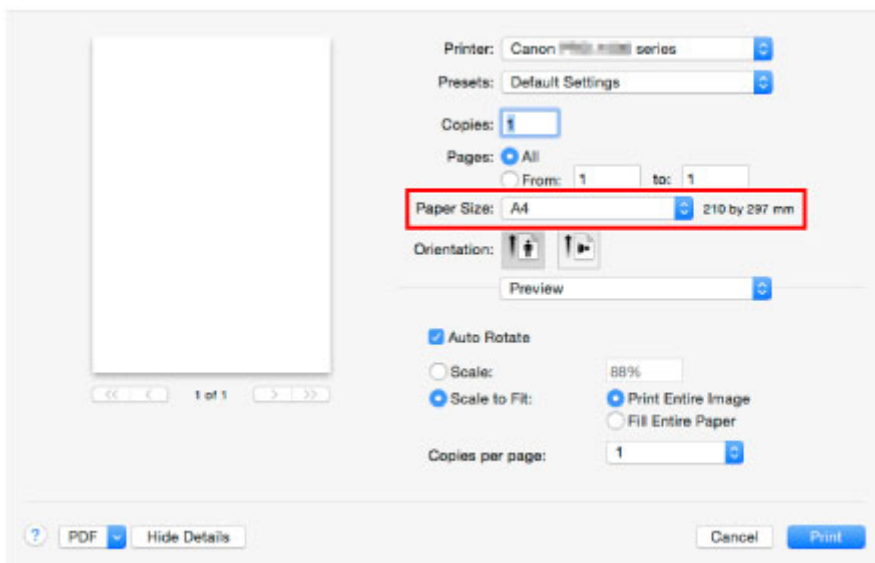

12. Select **Quality & Media** from the pop-up menu.

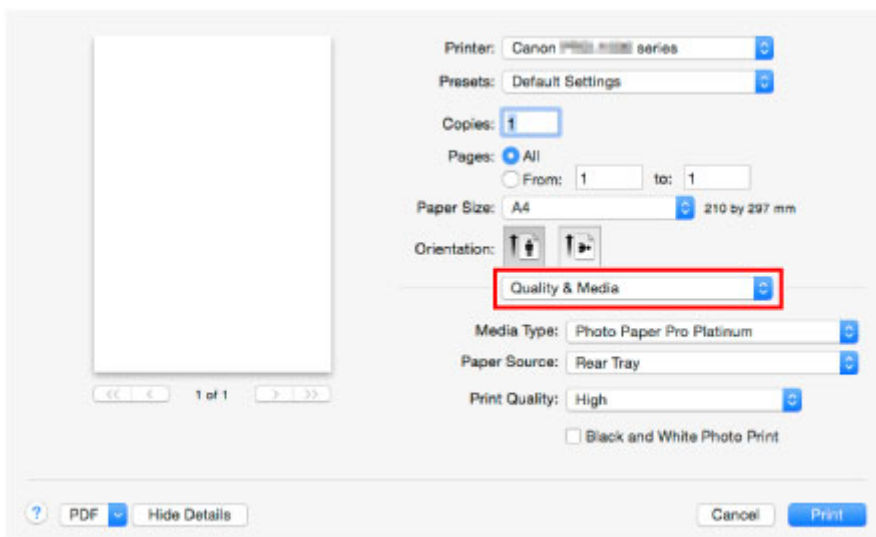

13. Select the media type.

For **Media Type**, select the same paper type loaded in the printer.

14. Select the paper source.

Select the rear tray in which you loaded the paper at **Paper Source**.

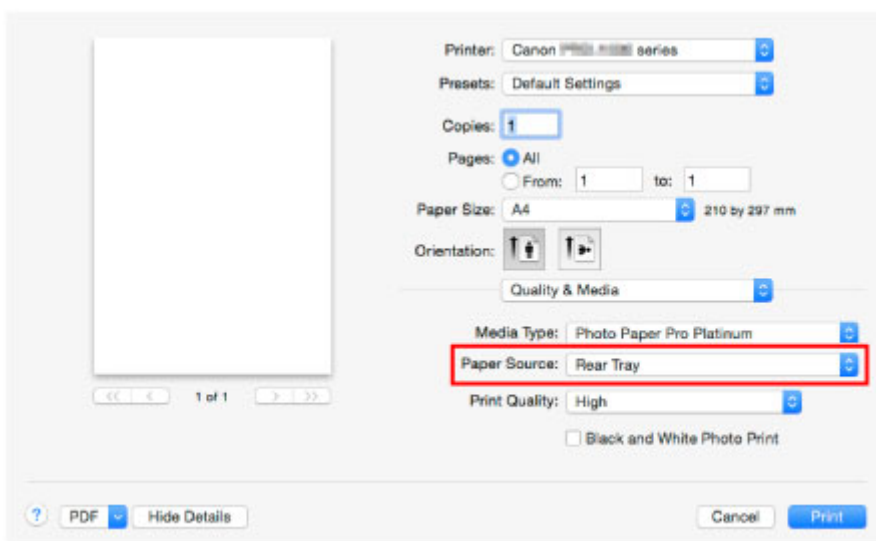

15. After completing the setup, click **Print**, then execute print.

▶▶▶ Note

- The Print dialog of the printer driver enables you to specify various settings for printing.
 - [Printing from Application Software \(Mac OS Printer Driver\)](#)

Enhanced Printing Options

▶ Printing from Computer

- Printing from Application Software (Windows Printer Driver)
 - Printing with Easy Setup 📌 **Basics**
 - Paper Settings on the Printer Driver and the Printer (Media Type)
 - Paper Settings on the Printer Driver and the Printer (Paper Size)
 - Setting a Page Size and Orientation
 - Setting the Number of Copies and Printing Order
 - Setting the Stapling Margin
 - Execute Borderless Printing
 - Fit-to-Page Printing
 - Scaled Printing
 - Page Layout Printing
 - Tiling/Poster Printing
 - Booklet Printing
 - Duplex Printing
 - Stamp/Background Printing
 - Registering a Stamp
 - Registering Image Data to be Used as a Background
 - Printing on Postcards
 - Changing the Clear Coating Settings
 - Switching the Paper Source to Match the Purpose
 - Displaying the Print Results before Printing
 - Setting Paper Dimensions (Custom Size)
 - Editing the Print Document or Reprinting from the Print History
 - Changing the Print Quality and Correcting Image Data
 - Setting the Print Quality Level (Custom)
 - Printing a Color Document in Monochrome
 - Adjusting Tone
 - Specifying Color Correction
 - Optimal Photo Printing of Image Data
 - Adjusting Colors with the Printer Driver

- Printing with ICC Profiles
 - Interpreting the ICC Profile
 - Adjusting Color Balance
 - Adjusting Brightness
 - Adjusting Contrast
- **Printing from Application Software (Mac OS Printer Driver)**
 - **Printing with Easy Setup 📄Basics**
 - Paper Settings on the Printer Driver and the Printer (Media Type)
 - Paper Settings on the Printer Driver and the Printer (Paper Size)
 - Setting the Number of Copies and Printing Order
 - Setting the Stapling Margin
 - Execute Borderless Printing
 - Scaling the Printing to Fit the Paper Size
 - Scaled Printing
 - Page Layout Printing
 - Printing on Postcards
 - Changing the Clear Coating Settings
 - Switching the Paper Source to Match the Purpose
 - Setting Paper Dimensions (Custom Size)
 - Changing the Print Quality and Correcting Image Data
 - Setting the Print Quality Level (Custom)
 - Printing a Color Document in Monochrome
 - Adjusting Tone
 - Specifying Color Correction
 - Optimal Photo Printing of Image Data
 - Adjusting Colors with the Printer Driver
 - Printing with ICC Profiles (Specifying an ICC Profile from the Application Software)
 - Printing with ICC Profiles (Specifying an ICC Profile from the Printer Driver)
 - Interpreting the ICC Profile
 - Adjusting Color Balance
 - Adjusting Brightness
 - Adjusting Contrast
- **Printing Using a Web Service**

- Using PIXMA/MAXIFY Cloud Link
- Printing with Google Cloud Print
 - Getting Google Account
 - Registering Printer with Google Cloud Print
 - Printing from Computer or Smartphone with Google Cloud Print
 - Deleting Printer from Google Cloud Print
- Easy-PhotoPrint+ Guide
- **Printing from an AirPrint-enabled Printer with Mac**
- **Printing from Smartphone/Tablet**
 - Printing Directly from Smartphone/Tablet
 - Android Print
 - Printing from an AirPrint-enabled Printer with iOS Device
 - Using Printer with Direct Connection
 - Printing Using a Web Service
 - Using PIXMA/MAXIFY Cloud Link
 - Printing with Google Cloud Print
- **Printing Using Operation Panel**
 - Printing Templates Such as Lined or Graph Paper
- **Printing from Digital Camera**
 - Printing Photographs Directly from PictBridge (Wireless LAN) Compliant Device
 - PictBridge (Wireless LAN) Print Settings

Printing from Computer

▶ Printing from Application Software (Windows Printer Driver)

- Printing with Easy Setup 📄 **Basics**
- Setting a Page Size and Orientation
- Setting the Number of Copies and Printing Order
- Setting the Stapling Margin
- Execute Borderless Printing
- Fit-to-Page Printing
- Scaled Printing
- Page Layout Printing
- Tiling/Poster Printing
- Booklet Printing
- Duplex Printing
- Stamp/Background Printing
- Registering a Stamp
- Registering Image Data to be Used as a Background
- Printing on Postcards
- Changing the Clear Coating Settings
- Switching the Paper Source to Match the Purpose
- Displaying the Print Results before Printing
- Setting Paper Dimensions (Custom Size)
- Editing the Print Document or Reprinting from the Print History
- Changing the Print Quality and Correcting Image Data

▶ Printing from Application Software (Mac OS Printer Driver)

- Printing with Easy Setup 📄 **Basics**
- Setting the Number of Copies and Printing Order
- Setting the Stapling Margin
- Execute Borderless Printing

- [Scaling the Printing to Fit the Paper Size](#)
- [Scaled Printing](#)
- [Page Layout Printing](#)
- [Printing on Postcards](#)
- [Changing the Clear Coating Settings](#)
- [Switching the Paper Source to Match the Purpose](#)
- [Setting Paper Dimensions \(Custom Size\)](#)
- [Changing the Print Quality and Correcting Image Data](#)

▶ **Printing Using a Web Service**

- [Using PIXMA/MAXIFY Cloud Link](#)
- [Printing with Google Cloud Print](#)
- [Easy-PhotoPrint+ Guide](#)

Printing from Application Software (Mac OS Printer Driver)

- ▶ **Printing with Easy Setup**  **Basic**
- ▶ **Setting the Number of Copies and Printing Order**
- ▶ **Setting the Stapling Margin**
- ▶ **Execute Borderless Printing**
- ▶ **Scaling the Printing to Fit the Paper Size**
- ▶ **Scaled Printing**
- ▶ **Page Layout Printing**
- ▶ **Printing on Postcards**
- ▶ **Switching the Paper Source to Match the Purpose**
- ▶ **Setting Paper Dimensions (Custom Size)**
- ▶ **Changing the Print Quality and Correcting Image Data**

Printing with Easy Setup

The simple setup procedure for carrying out appropriate printing on this printer is as follows:

1. [Check that the printer is turned on](#)
2. [Load paper](#) on the printer
3. Select the printer

Select your model from the **Printer** list in the [Print Dialog](#).

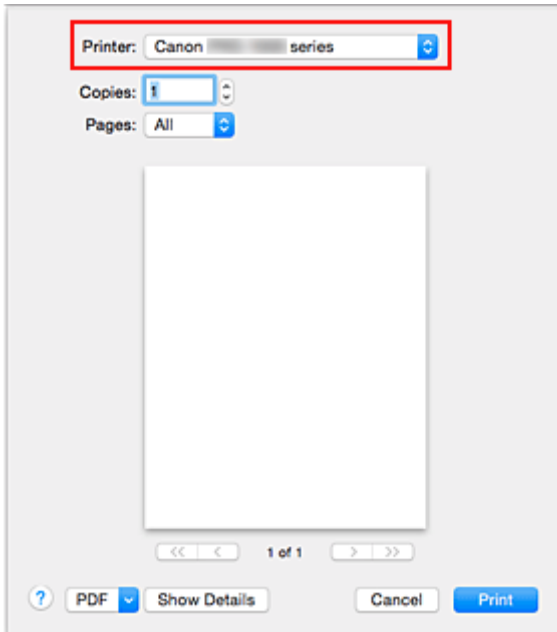

►►► Note

- Click **Show Details** to switch the Setup window to the detailed display.

4. Select the paper size

For **Paper Size**, select the paper size to be used.

If necessary, set the number of copies, the pages to be printed, and the orientation.

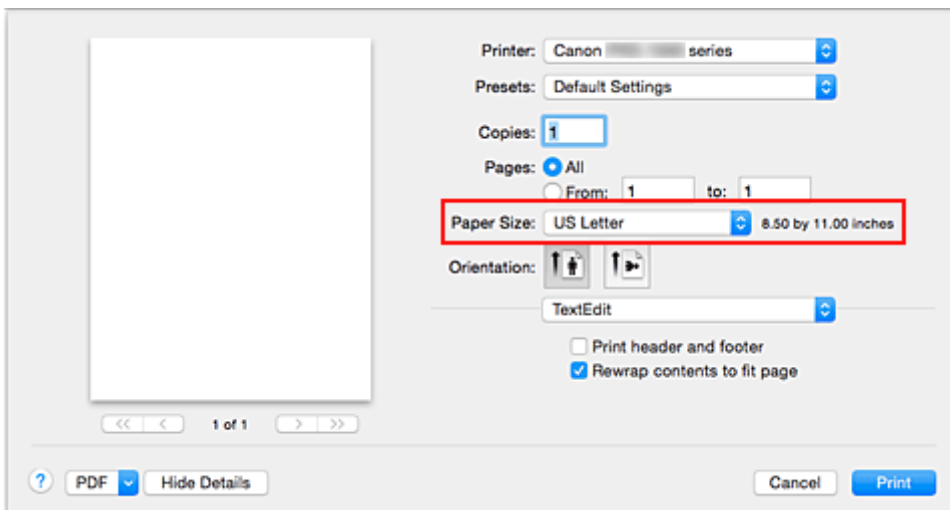

5. Select **Quality & Media** from the pop-up menu

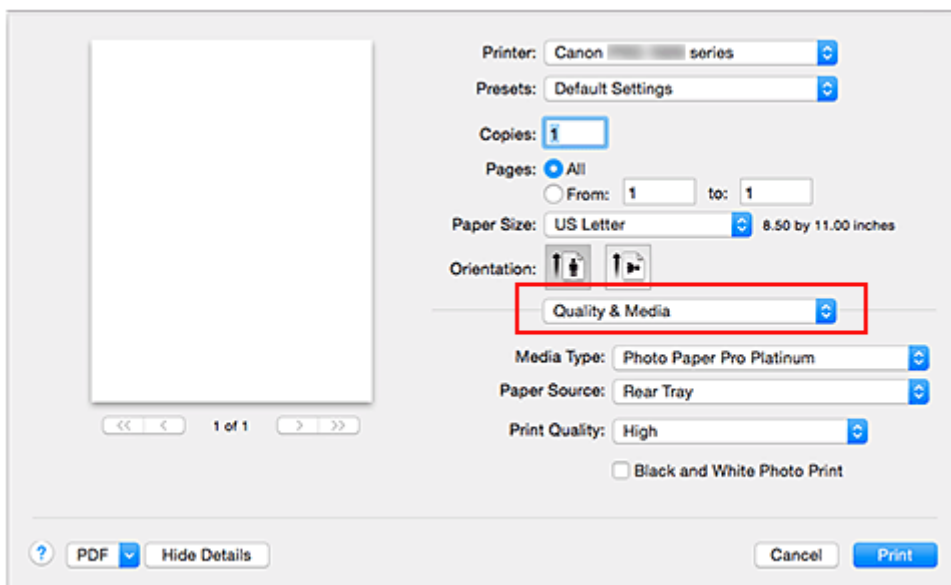

6. Select the media type

For **Media Type**, select the same paper type loaded in the printer.

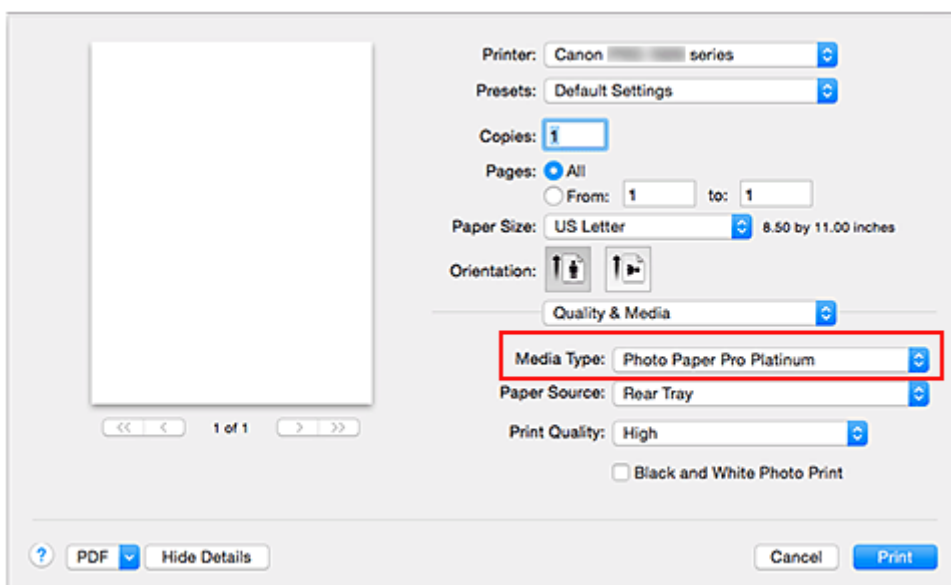

7. Select the paper source

Select **Manual Feed** or **Rear Tray** that matches your purpose for **Paper Source**.

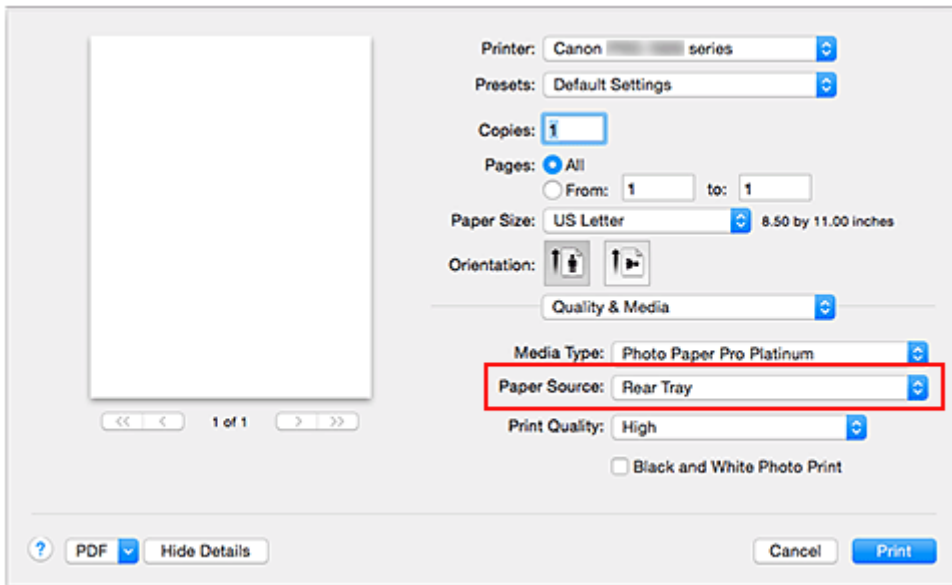

»»» Important

- The paper source settings that can be selected may differ depending on the paper type and size.

8. Select the print quality

For **Print Quality**, select **Highest**, **High** or **Standard** according to your purpose.

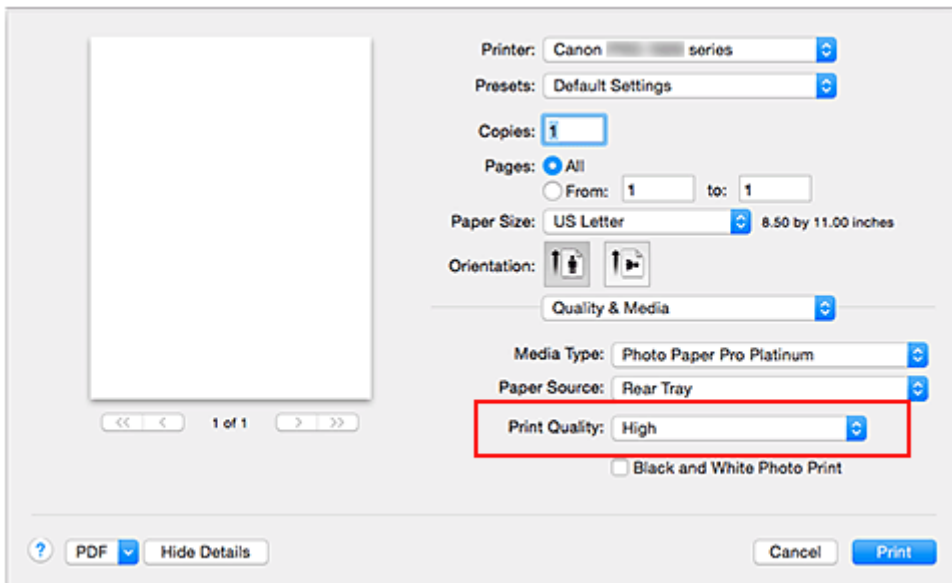

»»» Important

- The print quality settings that can be selected may differ depending on a printing profile.

9. Complete the setup

Click **Print**.

When you execute print, the document will be printed in accordance with the type and size of the media.

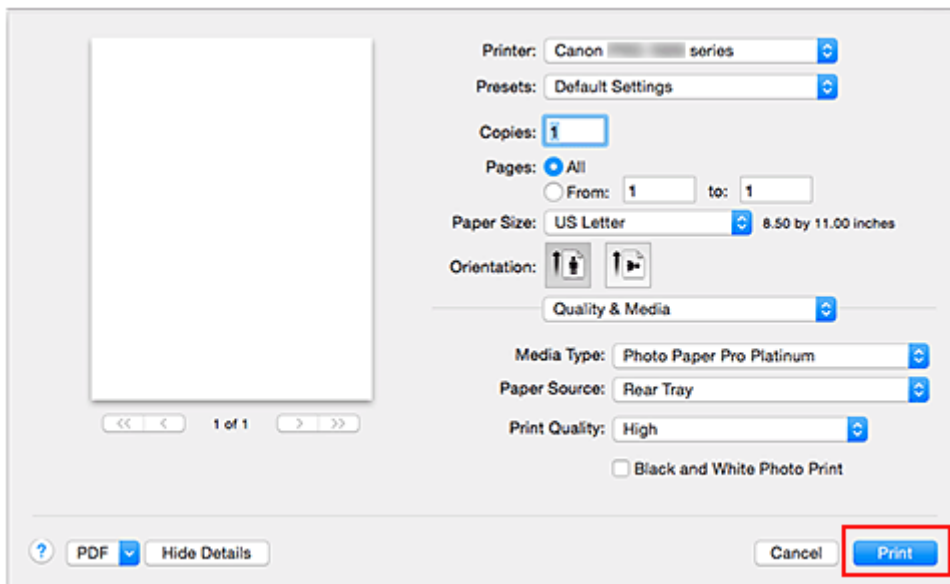

►► Important

- In the **Presets** section, click **Save Current Settings as Preset...** to [register the specified settings](#).
- To print by using the manual feed tray, perform the operation according to the instructions displayed on the screen.

►► Note

- If the paper settings on the print dialog differ from the rear tray paper information registered on the printer, an error may occur. For instructions on what to do if an error occurs, see "[Paper Settings](#)." For details about the rear tray paper information to be registered on the printer, see the following:
 - [Paper Settings on the Printer Driver and the Printer \(Media Type\)](#)
 - [Paper Settings on the Printer Driver and the Printer \(Paper Size\)](#)
- When you set **Media Type** to **Photo Paper Pro Premium Matte** or **Matte Photo Paper** from the **Quality & Media** pop-up menu of the print dialog, we recommend that you set Paper Size to **4 x 6, L**, or "XXX (Margin 25)" in the print dialog. When a page size other than "XXX (Margin 25)" is selected, an error message may appear. Select "XXX (Margin 25)", or change the [Cancel Margin Regulation](#) for paper size setting from the **Paper Detailed Settings** pop-up menu of the print dialog.

Paper Settings on the Printer Driver and the Printer (Media Type)

When you use this printer, selecting a media type and [paper size](#) that matches the print purpose will help you achieve the best print results.

Depending on the media type you are using, specify the media type settings on the printer's operation panel or the printer driver as described below.

▶▶▶ Note

- When you use the manual feed tray, you do not need to set media information on the printer.

Canon genuine papers (Document Printing)

Media name <Model No.>	Media Type in the printer driver	Paper information registered on the printer
Canon Red Label Superior <WOP111>	Plain Paper	Plain paper
Canon Océ Office Colour Paper <SAT213>	Plain Paper	Plain paper

Canon genuine papers (Photo Printing)

Media name <Model No.>	Media Type in the printer driver	Paper information registered on the printer
Photo Paper Plus Glossy II <PP-201>	Photo Paper Plus Glossy II	Plus Glossy II
Photo Paper Pro Platinum <PT-101>	Photo Paper Pro Platinum	Pro Platinum
Photo Paper Pro Luster <LU-101>	Photo Paper Pro Luster	Pro Luster
Photo Paper Plus Semi-gloss <SG-201>	Photo Paper Plus Semi-gloss	Plus Semi-gloss
Matte Photo Paper <MP-101>	Matte Photo Paper	Matte
Photo Paper Pro Premium Matte <PM-101>	Photo Paper Pro Premium Matte	—

Canon genuine papers (Original Products)

Media name <Model No.>	Media Type in the printer driver	Paper information registered on the printer
Photo Stickers <PS-101>	Photo Paper Plus Glossy II	Plus Glossy II

Non-genuine Canon paper

When you use non-genuine Canon paper, you can print easily by using the existing settings that have been prepared on the printer's operation panel and in the printer driver.

Media name <Model No.>	Media Type in the printer driver	Paper information registered on the printer
Plain Paper (including recycled paper)	Plain Paper	Plain Paper
Photo Paper (Approximately 0.1mm to less than 0.3mm)	Lightweight Photo Paper *2	Light Photo Paper

Photo Paper (Approximately 0.3mm to less than 0.6mm)	Heavyweight Photo Paper *2	—
Art Paper (Approximately 0.1mm to less than 0.3mm)	Heavyweight Fine Art Paper *2	Heavy Art Paper
Art Paper (Approximately 0.3mm to less than 0.6mm)	Extra Heavyweight Fine Art Paper *2	—
Art Paper *1	Highest Density Fine Art Paper	—
Fabric that has the look of canvas	Canvas *2	Canvas
Japanese Paper Washi	Japanese Paper Washi *2	Japanese Paper

*1 Use the **Highest Density Fine Art Paper** setting when using a type of Fine Art Paper that is particularly thick and will absorb more ink than others. More ink is used than in regular printing and therefore depending on the type of paper, it can increase the depth of color. However, depending on the type of paper used, the ink can bleed into the paper, causing the paper to rub and get dirty, or damage the print heads.

*2 To improve the print quality and paper feeding when using paper other than Canon genuine paper, create a custom paper by using Media Configuration Tool and add it to the printer. These media types can be used as custom paper standards.

▶▶▶ Note

- If you have added a new media type using the Media Configuration Tool, open the Canon IJ Printer Utility², and from **Media Information**, select **Update Media Information (Correct Media Information)** and carry out a driver media information update.
When printing on a newly added media type, change both the media settings on the printer driver and the registered media information on the printer to those of the new media.
- When you set **Media Type** to **Photo Paper Pro Premium Matte** or **Matte Photo Paper** from the **Quality & Media** pop-up menu of the print dialog, we recommend that you set **Paper Size** to **4 x 6, L**, or "XXX (Margin 25)" in the print dialog.
For information about printable ranges, refer to "[Printing Area](#)."

Paper Settings on the Printer Driver and the Printer (Paper Size)

When you use this printer, selecting a paper size that matches the print purpose will help you achieve the best print results.

You can use the following paper sizes on this printer.

Paper Size in the printer driver	Paper information registered on the printer
US Letter	Letter
Letter (Margin 25)	Letter
US Legal	Legal
A5	A5
A4	A4
A4 (Margin 25)	A4
A3	A3
A3 (Margin 25)	A3
A3+ 13"x19" 33x48cm	A3+
A3+ (Margin 25)	A3+
A2	A2
A2 (Margin 25)	A2
JIS B5	B5
JIS B4	B4
JIS B3	B3
4 x 6	KG/4"x6"(10x15cm)
5 x 7	2L(127x178mm)/5"x7"(13x18cm)
Tabloid	11"x17" 28x43cm
Tabloid (Margin 25)	11"x17" 28x43cm
C	17"x22" 43x56cm
C (Margin 25)	17"x22" 43x56cm
8 x 10	8"x10"(20x25cm)
10"x12" 25x30cm	10"x12"(25x30cm)
14"x17" 36x43cm	14"x17"(36x43cm)
L	L(89x127mm)
Custom Size	Others

Setting the Number of Copies and Printing Order

Collate pages + Reverse Collate pages + Normal Reverse

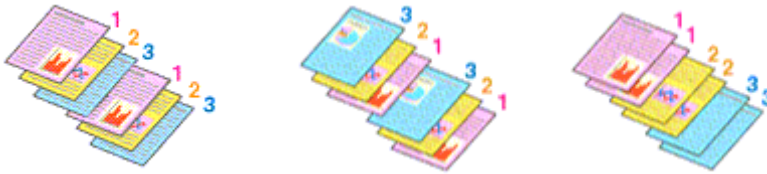

The procedure for specifying the number of copies and printing order is as follows:

1. Specify the number of copies to be printed

Specify the number of copies to print from the **Copies** in the [Print Dialog](#).

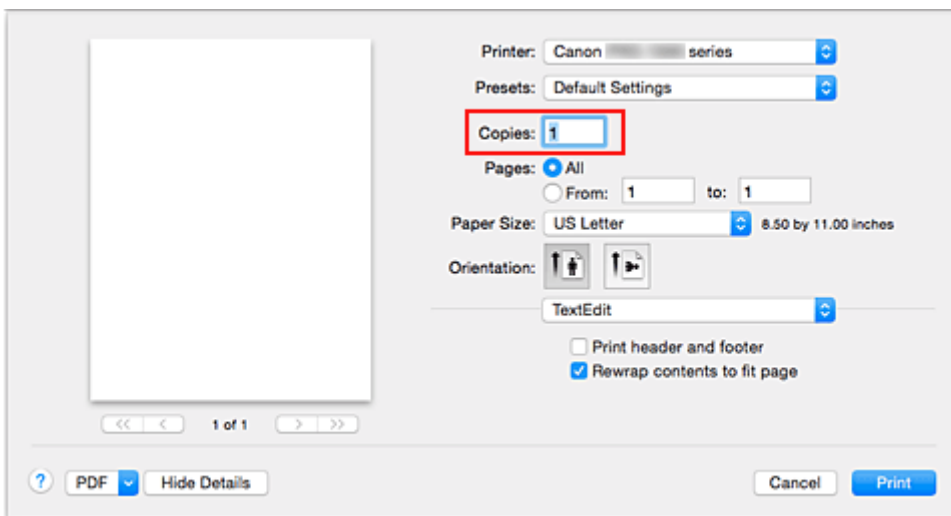

2. Select **Paper Handling** from the pop-up menu
3. Check the **Collate pages** check box when you are specifying multiple copies in the **Copies** box

Check the **Collate pages** check box to print all the pages of a single copy together. Uncheck this check box to print all pages with the same page number together.

4. Specify the print order

Check **Page Order**.

When you select **Automatic** or **Reverse**, printing starts from the last page.

When you select **Normal**, printing starts from the first page.

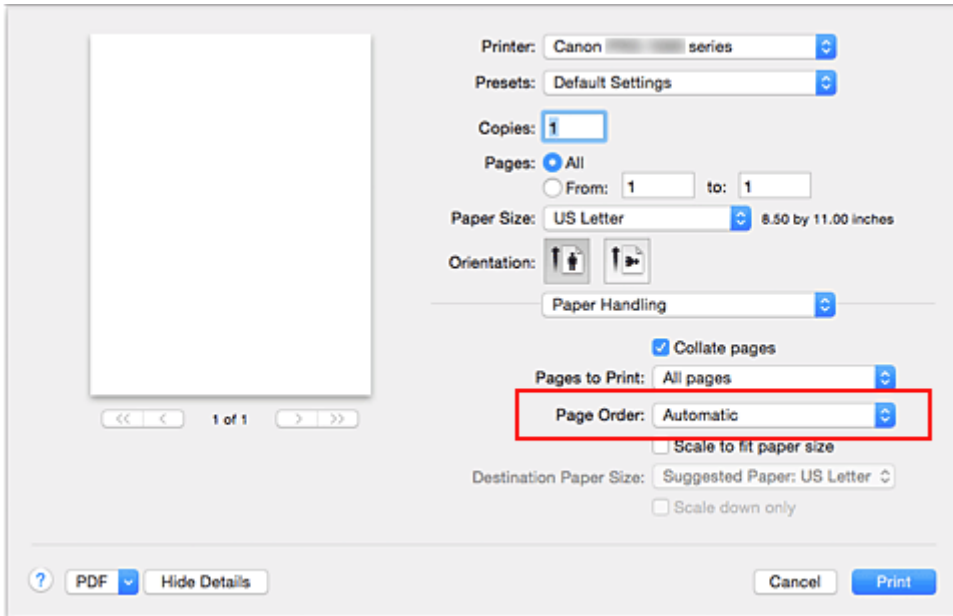

5. Complete the setup

Click **Print**.

When you execute print, the specified number of copies will be printed with the specified printing order.

▶▶▶ Important

- When the application software that you used to create the document has the same function, specify the settings on the printer driver. However, if the print results are not acceptable, specify the function settings on the application software. When you specify the number of copies and the printing order with both the application software and this printer driver, the number of copies may be multiplied numbers of the two settings or the specified printing order may not be enabled.

Setting the Stapling Margin



The procedure for setting the margin width and the staple side is as follows:

1. Select **Page Processing** from the pop-up menu on the [Print Dialog](#)

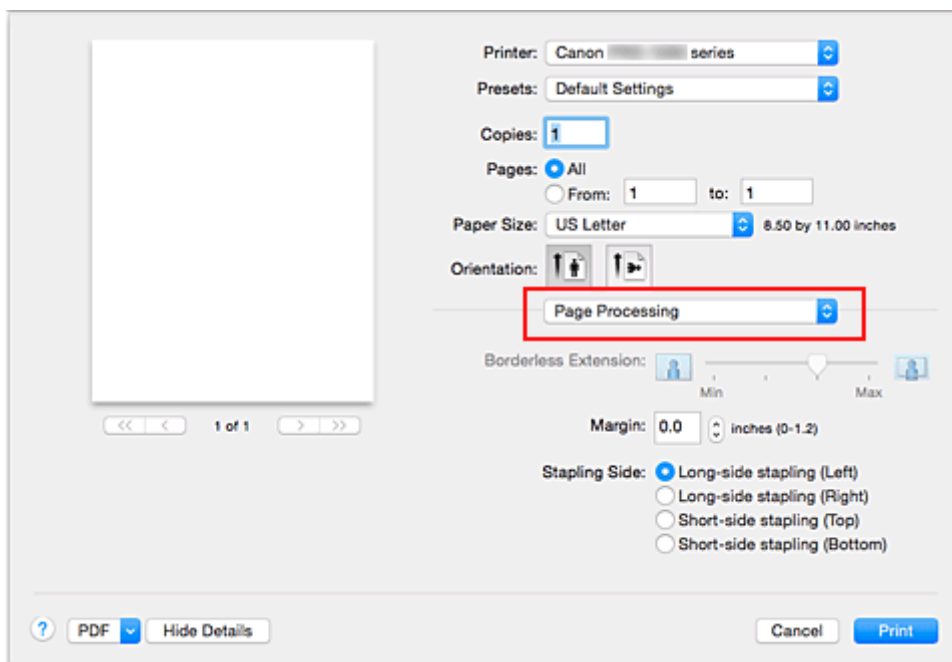

2. Set the margin width and the staple side

If necessary, set the **Margin** width, and select a stapling position from the **Stapling Side** list.

▶▶▶ Note

- The printer automatically reduces the print area depending on the staple position margin.

3. Complete the setup

Click **Print**.

When you execute print, the data is printed with the specified margin width and staple side.

▶▶▶ Important

- When borderless printing is enabled, **Margin** and **Stapling Side** appear grayed out and are unavailable.

Execute Borderless Printing

The borderless printing function allows you to print data without any margin by enlarging the data so that it extends slightly off the paper. In standard printing, margins are created around the document area. However, in borderless printing function, these margins are not created. When you want to print data such as a photo without providing any margin around it, set borderless printing.

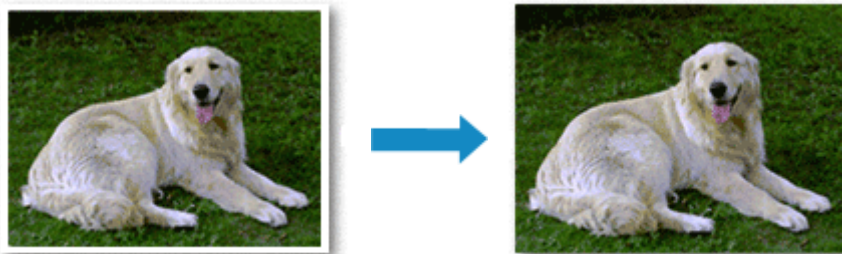

The procedure for performing borderless printing is as follows:

Setting Borderless Printing

1. Select the size of the paper for borderless printing

Select "XXX (borderless)" from the **Paper Size** in the [Print Dialog](#).

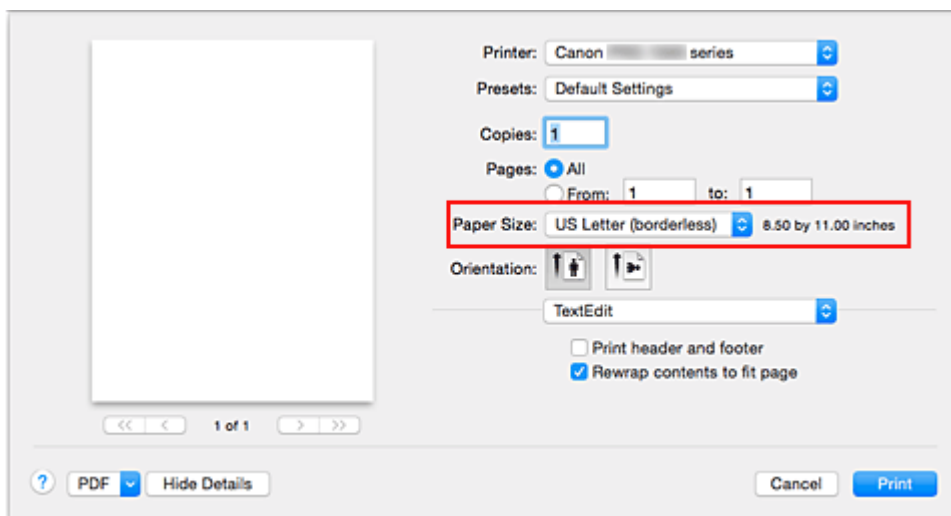

2. Select **Page Processing** from the pop-up menu

3. Adjust the amount of extension from the paper

If necessary, adjust the amount of extension using the **Borderless Extension** slider.

Moving the slider to the right increases the amount extending off the paper, and moving the slider to the left decreases the amount.

It is recommended to set the slider at the second position from the right for most cases.

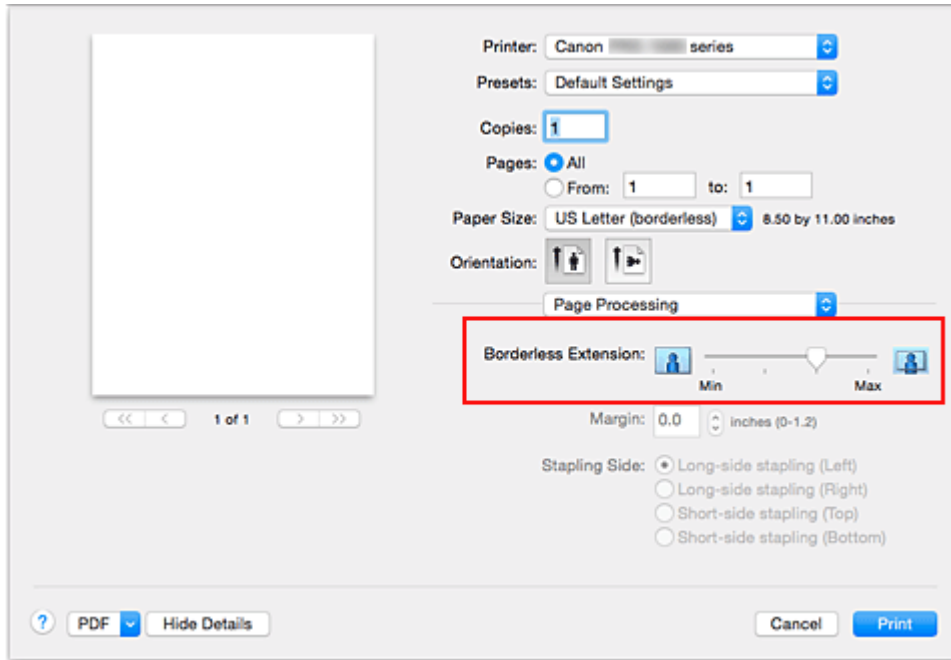

►►► Important

- When the **Borderless Extension** slider is set to the rightmost position, the back side of the paper may become smudged.

4. Complete the setup

Click **Print**.

When you execute print, the data is printed without any margins on the paper.

►►► Important

- Borderless printing only supports specific paper sizes. Make sure to select a paper size with the wording "(borderless)" from the **Paper Size**.
- When borderless printing is enabled, **Plain Paper**, **Hagaki**, and **Hagaki (A)** appear grayed out and are unavailable in **Media Type** list of **Quality & Media** of the pop-up menu in the Print dialog.
- Depending on the type of paper, Borderless Printing may reduce the print quality at the top and bottom edges of the paper. Borderless Printing on thick paper may also smudge the front or back surface of the paper.
- When the ratio of the height to the width differs from the image data, a portion of the image may not be printed depending on the size of the media used.
In this case, crop the image data with an application software according to the paper size.
- When scaled printing or page layout printing is enabled, you cannot perform borderless printing.

►►► Note

- When you set **Media Type** to **Photo Paper Pro Premium Matte** or **Matte Photo Paper** from the **Quality & Media** pop-up menu of the print dialog, borderless full-page printing is not recommended.

Expanding the Range of the Document to Print

Setting a large amount of extension allows you to perform borderless printing with no problems. However, the portion of the document extending off the paper range will not be printed and for this reason, the subjects around the perimeter of a photo may not be printed.

When you are not satisfied with the result of borderless printing, reduce the amount of extension. The extension amount decreases as the **Borderless Extension** slider is moved to the left.

▶▶ Important

- When the amount of extension is decreased, an unexpected margin may be produced on the print, depending on the size of the paper.

▶▶ Note

- When the **Borderless Extension** slider is set to the leftmost position, image data will be printed in the full size. If you set this when printing the address side of a postcard, the postal code of the sender is printed in the correct position.

Scaling the Printing to Fit the Paper Size



The procedure for printing a document that is automatically enlarged or reduced to fit the page size to be used is as follows:

1. Check the paper size

Check that the **Paper Size** in the [Print Dialog](#) is the same as the paper size that you set in the application software.

2. Select **Paper Handling** from the pop-up menu

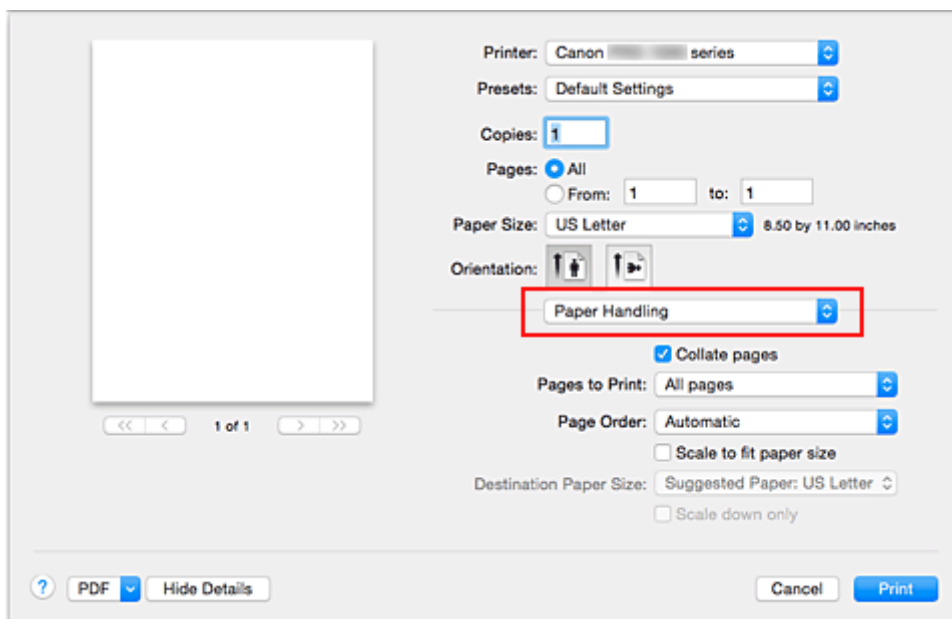

3. Set the print paper size

Check the **Scale to fit paper size** check box. Then from the **Destination Paper Size** pop-up menu, select the paper size that is actually loaded in the printer.

4. If necessary, check the **Scale down only** check box

When you check this check box, the document will be reduced to fit to the paper size when the document size is larger than the page size. The document will be printed in the original size when the document size is smaller than the page size.

5. Complete the setup

Click **Print**.

When you execute print, the document will be enlarged or reduced to fit to the page size.

Scaled Printing

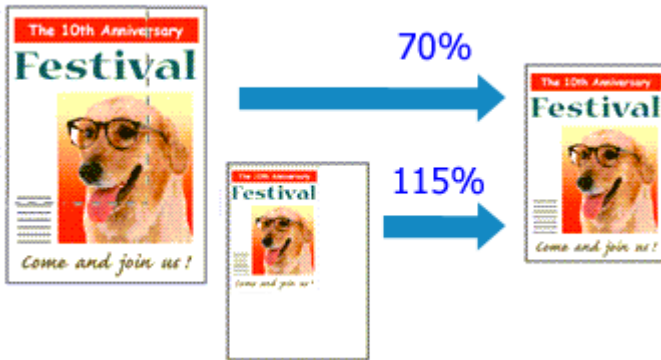

The procedure for printing a document with pages enlarged or reduced is as follows:

1. Select the printer

In the [Page Setup Dialog](#), select your model name from the **Format For** list.

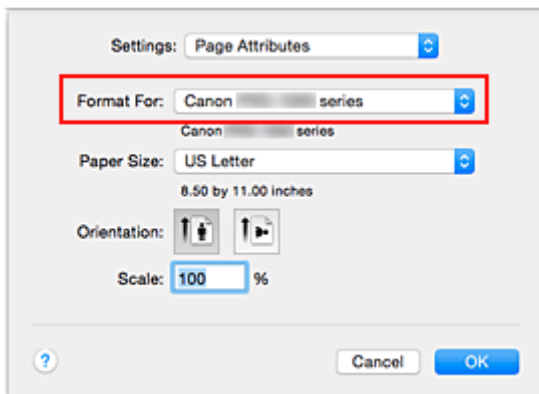

2. Set scaled printing

Specify the scaling factor in the **Scale** box, and click **OK**.

▶▶▶ Note

- Depending on the **Scale** value that you set, an error message may be displayed.

3. Complete the setup

On the [Print Dialog](#), click **Print**.

When you execute print, the document will be printed with the specified scale.

▶▶▶ Important

- When the application software which you used to create the original has the scaled printing function, configure the settings on your application software. You do not need to configure the same setting in the Page Setup dialog.

Page Layout Printing

The page layout printing function allows you to print more than one page image on a single sheet of paper.



The procedure for performing page layout printing is as follows:

1. Select **Layout** from the pop-up menu in the [Print Dialog](#)

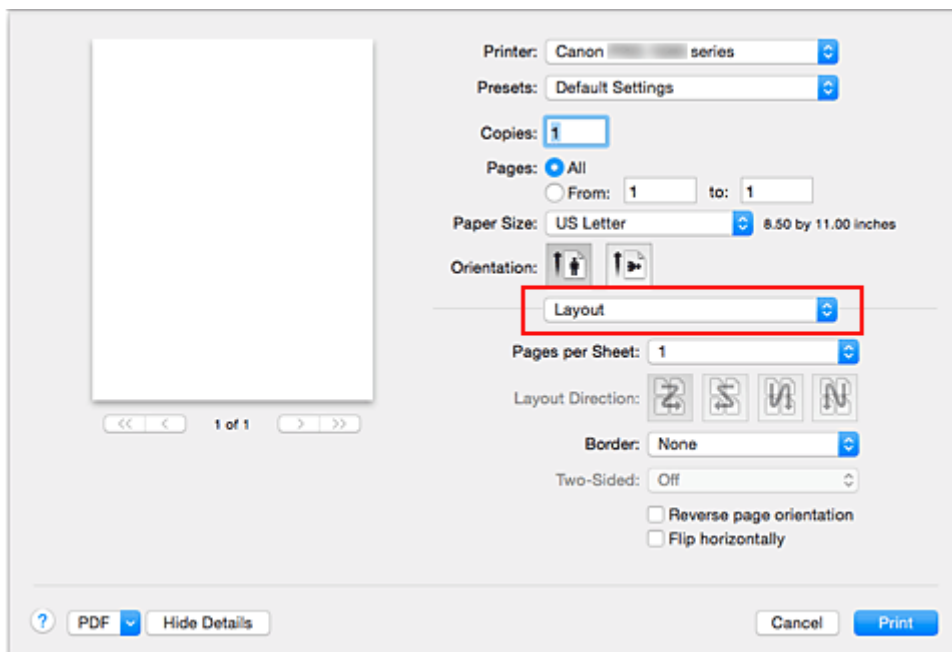

2. Set the number of original you print on one page

In **Pages per Sheet**, specify the number of page you print on one page.

3. If necessary, set the following items

Layout Direction

To change the page placement order, select an icon from the list.

Border

To print a page border around each document page, select a type of page border.

Reverse page orientation

Select this check box to change the paper orientation.

Flip horizontally

Select this check box to reverse left and right of the document.

4. Complete the setup

Click **Print**.

When you execute print, the specified number of pages will be arranged on each sheet of paper in the specified order.

Printing on Postcards

This section describes the procedure for postcard printing.

1. [Load postcard](#) on the printer
2. Select paper size in the [Print Dialog](#)

Select **Postcard** or **Postcard Double** from the **Paper Size** menu.

»» Important

- Return postcards can be used only when you print them from the computer.
- When printing a return postcard, always set the paper size to **Postcard Double** from your application software or the printer driver.
- Do not fold the return postcard. If a crease is formed, the printer will not be able to feed the postcard properly, and this condition will cause line shifts or a paper jam.
- With return postcards, borderless printing cannot be used.

3. Select **Quality & Media** from the pop-up menu
4. Select the media type

For **Media Type**, select the same paper type loaded in the printer.

»» Important

- This printer cannot print on postcards that have photos or stickers attached.
- When printing on each side of a postcard separately, you will get cleaner printing if you print the message side first and then print the address side.
- The paper settings in the print dialog are different, depending on whether you are printing on the address side or the message side. For details about the rear tray paper information to be registered in the print dialog and on the printer, see the following:
 - [Paper Settings on the Printer Driver and the Printer \(Media Type\)](#)
 - [Paper Settings on the Printer Driver and the Printer \(Paper Size\)](#)

5. Complete the setup

Click **Print**.

When you execute printing, the data will be printed onto the postcard.

»» Important

- If you check the **Do not show again** check box when a guide message is displayed before printing starts, this will stop any more guide messages from being displayed.

Changing the Clear Coating Settings

When you execute clear coating, the printer applies chroma optimizer (CO) ink onto the printing surface and allows you to adjust the glossiness.

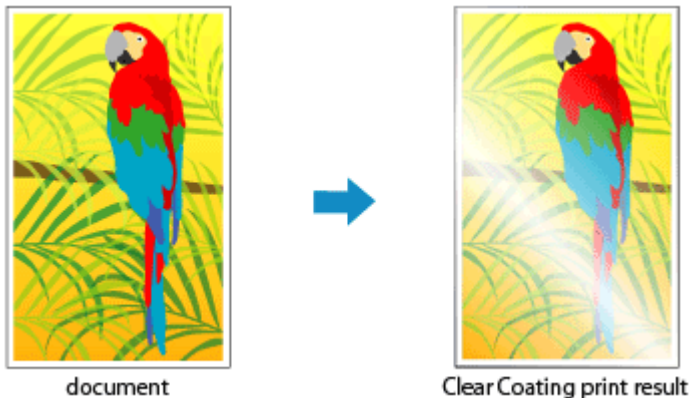

This section explains procedures for changing the clear coating settings.

1. From the [Print Dialog](#), display the pop-up menu, and select **Paper Detailed Settings**
2. Setting the clear coating area

Select **Auto** or **Overall** under **Clear Coating Area**.

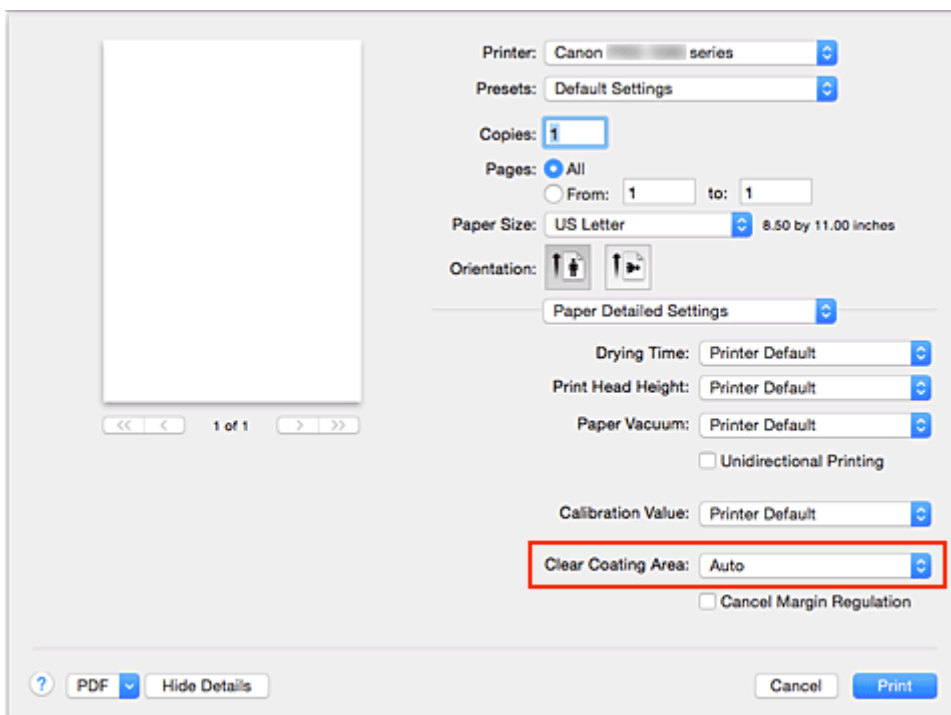

Auto

The printer automatically sets the areas to be clear-coated and whether clear coating is to be executed.

It may be possible to reduce the ink consumption of the chroma optimizer (CO) or to accelerate the print speed.

Overall

The printer clear-coats the entire print area.

If selecting **Auto** produced unsatisfactory clear coating effects, selecting **Overall** may improve the results.

Important

- On the **Quality & Media**, look at **Media Type**. If a media type other than **Photo Paper Plus Glossy II**, **Photo Paper Pro Platinum**, **Photo Paper Pro Luster**, **Photo Paper Plus Semi-gloss**, **Lightweight Photo Paper**, or **Heavyweight Photo Paper** is selected, you cannot select **Overall**.
- If **Overall** is selected and the media type is changed to one that cannot use **Overall**, the clear coating area setting is changed to **Auto**.

3. Complete the setup

Click **Print**.

When printing is executed, the clear coating effect that was set is added when the document is printed.

Switching the Paper Source to Match the Purpose

In this printer, there are two paper sources, a manual feed tray and a rear tray. You can facilitate printing by selecting a paper source setting that matches your media type or purpose.

The procedure for setting paper source is as follows:

1. Select **Quality & Media** from the pop-up menu of the [Print Dialog](#)

2. Select the media type

For **Media Type**, select the same paper type loaded in the printer.

3. Select the paper source

For **Paper Source**, select the item below that matches your purpose.

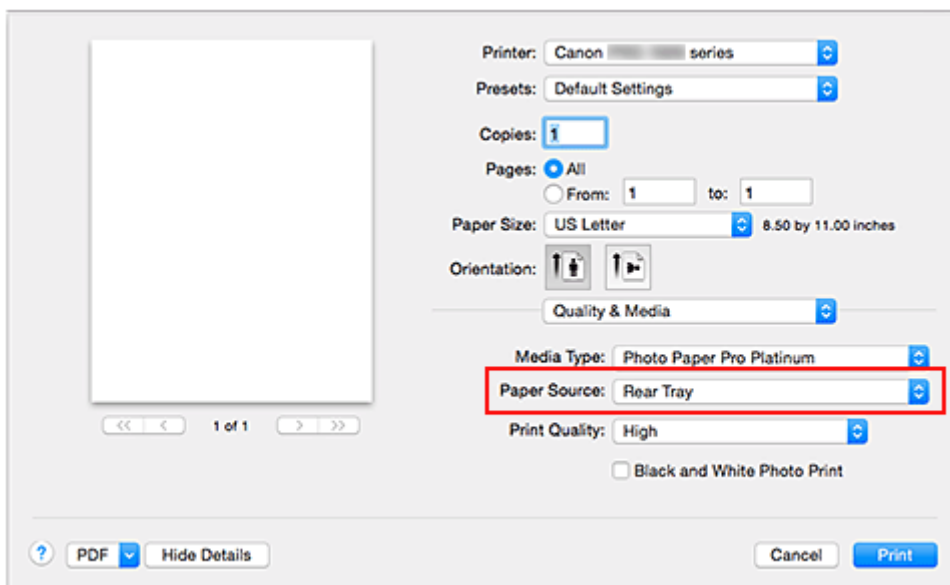

Manual Feed

Paper is supplied from the manual feed tray in the back.

»»» Important

- When **A5, JIS B5, 4 x 6, 5 x 7, L, Postcard, or Postcard Double** is selected for **Paper Size** on the Print Dialog, paper cannot be supplied from the manual feed tray in the back.
- When **Plain Paper, Hagaki (A), Ink Jet Hagaki, or Hagaki** is selected from the **Media Type** menu of the **Quality & Media** on the pop-up menu in the Print dialog, paper cannot be supplied from the manual feed tray in the back.

Rear Tray

Paper is fed from the rear tray.

»»» Important

- When **Photo Paper Pro Premium Matte, Heavyweight Photo Paper, Extra Heavyweight Fine Art Paper, or Highest Density Fine Art Paper** is selected from the **Media Type** menu of the **Quality & Media** on the pop-up menu in the Print dialog, paper cannot be supplied from the rear tray.

4. Complete the setup

Click **Print**.

When you execute print, the printer uses the specified paper source to print the data.

▶▶ Note

- If the paper settings on the print dialog differ from the rear tray paper information registered on the printer, an error may occur. For instructions on what to do if an error occurs, see "[Paper Settings](#)." For details about the rear tray paper information to be registered on the printer, see the following:
 - [Paper Settings on the Printer Driver and the Printer \(Media Type\)](#)
 - [Paper Settings on the Printer Driver and the Printer \(Paper Size\)](#)

Setting Paper Dimensions (Custom Size)

You can specify the height and width of paper when its size cannot be selected from the **Paper Size** menu. Such a paper size is called "custom size."

The procedure for specifying a custom size is as follows:

1. Creating a new custom paper size

In the [Print Dialog](#), select **Manage Custom Sizes...** from **Paper Size**.

In the displayed dialog, click **+**.

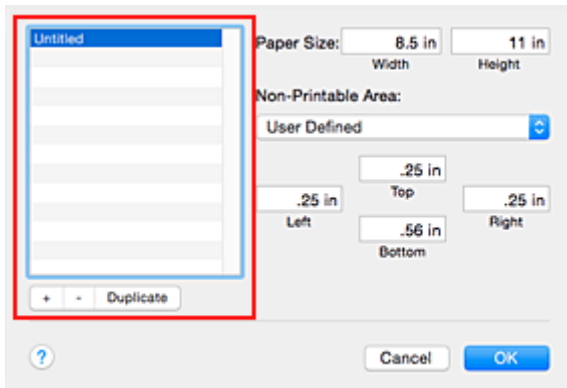

Untitled will be added to the list.

2. Setting details about the custom paper size

Double-click **Untitled**, enter the name of the paper size you want to register, and specify the **Width** and **Height** of the paper for **Paper Size**.

Select **User Defined** or your model for **Non-Printable Area**, and enter the margins.

3. Registering the custom paper size

Click **OK**.

The custom size is registered.

»»» Important

- If the application software that created the document has a function for specifying height and width values, use the application software to set the values. If the application software does not have such a function or if the document does not print correctly, perform the above procedure from the printer driver to set the values.

»»» Note

- To duplicate the registered paper size, select the paper size that you want to duplicate from the **Custom Paper Sizes** list, and click **Duplicate**.
- To delete a registered paper size, select the paper size that you want to delete from the **Custom Paper Sizes** list, and click **-**.
- If the paper settings on the print dialog differ from the rear tray paper information registered on the printer, an error may occur. For instructions on what to do if an error occurs, see "[Paper Settings](#)." For details about the rear tray paper information to be registered on the printer, see the following:
 - [Paper Settings on the Printer Driver and the Printer \(Media Type\)](#)
 - [Paper Settings on the Printer Driver and the Printer \(Paper Size\)](#)

Changing the Print Quality and Correcting Image Data

- ▶ **Setting the Print Quality Level (Custom)**
- ▶ **Printing a Color Document in Monochrome**
- ▶ **Adjusting Tone**
- ▶ **Specifying Color Correction**
- ▶ **Optimal Photo Printing of Image Data**
- ▶ **Adjusting Colors with the Printer Driver**
- ▶ **Printing with ICC Profiles (Specifying an ICC Profile from the Application Software)**
- ▶ **Printing with ICC Profiles (Specifying an ICC Profile from the Printer Driver)**
- ▶ **Interpreting the ICC Profile**
- ▶ **Adjusting Color Balance**
- ▶ **Adjusting Brightness**
- ▶ **Adjusting Contrast**
- ▶ **Changing the Clear Coating Settings**

Setting the Print Quality Level (Custom)

The print quality level can be set in the **Custom**.

The procedure for setting the print quality level is as follows:

1. Select **Quality & Media** from the pop-up menu on the [Print Dialog](#)
2. Select the print quality
Select **Custom** for **Print Quality**.

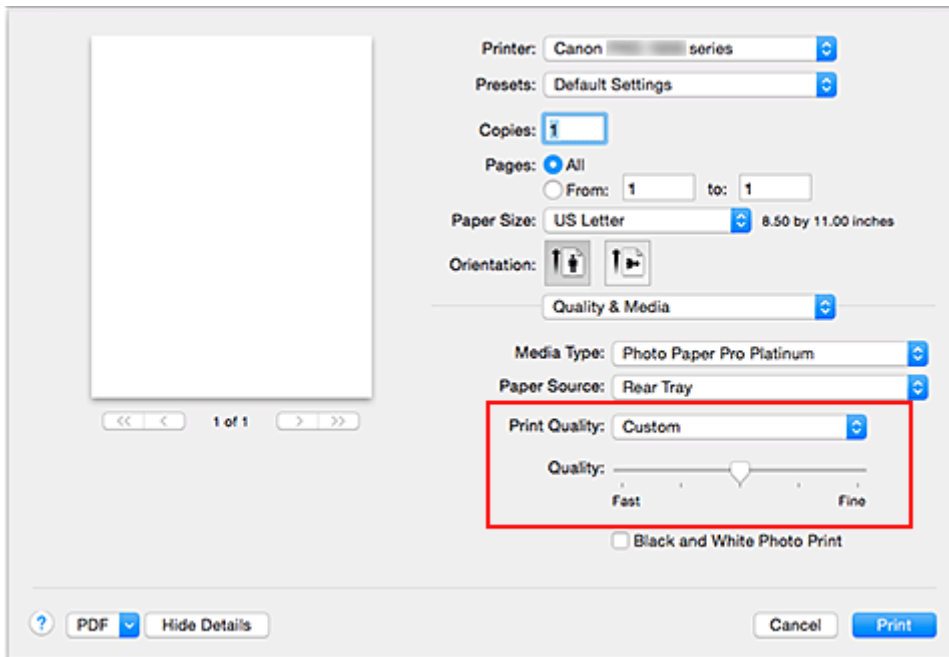

3. Setting the print quality level

Move the **Quality** slider to select the print quality level.

4. Complete the setup

Click **Print**.

When you execute print, the image data is printed with the selected print quality level.

►►► Important

- Certain print quality levels cannot be selected depending on the settings of **Media Type**.

Related Topics

- [Specifying Color Correction](#)
- [Adjusting Color Balance](#)
- [Adjusting Brightness](#)
- [Adjusting Contrast](#)

Printing a Color Document in Monochrome

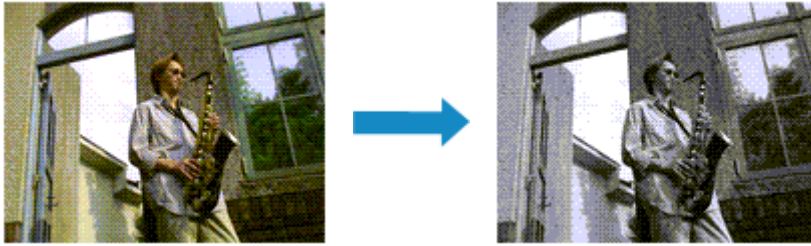

The procedure for printing a color document in monochrome is as follows:

1. Select **Quality & Media** from the pop-up menu on the [Print Dialog](#)
2. Set black and white photo printing

Check the **Black and White Photo Print** check box.

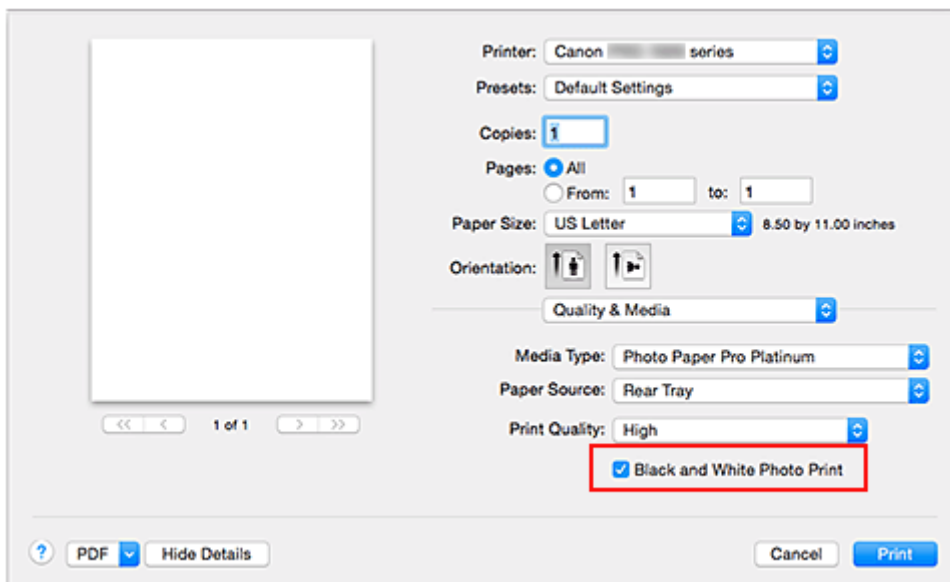

3. Complete the setup

Click **Print**.

When you execute print, the document is converted to grayscale data. It allows you to print the color document in monochrome.

▶▶▶ Note

- During **Black and White Photo Print**, inks other than black ink may be used as well.

Related Topic

- [Adjusting Tone](#)

Adjusting Tone

When printing black and white photos, you can produce the cooling effects of cool colors and the warming effects of warm colors.



Cool Tone is selected **Black and White** is selected **Warm Tone** is selected

The procedure for adjusting tone is as follows:

1. Select **Quality & Media** from the pop-up menu of the [Print Dialog](#)
2. Select the media type

For **Media Type**, select either **Photo Paper Plus Glossy II**, **Photo Paper Pro Platinum**, **Photo Paper Pro Luster**, **Photo Paper Plus Semi-gloss**, **Lightweight Photo Paper**, **Heavyweight Photo Paper**, **Photo Paper Pro Premium Matte**, **Heavyweight Fine Art Paper**, **Extra Heavyweight Fine Art Paper**, **Highest Density Fine Art Paper**, **Canvas**, or **Japanese Paper Washi**.

3. Set black and white photo printing

Check the **Black and White Photo Print** check box.

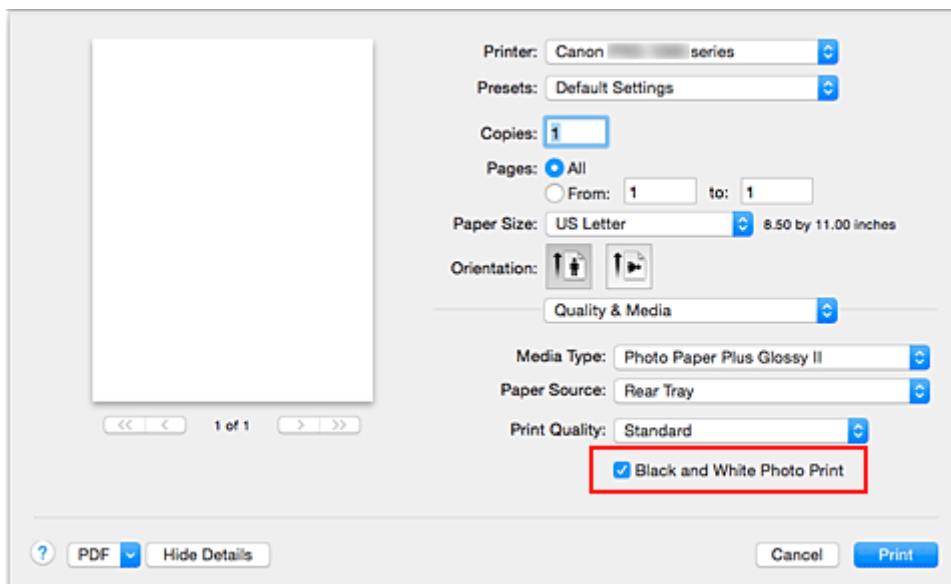

4. Select **Color Options** from the pop-up menu

5. Adjusting monochrome tones

Specify one of the following items from **Tone**. The selected value will be shown in the preview on the left side.

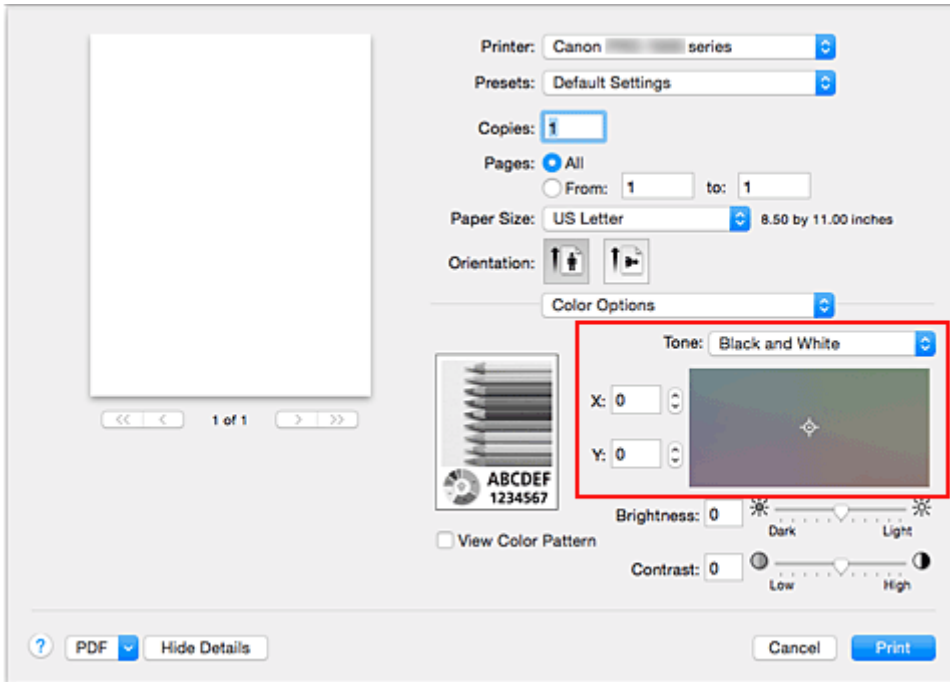

Cool Tone

This item adjusts color tones to cool shades (cool black). When you select **Cool Tone**, a value of -30 is entered for **X**, and a value of 0 for **Y**.

Black and White

This item adjusts color tones to neutral shades. When you select **Black and White**, a value of 0 is entered for **X**, and a value of 0 for **Y**.

Warm Tone

This item adjusts color tones to warm shades (warm black). When you select **Warm Tone**, a value of 30 is entered for **X**, and a value of 0 for **Y**.

Custom

You can adjust the color tones while checking the colors in the adjustment area.

To adjust the color tones, either enter values directly or click the up/down arrows. When you enter values, set values in the range of -100 to 100 for **X**, and -50 to 50 for **Y**.

You can also adjust the color tones by clicking or dragging the adjustment area with the mouse.

If you select another color tone and then select **Custom** again, the values that were preset in **Custom** are restored.

»» Important

- **Tone** and **X, Y** (Monochromatic adjustment value) are displayed when **Black and White Photo Print** check box is selected for **Quality & Media**.

6. If necessary, adjust monochromatic colors manually

To adjust the color tones, either enter values directly to **X** or **Y** (Monochromatic adjustment value) or click the up/down arrows.

You can also adjust the color tones by clicking or dragging the adjustment area with the mouse.

7. Complete the setup

Click **Print**.

When you execute print, the color document is converted to grayscale data with adjusted tones. It allows you to print the color document in monochrome.

»» Important

- If you select **ColorSync** for **Color Matching**, then **Tone**, **X**, and **Y** appear grayed out and are unavailable.

Related Topics

- [Printing a Color Document in Monochrome](#)
- [Adjusting Brightness](#)
- [Adjusting Contrast](#)

Specifying Color Correction

You can specify the color correction method suited to the type of document to be printed. Normally, when data is printed, the printer driver automatically adjusts the colors.

When you want to print by using the color space of the image data effectively or by specifying a printing ICC profile from your application software, select **ColorSync**. When you want to print by having the printer driver correct the colors, select **Canon Color Matching**.

The procedure for specifying color correction is as follows:

1. Select **Color Matching** from the pop-up menu of the [Print Dialog](#)

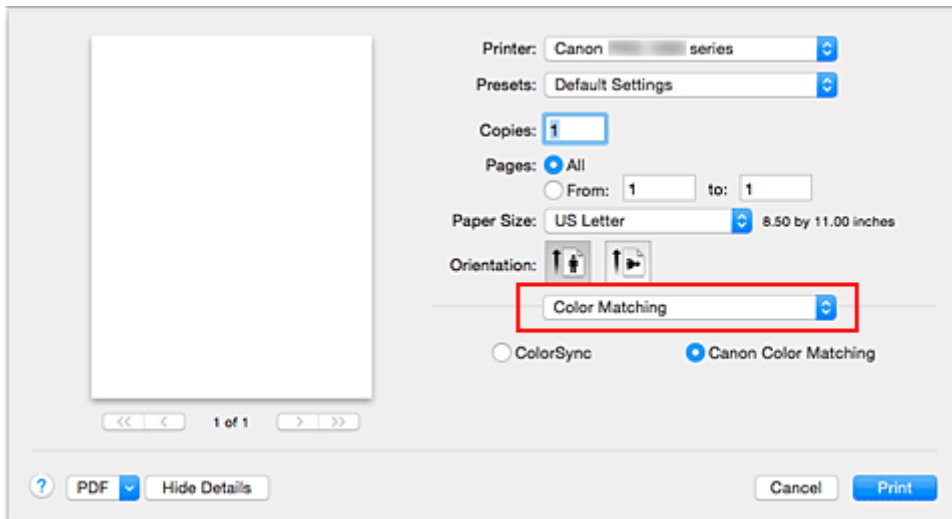

2. Select color correction

Select the item below that matches your purpose.

ColorSync

Perform color correction using ColorSync.

Canon Color Matching

The driver will perform necessary adjustments during printing.

For information about driver matching, see "[Adjusting Colors with the Printer Driver.](#)"

3. Complete the setup

Click **Print**.

When you execute print, the document data is printed with the specified color correction.

Important

- Depending on the application software, when a printing ICC profile is specified from that application software, **Canon Color Matching** cannot be selected because **ColorSync** is selected automatically.
- The **Quality & Media** setting is necessary even when **ColorSync** or **Canon Color Matching** is selected.

Related Topics

- [Optimal Photo Printing of Image Data](#)
- [Adjusting Colors with the Printer Driver](#)
- [Printing with ICC Profiles \(Specifying an ICC Profile from the Application Software\)](#)

- [Printing with ICC Profiles \(Specifying an ICC Profile from the Printer Driver\)](#)
- [Interpreting the ICC Profile](#)

Optimal Photo Printing of Image Data

When people print images taken with digital cameras, they sometimes feel that the printed color tones differ from those of actual image or those displayed on the monitor.

To get the print results as close as possible to the desired color tones, you must select a printing method that is best suited to the application software used or to your purpose.

Color Management

Devices such as digital cameras, scanners, monitors, and printers handle color differently. Color management (color matching) is a method that manages device-dependent "colors" as a common color space.

For Mac OS, a color management system called "ColorSync" is built into the operating system. sRGB is one of the common color spaces that is frequently used.

ICC profiles convert device-dependent "colors" into a common color space. By using an ICC profile and carrying out color management, you can draw out the color space of the image data within the color reproduction area that the printer can express.

▶▶ Note

- Normally, image files are saved in JPEG format. Some digital cameras allow you to save images in a format called RAW. RAW data refers to an image saving format that requires a computer to develop the image. You can embed an input ICC profile tag into a RAW file by using special application software.

Selecting a Printing Method Suited to the Image Data

The recommended printing method depends on the color space of the image data or the application software to be used.

There are two typical printing methods.

Check the color space of the image data and the application software to be used, and then select the printing method suited to your purpose.

[Adjusting Colors with the Printer Driver](#)

Describes the procedure for printing by using the color correction function of the printer driver. Select this function when you want to print impressions that are close to those displayed on the monitor, for example, if you corrected the colors while checking the print image on the monitor.

[Printing with ICC Profiles \(Specifying an ICC Profile from the Application Software\)](#)

Describes the procedure for printing by using the color space of the image data effectively.

You can print with a common color space by setting up the application software and the printer driver so that the color management matches the input ICC profile of the image data.

The method for setting up the printer driver differs depending on the application software to be used.

Related Topic

- [Interpreting the ICC Profile](#)

Adjusting Colors with the Printer Driver

To use driver matching when printing, turn on the printer driver's color correction function. Driver matching accurately applies the characteristics of data displayed on the monitor and allows you to obtain print results of impressions that are close to those displayed on the monitor.

▶▶▶ Important

- When printing using driver matching, Canon recommends that you set the monitor and the environment light as follows:
 - Monitor
 - Color temperature: D50 (5000K)
 - Brightness: 100 to 120cd/m²
 - Gamma: 2.2
 - Environment light
 - Fluorescent light for D50 color evaluation (color temperature 5000K, high color rendering properties)
 - Brightness when looking at printed materials: 500 lx ± 125 lx

▶▶▶ Note

- When printing from an application software that allows you to identify and specify ICC profiles, use an ICC profile for printing with that application software and select setting items that manage colors.

The procedure for adjusting colors with the printer driver is as follows:

1. Select **Color Matching** from the pop-up menu of the [Print Dialog](#)

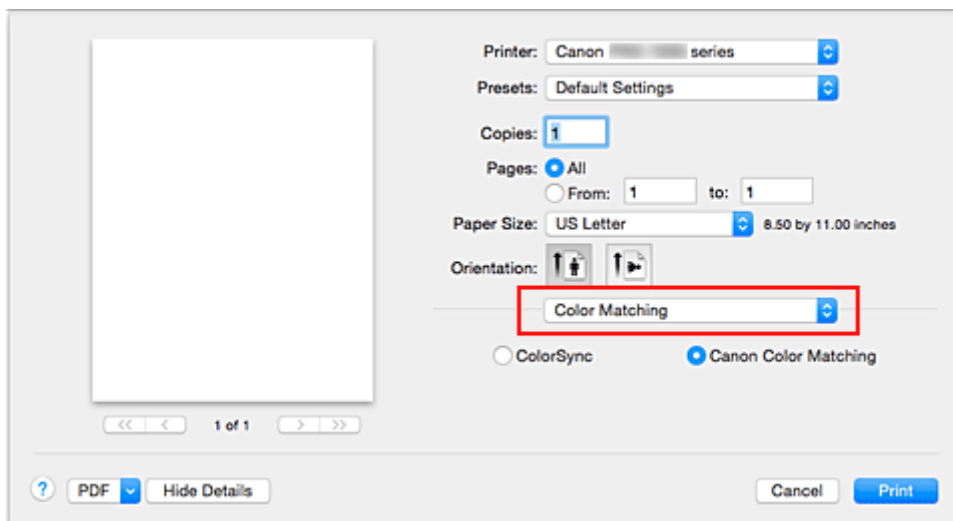

2. Select color correction

Select **Canon Color Matching**.

3. Set the other items

From the pop-up menu, select **Color Options**. If necessary, adjust the color balance (**Cyan**, **Magenta**, **Yellow**) and adjust **Brightness**, and **Contrast** settings.

4. Complete the setup

Click **Print**.

When you execute print, the printer driver adjusts the colors when printing the data.

Related Topics

- [Setting the Print Quality Level \(Custom\)](#)
- [Specifying Color Correction](#)
- [Adjusting Color Balance](#)
- [Adjusting Brightness](#)
- [Adjusting Contrast](#)

Printing with ICC Profiles (Specifying an ICC Profile from the Application Software)

When you print from Adobe Photoshop, Canon Digital Photo Professional, or any application software that can identify input ICC profiles and allows you to specify such profiles, printer uses the color management system (ColorSync) built-into Mac OS when printing. The printer prints the editing and touch-up results of the application software and effectively uses the color space of the input ICC profile specified in the image data.

To use this printing method, use your application software to select color management items and specify an input ICC profile and a printing ICC profile in the image data.

Even if you print using a printing ICC profile that you created yourself or one for special Canon paper, be sure to select color management items from your application software.

For instructions, refer to the manual of the application software you are using.

1. Select **Color Matching** from the pop-up menu of the [Print Dialog](#)

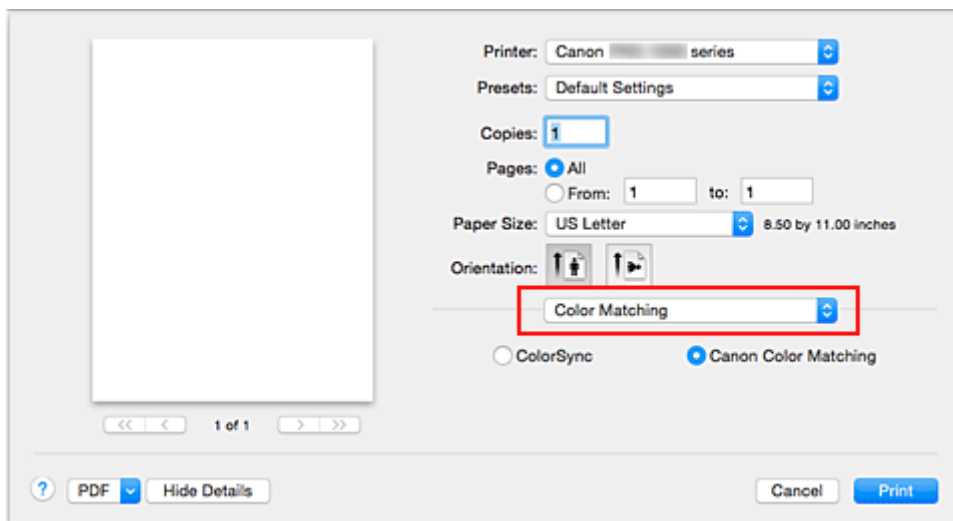

2. Select color correction

Select **ColorSync**.

You can leave **Profile** set to **Automatic**.

Important

- Depending on the application software you use, you may not be able to select setting items other than **ColorSync**.
- If you choose a **Profile** setting other than **Automatic** or "Printing Paper ICC Profile", the printer will not be able to print with the correct colors.

3. Complete the setup

Click **Print**.

When you execute print, the printer uses the color space of the image data.

Related Topics

- [Setting the Print Quality Level \(Custom\)](#)
- [Specifying Color Correction](#)
- [Adjusting Color Balance](#)

■ [Adjusting Brightness](#)

■ [Adjusting Contrast](#)

Printing with ICC Profiles (Specifying an ICC Profile from the Printer Driver)

Print from an application software that cannot identify or specify input ICC profiles by using the color space of the input ICC profile (sRGB) found in the data.

1. Select **Color Matching** from the pop-up menu of the [Print Dialog](#)

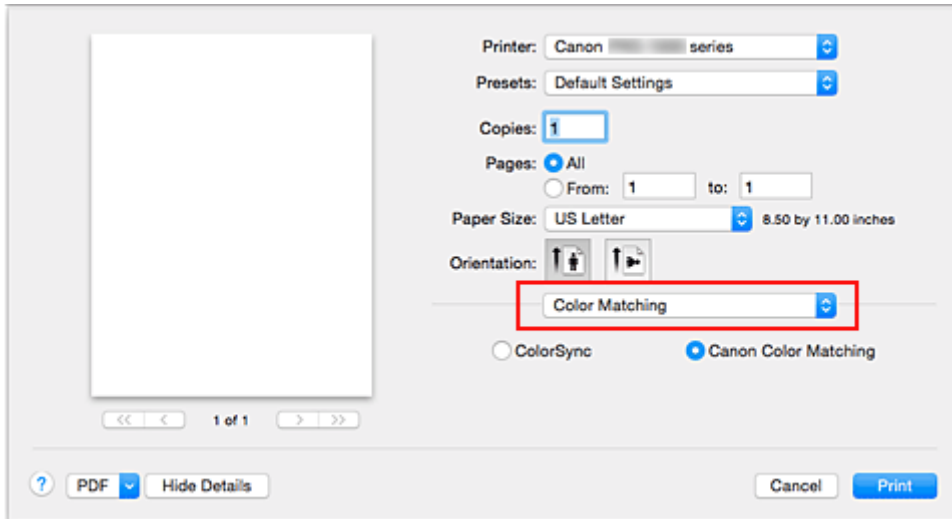

2. Select color correction

Select **ColorSync**.

You can leave **Profile** set to **Automatic**.

▶▶▶ Important

- If you choose a **Profile** setting other than **Automatic** or "Printing Paper ICC Profile", the printer will not be able to print with the correct colors.

3. Complete the setup

Click **Print**.

When you execute print, the printer uses the color space of the image data.

▶▶▶ Important

- You cannot specify an input ICC profile from the printer driver.

Related Topics

- [Setting the Print Quality Level \(Custom\)](#)
- [Specifying Color Correction](#)
- [Adjusting Color Balance](#)
- [Adjusting Brightness](#)
- [Adjusting Contrast](#)

Interpreting the ICC Profile

When you need to specify an ICC profile for this printer, specify the ICC profile of the print output media.

The ICC profiles installed for this printer appear as follows.

Canon XXXXX Photo Paper Plus Glossy II
(1) (2)

- (1) is the model name of the printer.
- (2) is the media type. This media name corresponds to the following media type:

Canvas -P: Canvas

Extra Heavyweight Fine Art Paper -P: Extra Heavyweight Fine Art Paper

Heavyweight Fine Art Paper -P: Heavyweight Fine Art Paper

Heavyweight Photo Paper -P: Heavyweight Photo Paper

High Density Fine Art Paper -P: Highest Density Fine Art Paper

Japanese Paper Washi -P: Japanese Paper Washi

Lightweight Photo Paper -P: Lightweight Photo Paper

Matte Photo Paper -P: Matte Photo Paper

Photo Paper Plus Glossy II : Photo Paper Plus Glossy II

Photo Paper Plus Semi-gloss: Photo Paper Plus Semi-gloss

Photo Paper Pro Luster: Photo Paper Pro Luster

Photo Paper Pro Platinum: Photo Paper Pro Platinum

Photo Paper Pro Premium Matte: Photo Paper Pro Premium Matte

Adjusting Color Balance

You can adjust the color tints when printing.

Since this function adjusts color balance of the output by changing the ink ratios of each color, it changes the total color balance of the document. Use the application software when you want to change the color balance significantly. Use the printer driver only when you want to adjust the color balance slightly.

The following sample shows the case when color balance is used to intensify cyan and to diminish yellow so that the overall colors are more uniform.



No adjustment Adjust color balance

The procedure for adjusting color balance is as follows:

1. Select **Color Options** from the pop-up menu of the [Print Dialog](#)
2. Adjust color balance

There are individual sliders for **Cyan**, **Magenta**, and **Yellow**. Each color becomes stronger when the corresponding slider is moved to the right, and becomes weaker when the corresponding slider is moved to the left. For example, when cyan becomes weaker, the color red becomes stronger.

You can also directly enter a value linked to the slider. Enter a value in the range from -50 to 50. The current settings are displayed in the settings preview on the left side of the printer driver.

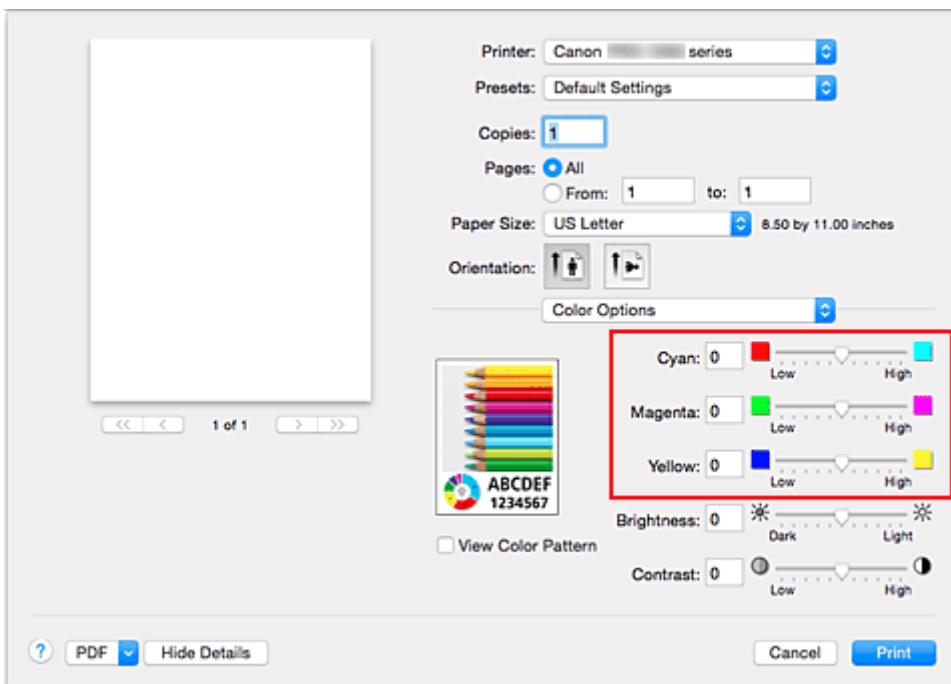

3. Complete the setup

Click **Print**.

When you execute print, the document is printed with the adjusted color balance.

»» Important

- When the **Black and White Photo Print** check box is checked for **Quality & Media**, the color balance (**Cyan, Magenta, Yellow**) are unavailable.
- If you select **ColorSync** for **Color Matching**, then the color balance (**Cyan, Magenta, Yellow**) appear grayed out and are unavailable.

Related Topics

- [Setting the Print Quality Level \(Custom\)](#)
- [Specifying Color Correction](#)
- [Adjusting Brightness](#)
- [Adjusting Contrast](#)

Adjusting Brightness

You can brighten or darken the colors of the overall image data during printing.

The following sample shows the case when light colors are darkened when the image data is printed.



No adjustment



Darken light colors

The procedure for adjusting brightness is as follows:

1. Select **Color Options** from the pop-up menu of the [Print Dialog](#)
2. Adjust brightness

Moving the **Brightness** slider to the right brightens the colors, and moving the slider to the left darkens the colors.

You can also directly enter a value linked to the slider. Enter a value in the range from -50 to 50. The current settings are displayed in the settings preview on the left side of the printer driver.

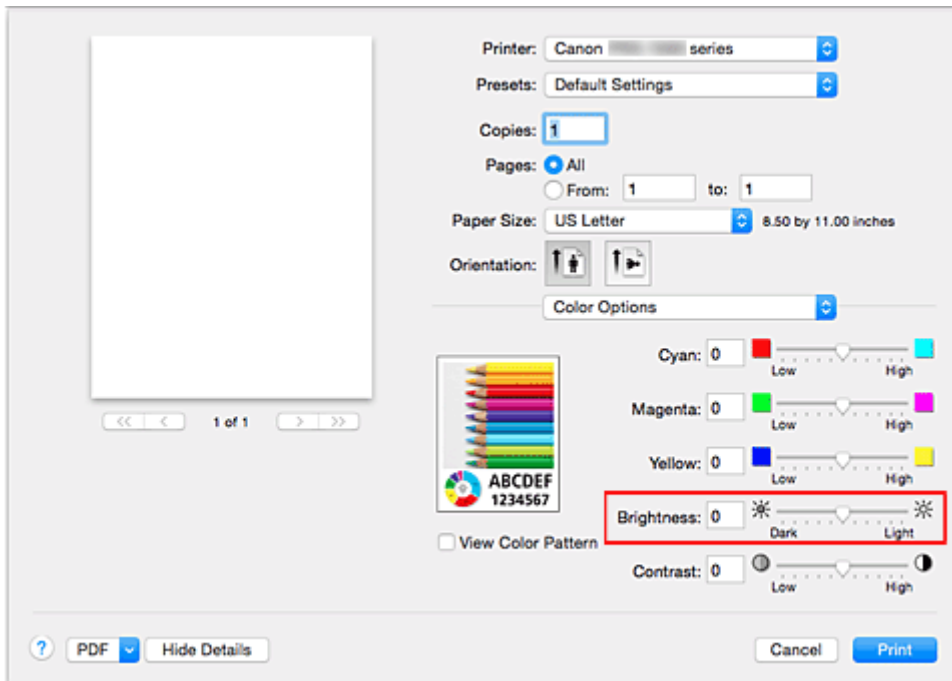

3. Complete the setup

Click **Print**.

When you execute print, the data is printed at the adjusted brightness.

Important

- If you select **ColorSync** for **Color Matching**, then the **Brightness** appears grayed out and is unavailable.

Related Topics

- [Setting the Print Quality Level \(Custom\)](#)
- [Specifying Color Correction](#)
- [Adjusting Color Balance](#)
- [Adjusting Contrast](#)

Adjusting Contrast

You can adjust the image contrast during printing.

To make the differences between the light and dark portions of images greater and more distinct, increase the contrast. On the other hand, to make the differences between the light and dark portions of images smaller and less distinct, reduce the contrast.



No adjustment

Adjust the contrast

The procedure for adjusting contrast is as follows:

1. Select **Color Options** from the pop-up menu of the [Print Dialog](#)
2. Adjust the contrast

Moving the **Contrast** slider to the right increases the contrast, and moving the slider to the left decreases the contrast.

You can also directly enter a value linked to the slider. Enter a value in the range from -50 to 50. The current settings are displayed in the settings preview on the left side of the printer driver.

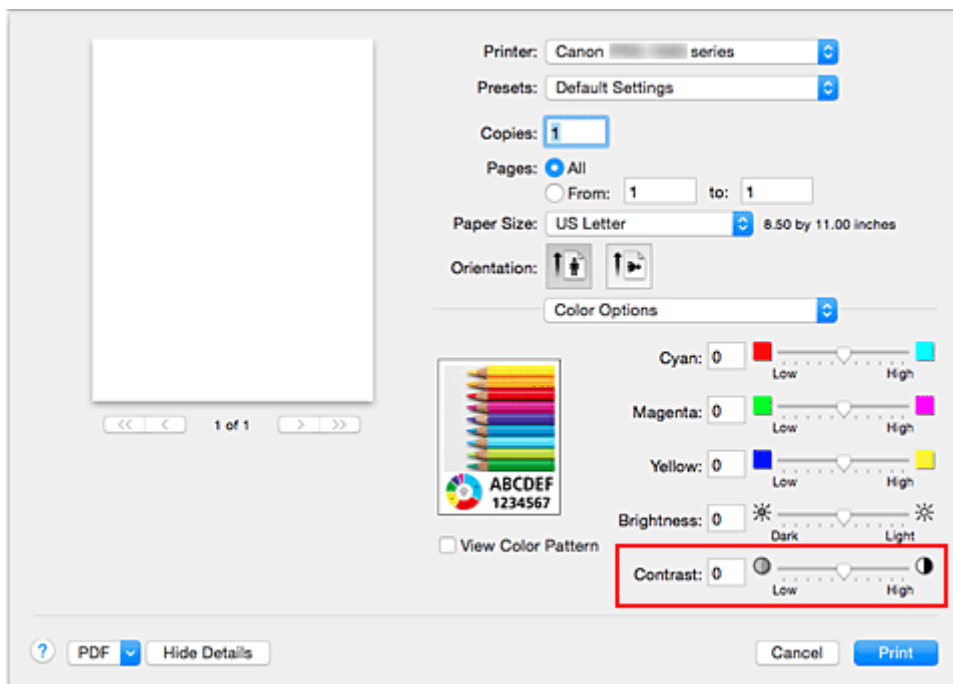

3. Complete the setup

Click **Print**.

When you execute print, the image is printed with the adjusted contrast.

»» Important

- If you select **ColorSync** for **Color Matching**, then the **Contrast** appears grayed out and is unavailable.

Related Topics

- [Setting the Print Quality Level \(Custom\)](#)
- [Specifying Color Correction](#)
- [Adjusting Color Balance](#)
- [Adjusting Brightness](#)

Printing Using a Web Service

- ▶ **Using PIXMA/MAXIFY Cloud Link**

- ▶ **Printing with Google Cloud Print**

- Getting Google Account
- Registering Printer with Google Cloud Print
- Printing from Computer or Smartphone with Google Cloud Print
- Deleting Printer from Google Cloud Print

- ▶ **Easy-PhotoPrint+ Guide**

Using PIXMA/MAXIFY Cloud Link

By using PIXMA/MAXIFY Cloud Link, you can connect your printer to a cloud service, such as CANON iMAGE GATEWAY, Evernote, or Twitter, and use the following functions without using a computer:

- Print images from a photo-sharing service
- Print documents from a data management service
- Save scanned images to a data management service.
- Use Twitter to report the printer status, such as no paper or low ink levels.

In addition, you can use various functions by adding and registering apps that are linked with various cloud services.

■ Using PIXMA/MAXIFY Cloud Link from Your Printer

■ [Using PIXMA/MAXIFY Cloud Link from Your Smartphone, Tablet, or Computer](#)



▶▶▶ Important

- In certain countries, PIXMA/MAXIFY Cloud Link may not be available or the available apps may be different.
- Some apps require that you have an account before you use those apps. For such apps, please set up an account beforehand.
- To find out which models support PIXMA/MAXIFY Cloud Link check the Canon homepage.
- The screen display may change without prior notice.

Printing with Google Cloud Print

The printer is compatible with Google Cloud Print™ (Google Cloud Print is a service provided by Google Inc.).

By using Google Cloud Print, you can print from anywhere with applications or services supporting Google Cloud Print.

Sending Print Data and Printing via Internet



Once you register the printer to Google Cloud Print, you can print from applications or services supporting Google Cloud Print without internet connection.

Sending Print Data and Printing without Going through Internet



►► Important

- This function may not be available depending on the country or region you live in.
- To use Google Cloud Print, you need to get Google account and register the printer with Google Cloud Print in advance.

Additionally, LAN connection with the printer and internet connection are required to register the printer to Google Cloud Print. Internet connection fees apply.

1. [Getting Google Account](#)
2. [Registering Printer with Google Cloud Print](#)
3. [Printing from Computer or Smartphone with Google Cloud Print](#)

►► Important

- When the printer owner changes, delete its registration from Google Cloud Print.

■ [Deleting Printer from Google Cloud Print](#)

LAN connection with the printer and internet connection are required to delete the printer from Google Cloud Print. Internet connection fees apply.

Getting Google Account

To print with Google Cloud Print, you need to get Google account and register the printer with Google Cloud Print in advance.

▶▶▶ Note

- If you already have Google account, register the printer to Google Cloud Print.

[Registering Printer with Google Cloud Print](#)

Access to Google Cloud Print with the web browser on the computer or the mobile device and register the required information.

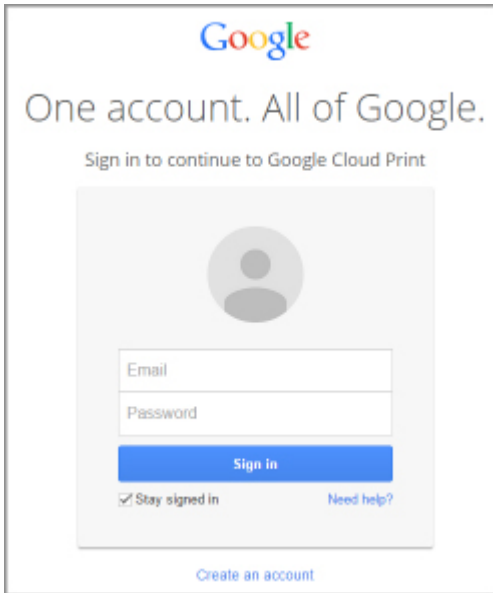

* The screen above may change without prior notice.

Registering Printer with Google Cloud Print



The printer can be registered to Google Cloud Print with the following two methods.

- [Registration Using Google Chrome](#)
- [Registration Using Printer](#)

▶▶▶ Important

- If you have not gotten Google account, get it.
[Getting Google Account](#)
- When the printer owner changes, delete its registration from Google Cloud Print.
■ [Deleting Printer from Google Cloud Print](#)
- LAN connection with the printer and internet connection are required to register the printer to Google Cloud Print and to delete it. Internet connection fees apply.

Registration Using Google Chrome

1. Start Google Chrome browser on your computer.
2. Select **Sign in to Chrome...** from  (Chrome menu).
3. Log in to your Google account.
4. Select **Settings** from  (Chrome menu).
5. Select **Show advanced settings...** to display information.
6. Select **Manage** for **Google Cloud Print**.
7. When printer's name and **Add printers** button are displayed, select **Add printers**.
8. When confirmation message for registering printer appears, select **OK**.
9. When register confirmation screen is displayed on printer's LCD, use ▲▼ button to select **Yes** and press **OK** button.
Printer registration is complete.

Registration Using Printer

▶▶▶ Important

- Entering the administrator password may be required depending on the range of administrator password.

1. [Make sure printer is turned on.](#)

2. Select  **Various settings** on HOME screen.

[LCD and Operation Panel](#)

3. Use **▲▼** button to select **Web service setup** and press **OK** button.
4. Select **Web service connection setup** -> **Google Cloud Print setup** -> **Register with Google Cloud Print**.

▶▶▶ Note

- If you have already registered the printer with Google Cloud Print, the confirmation message to re-register the printer is displayed.

5. When confirmation screen to register printer is displayed, use **▲▼** button to select **Yes** and press **OK** button.

6. Use **▲▼** button to select language on print setting screen of Google Cloud Print and press **OK** button.

The confirmation message to print the authentication URL is displayed.

7. Load A4 or Letter-sized plain paper and press **OK** button.

The authentication URL is printed.

8. Make sure authentication URL is printed, use **▲▼** button to select **Yes**, and then press **OK** button.

9. Perform authentication process using web browser on computer or mobile device.

Access to the URL using the web browser on the computer or the mobile device and perform the authentication process following the on-screen instructions.

▶▶▶ Important

- Accessing to printed URL and performing the authentication process have to be carried out quickly.
- If you exceed time limit of the authentication process, an error message is displayed on the LCD. Press the **OK** button. When the confirmation message to print the authentication URL is displayed, try again from step 7.

▶▶▶ Note

- Perform the authentication process with your Google account which you have gotten in advance.

10. When message that registration is complete is displayed on printer's LCD, press **OK** button.

When authentication process is complete properly, the registration items are displayed. When authentication process is complete, you can print the data with Google Cloud Print.

Printing from Computer or Smartphone with Google Cloud Print

When you send print data with Google Cloud Print, the printer receives the print data and prints it automatically.

When printing from a smartphone, tablet, computer, or other external device by using Google Cloud Print, load paper into the printer in advance.

You can print with Google Cloud Print with the following two methods.

- Printing via internet

LAN connection with the printer and internet connection are required.

■ [Sending Print Data via Internet](#)

- Printing without going through internet

Local network connection with the printer or enabling printer's direct connection is required. Enabling Bonjour on the printer is required.

■ [Sending Print Data without Going through Internet](#)

▶▶▶ Note

- Depending on the communication status, it may take a while to print the print data or the printer may not receive the print data.
- While printing with Google Cloud Print, the printing may be canceled depending on the printer's status, such as when the printer is being operated or an error has occurred. To resume printing, check the printer's status and print with Google Cloud Print again.
- For print settings:
 - If you select plain paper as media type or if you select B5/A5-size as paper size, the print data is printed with border even when you select the borderless print setting.
 - The print results may differ from the print image depending on the print data.
 - Depending on the device sending the print data, you may not select the print settings when sending the print data with Google Cloud Print.

Sending Print Data via Internet

This section describes the operation to send print data from Google Chrome browser on the computer. The operation differs depending on the device, applications, or services.

▶▶▶ Important



- LAN connection with the printer and internet connection are required to sending print data via internet. Internet connection fees apply.

1. [Make sure printer is turned on.](#)

▶▶▶ Note

- If the printer's Auto Power On function is enabled, the printer is turned on automatically when it receives the print data.

2. Start Google Chrome browser on your computer.

3. Select **Sign in to Chrome...** from  (Chrome menu).
4. Log in to your Google account.
5. Select **Print...** from  (Chrome menu).

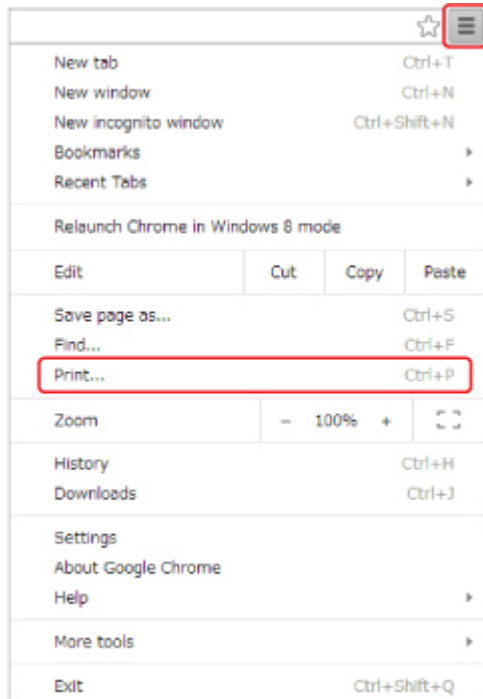

6. Select **Change...** next **Destination**.

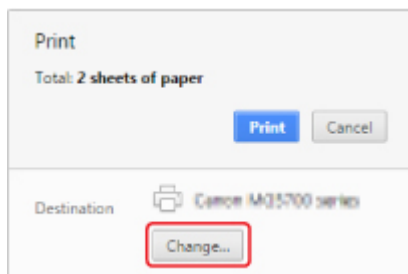

7. Select your printer's name in **Google Cloud Print**.
8. Select **Print**.

When the preparation for printing with Google Cloud Print is complete, the printer receives the print data and prints it automatically.

When you want to print from Google Cloud Print immediately

When the printer cannot receive the print data, or you want to start printing immediately, you can check whether there is a print job on the Google Cloud Print and start printing manually.

Follow the steps below.

1. [Make sure printer is turned on.](#)

2. Select  **Various settings** on HOME screen.

[LCD and Operation Panel](#)

3. Use ▲▼ button to select **Web service inquiry** and press **OK** button.

▶▶▶ Note

- If you have not registered the printer with Google Cloud Print, **Web service inquiry** is not displayed.

4. Use ▲▼ button to select **Print from Google Cloud Print** and press **OK** button.

The confirmation screen to check is displayed.

5. Use ◀▶ button to select **Yes** and press **OK** button.

If there is the print data, the printer receives the print data and prints it.

Sending Print Data without Going through Internet

This section describes the operation to send print data from Google Chrome browser on the computer. The operation differs depending on the device, applications, or services.

▶▶▶ Important

- Local network connection with the printer or enabling printer's direct connection is required.
- Enabling Bonjour on the printer is required.

1. [Make sure printer is turned on.](#)

▶▶▶ Note

- If the printer's Auto Power On function is enabled, the printer is turned on automatically when it receives the print data.

2. Start Google Chrome browser on your computer.

3. Select **Sign in to Chrome...** from  (Chrome menu).

4. Log in to your Google account.

5. Select **Print...** from  (Chrome menu).

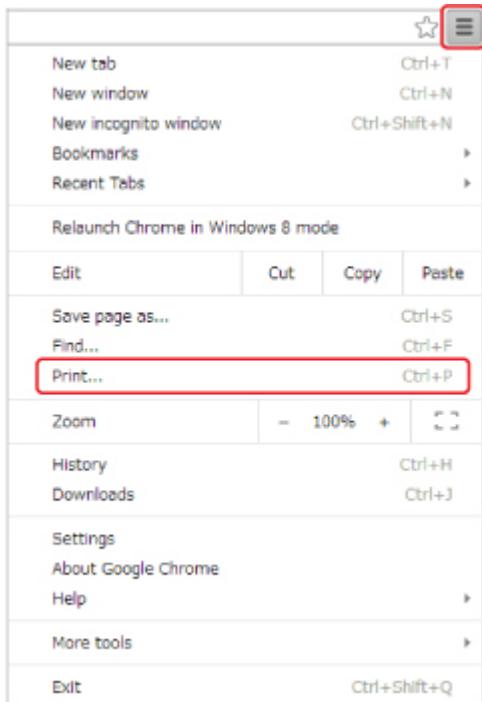

6. Select **Change...** next **Destination**.

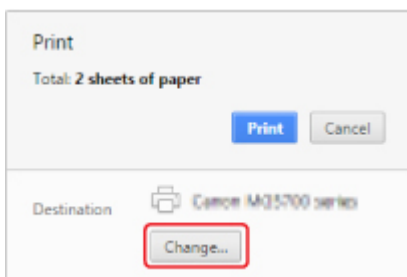

7. Select your printer's name in **Local Destinations**.

8. Select **Print**.

When the preparation for printing with Google Cloud Print is complete, the printer receives the print data and prints it automatically.

Deleting Printer from Google Cloud Print

If the printer's owner changes or if you want to re-register the printer, delete it from Google Cloud Print by following the steps below.

The printer can be deleted from Google Cloud Print with the following two methods.



■ [Deletion Using Google Chrome](#)

■ [Deletion Using Printer](#)

»» Important

- LAN connection with the printer and internet connection are required to delete the printer from Google Cloud Print. Internet connection fees apply.

Deletion Using Google Chrome

1. Start Google Chrome browser on your computer.
2. Select **Sign in to Chrome...** from  (Chrome menu).
3. Log in to your Google account.
4. Select **Settings** from  (Chrome menu).
5. Select **Show advanced settings...** to display information.
6. Select **Manage** for **Google Cloud Print**.
7. Select **Manage** next printer's name on device list.
8. Select **Delete**.
9. When confirmation message for deleting printer appears, select **OK**.

Deletion Using Printer

»» Important

- Entering the administrator password may be required depending on the range of administrator password.

1. [Make sure printer is turned on.](#)

2. Select  **Various settings** on HOME screen.

■ [LCD and Operation Panel](#)

3. Use ▲▼ button to select **Web service setup** and press **OK** button.
4. Select **Web service connection setup** -> **Google Cloud Print setup** -> **Delete from Google Cloud Print**.
5. When confirmation screen to delete printer is displayed, use ▲▼ button to select **Yes** and press **OK** button.
6. When message that deletion is complete is displayed, press **OK** button.

Printing from an AirPrint-enabled Printer with Mac

Using AirPrint to print from your iPhone, iPad, iPod touch, or Mac.

AirPrint enables you to print photos, email, Web pages and documents from iPhone, iPad, iPod touch, and Mac without the need to install drivers, or download apps or software.

»» Note

- If you want to print using AirPrint from iOS device, see below.

■ [Printing from an AirPrint-enabled Printer with iOS Device](#)



Checking Your Environment

First, check your environment.

- **AirPrint Operation Environment**
 - iPhone, iPad, and iPod touch running the latest version of iOS
 - Mac running the latest version of Mac OS

- **Connection method**

The iOS device or Mac and the printer must be connected to the same network over a LAN or connected directly without wireless router.

Adding Printer as AirPrint Printer to Your Mac

1. Open **System Preferences**, and select **Printers & Scanners (Print & Scan)** on your Mac.
2. Select **+** to display the printer list.
3. Select the printer's name listed as **Bonjour**.
4. Select **Secure AirPrint** or **AirPrint** from **Use**.
5. Select **Add**.

Printing with AirPrint from Mac

1. [Make sure printer is turned on.](#)

▶▶▶ Note

- If the printer's Auto Power On function is enabled, the printer is turned on automatically when it receives the print data.

2. [Load paper.](#)

3. Perform printing on your application software.

Print dialog appears.

4. Select your model name added as AirPrint printer from the **Printer** list in the Print Dialog.

5. Set the paper size, media type, and other settings as needed.

6. Select **Print**.

When you execute printing, the printer prints according to the specified settings.

▶▶▶ Note

- For wireless LAN connection:
 - After you turn on the printer, it may take few minutes before the printer can communicate through a wireless LAN connection. Make sure the printer is connected to the wireless LAN and try printing.
 - If Bonjour on the printer is disabled, AirPrint cannot be used. Check the LAN settings on the printer, and enable Bonjour.
- For other AirPrint troubleshooting, see below.

■ [Cannot Print Using AirPrint](#)

Checking Print Status

■ [Display the Printing Status Screen](#)

Deleting Print Job

To delete a print job with AirPrint, use one of the following two methods:

- From printer: Use **Stop** button to cancel the print job.
- From iOS device: [Deleting the Undesired Print Job](#)

Printing from Smartphone/Tablet

▶ **Printing Directly from Smartphone/Tablet**

- Android Print
- Printing from an AirPrint-enabled Printer with iOS Device
- Using Printer with Direct Connection

▶ **Printing Using a Web Service**

- Using PIXMA/MAXIFY Cloud Link
- Printing with Google Cloud Print

Printing Directly from Smartphone/Tablet

- ▶ **Android Print**
- ▶ **Printing from an AirPrint-enabled Printer with iOS Device**
- ▶ **Using Printer with Direct Connection**

Android Print

Use the Canon printing plug-in

Canon Print Service is a printing plug-in for Android 4.4.2 or later, and is available for free on Google Play. Installing and activating the plug-in enables your Android smartphone or tablet to print to a Canon printer over a wireless LAN.

Printing via Mopria

You can print to a Canon printer from a Mopria compatible Android smartphone or tablet over a wireless LAN.

See the Mopria homepage (<http://www.mopria.org>) for details including supported devices.

Printing from an AirPrint-enabled Printer with iOS Device

Using AirPrint to print from your iPhone, iPad, iPod touch, or Mac.

AirPrint enables you to print photos, email, Web pages and documents from iPhone, iPad, iPod touch, and Mac without the need to install drivers, or download apps or software.

»» Note

- If you want to print using AirPrint from Mac, see below.

■ [Printing from an AirPrint-enabled Printer with Mac](#)



Checking Your Environment

First, check your environment.

- **AirPrint Operation Environment**
 - iPhone, iPad, and iPod touch running the latest version of iOS
 - Mac running the latest version of Mac OS

- **Connection method**

The iOS device or Mac and the printer must be connected to the same network over a LAN or connected directly without wireless router.

Printing with AirPrint from iOS Device

1. [Make sure printer is turned on.](#)

»» Note

- If the printer's Auto Power On function is enabled, the printer is turned on automatically when it receives the print data.

2. [Load paper.](#)
3. Tap operation icon to display menu options from applications of your iOS device.

The figure below is an example of when printing from the iPad web browser. The screen differs depending on the devices or applications.

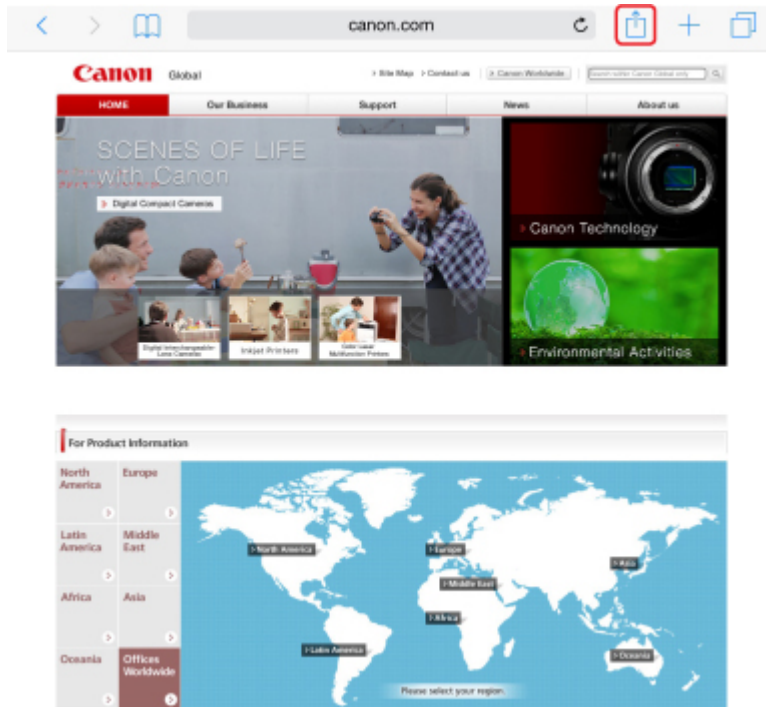

4. Tap **Print** from menu options.



5. Select your model name from **Printer** on **Printer Options**.

➤➤➤ **Important**

- Because some applications do not support AirPrint, **Printer Options** may not be displayed. If an application does not let you use printer options, you cannot print from that application.

➤➤➤ **Note**

- **Printer Options** differ depending on the application that you are using.

6. When printing file type that has multiple pages, such as PDF file, tap **Range** and tap **All Pages** or select range of pages to be printed.
7. For **1 Copy**, tap **+** or **-** to set number of required copies.
8. Tap **Print**.

When you execute printing, the printer prints according to the specified settings.

▶▶▶ Note

- For wireless LAN connection:
 - After you turn on the printer, it may take few minutes before the printer can communicate through a wireless LAN connection. Make sure the printer is connected to the wireless LAN and try printing.
 - If Bonjour on the printer is disabled, AirPrint cannot be used. Check the LAN settings on the printer, and enable Bonjour.
- For other AirPrint troubleshooting, see below.

■ [Cannot Print Using AirPrint](#)

Paper Size

With AirPrint, the paper size is selected automatically according to the application being used on the iOS device and the region in which AirPrint is used.

When you use the photo application, the default paper size is L size in Japan, and 4"x6" or KG in other countries and regions.

When you use the document application, the default paper size is letter size in the U.S. region, and A4 in Japan and Europe.

▶▶▶ Important

- Depending on the device or operation system, the default paper size is different from above size.
We recommend you perform test printing.
- Your application may support different paper sizes.

Checking Print Status

During printing, a **Print Center** icon is displayed in the list of recently used applications and you can use it to check the print progress.

Press the Home button on the iOS device twice to set the **Multitasking** mode. Then swipe to the right to display the **Print Center** icon and a **Print Summary**.

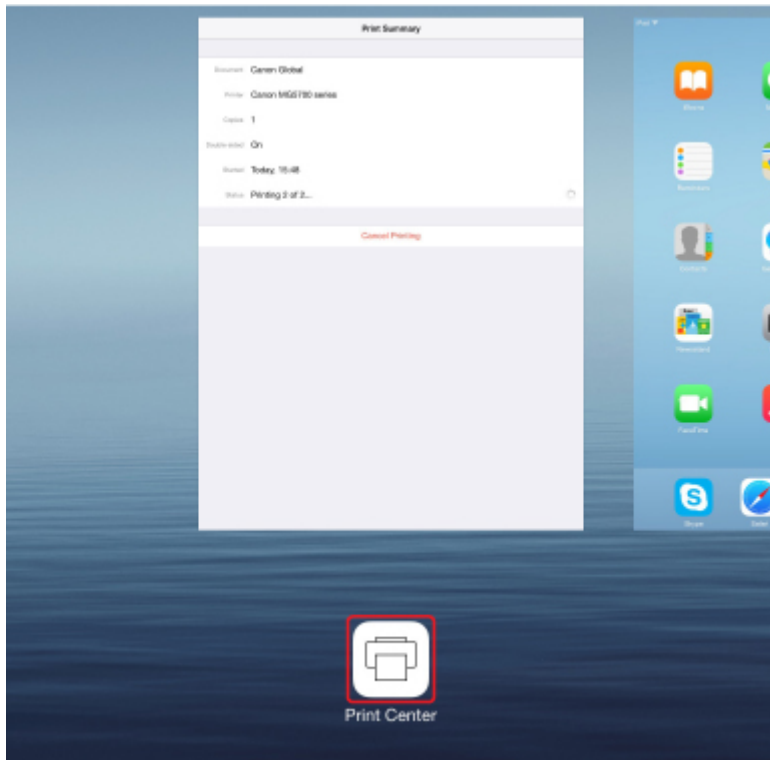

Deleting Print Job

To delete a print job with AirPrint, use one of the following two methods:

- From printer: Use **Stop** button to cancel the print job.
- From iOS device: Press the Home button on the iOS device twice to set the **Multitasking** mode and swipe to the right. Tap the **Print Center** icon to display a **Print Summary**. Tap the print job to be canceled and tap **Cancel Printing**.

Using Printer with Direct Connection

Direct connection allows you to print by connecting the printer to a device such as a smartphone or tablet via wireless connection in an environment where a wireless router is not available. In addition, you can connect the printer to a device without a wireless router even where it is available.

This section describes following operations for direct connection.

- Changing settings of the printer and device and connecting them wirelessly

■ [Preparing for Direct Connection](#)

- Printing from the device connected to the printer

■ [Printing with Direct Connection](#)

- Terminating direct connection and set the printer settings for normal use

■ [Terminating Direct Connection](#)

- Changing the settings for direct connection

■ [Changing Direct Connection Setting](#)

▶▶▶ Important

- This setting item is for the administrator. The administrator password is required to change settings.
- Before using the printer with the direct connection, check the usage restrictions and switch the printer to the direct connection.

■ [Restrictions](#)

Preparing for Direct Connection

Change settings below to prepare for direct connection.

■ [Changing printer's settings](#)

■ [Changing settings of a wireless communication device and connecting it to the printer](#)

- **Changing printer's settings**

1. [Make sure printer is turned on.](#)

2. Select  **LAN settings** on HOME screen.

■ [LCD and Operation Panel](#)

If you specify the administrator password, enter the password.

3. Use ▲▼ button to select **Change LAN** and press **OK** button.
4. Use ▲▼ button to select **Activate direct connect.** and press **OK** button.
5. Use ▲▼ button to select **Yes** and press **OK** button.

The identifier (SSID) for direct connection appears.

When a device detects the printer, the device detects the printer by the identifier (SSID).

▶▶▶ Note

- If you press the ▲▼ button to select **Details**, the following items appear.
 - Security setting
 - Password

- Machine's name which appears on a Wi-Fi Direct compatible device

The password is required when connecting a device to the printer. Depending on the device you are using, no password is required.

When you connect a Wi-Fi Direct compatible device to the printer, select the device name displayed on the LCD from your device.

- The identifier (SSID) and the security setting are specified automatically. To update them, see below.

■ [Changing Direct Connection Setting](#)

6. Use ▲▼ button to select **OK** and press **OK** button.

The direct connection is enabled and a wireless communication device can be connected to the printer wirelessly.

- **Changing settings of a wireless communication device and connecting it to the printer**

▶▶▶ Note

- Before connecting a device, we recommend you check the identifier (SSID) and the password for the direct connection.

To check the identifier (SSID) and the password, display them on the operation panel of the printer or print out the network setting information of the printer.

■ [LAN settings \(Item for administrator\)](#)

■ [Printing Network Settings](#)

1. Turn on wireless communication on your device.

Enable "Wi-Fi" on your device's "Setting" menu.

For more on turning on wireless communication, see your device's instruction manual.

2. Select "DIRECT-XXXX-PRO-YYYYseries" ("XXXX" represents alphanumeric characters, and "YYYY" represents numbers.) from list displayed on device.

3. Enter password.

Your device is connected to the printer.

▶▶▶ Note

- Depending on the wireless communication device you are using, entering the password is required to connect a device to the printer via wireless LAN. Enter the password specified for the printer.
- If your Wi-Fi Direct compatible device is set to prioritize using Wi-Fi Direct and it is connecting to the printer, the printer displays a confirmation screen asking if you allow the device to connect to the printer.

Make sure the name on the LCD is the same as that of your wireless communication device, select **Yes**, and then press the **OK** button.

Printing with Direct Connection

Connect a device and the printer with direct connection and start printing from the device.

»» Note

- For more on printing from a device via wireless LAN, refer to the device's or application's instruction manual.

Terminating Direct Connection

In environments that the printer is usually connected with the computer over the wireless LAN, set the printer to the wireless LAN connection following the procedure below when you finish using the printer with the direct connection temporarily.

1. Select  **LAN settings** on HOME screen.
[LCD and Operation Panel](#)
If you specify the administrator password, enter the password.
2. Use ▲▼ button to select **Change LAN** and press **OK** button.
3. Use ▲▼ button to select **Activate wireless LAN** and press **OK** button.
If you do not use the printer over wireless LAN, select **Activate wired LAN** or **Disable LAN**.

Changing Direct Connection Setting

Change the settings for the direct connection following the procedure below.

1. [Make sure printer is turned on.](#)
2. Select  **Various settings** on HOME screen.
[LCD and Operation Panel](#)
3. Use ▲▼ button to select **Device settings** and press **OK** button.
4. Use ▲▼ button to select **LAN settings** and press **OK** button.
If you specify the administrator password, enter the password.
5. Use ▲▼ button to select **Other settings** and press **OK** button.
6. Use ▲▼ button to select **Direct connection settings** and press **OK** button.
7. Use ▲▼ button to select an item and press **OK** button.

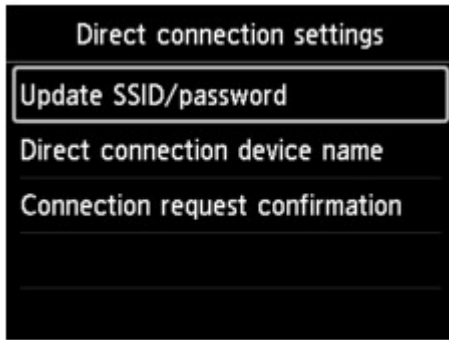

Update SSID/password

Update the identifier (SSID) and the password for direct connection.

When the confirmation screen appears, select **Yes** and press the **OK** button to update the identifier (SSID) and the password.

To check the security setting and the updated password, use the **▲▼** button to select **Details** and press the **OK** button. After that, select **Yes** on the screen displayed next and press the **OK** button.

Direct connection device name

Change the printer's name displayed on the Wi-Fi Direct compatible device.

Pressing the **OK** button displays the screen to specify the device name.

Follow the procedure below to change the name.

1. Press **OK** button.
2. Enter device name (up to 32 characters).
3. Use **▲▼◀▶** button to select **OK** and press **OK** button.
4. Press **OK** button to finish entering device name.

Connection request confirmation

Change the confirmation screen setting when a Wi-Fi Direct compatible device is connecting to the printer.

Pressing the **OK** button displays the confirmation screen. If you want the printer to display the screen to inform you a Wi-Fi Direct device is connecting to the printer, select **Yes** and press the **OK** button.

►► Important

- To prevent an unauthorized access, we recommended you should not change the setting from the default.

When you finished performing the settings, the printer returns to the **Direct connection settings** screen.

8. Press **HOME** button.

The HOME screen is displayed.

►► Note

- If you change the direct connection setting of the printer, also change the wireless router setting of the device.

Printing Using a Web Service

- ▶ **Using PIXMA/MAXIFY Cloud Link**
- ▶ **Printing with Google Cloud Print**

Using PIXMA/MAXIFY Cloud Link

By using PIXMA/MAXIFY Cloud Link, you can connect your printer to a cloud service, such as CANON IMAGE GATEWAY, Evernote, or Twitter, and use the following functions without using a computer:

- Print images from a photo-sharing service
- Print documents from a data management service
- Save scanned images to a data management service.
- Use Twitter to report the printer status, such as no paper or low ink levels.

In addition, you can use various functions by adding and registering apps that are linked with various cloud services.

■ Using PIXMA/MAXIFY Cloud Link from Your Printer

■ [Using PIXMA/MAXIFY Cloud Link from Your Smartphone, Tablet, or Computer](#)



▶▶▶ Important

- In certain countries, PIXMA/MAXIFY Cloud Link may not be available or the available apps may be different.
- Some apps require that you have an account before you use those apps. For such apps, please set up an account beforehand.
- To find out which models support PIXMA/MAXIFY Cloud Link check the Canon homepage.
- The screen display may change without prior notice.

Printing with Google Cloud Print

The printer is compatible with Google Cloud Print™ (Google Cloud Print is a service provided by Google Inc.).

By using Google Cloud Print, you can print from anywhere with applications or services supporting Google Cloud Print.

Sending Print Data and Printing via Internet



Once you register the printer to Google Cloud Print, you can print from applications or services supporting Google Cloud Print without internet connection.

Sending Print Data and Printing without Going through Internet



►► Important

- This function may not be available depending on the country or region you live in.
- To use Google Cloud Print, you need to get Google account and register the printer with Google Cloud Print in advance.

Additionally, LAN connection with the printer and internet connection are required to register the printer to Google Cloud Print. Internet connection fees apply.

1. [Getting Google Account](#)
2. [Registering Printer with Google Cloud Print](#)
3. [Printing from Computer or Smartphone with Google Cloud Print](#)

►► Important

- When the printer owner changes, delete its registration from Google Cloud Print.

■ [Deleting Printer from Google Cloud Print](#)

LAN connection with the printer and internet connection are required to delete the printer from Google Cloud Print. Internet connection fees apply.

Printing Using Operation Panel

- ▶ [Printing Templates Such as Lined or Graph Paper](#)

Printing Templates Such as Lined or Graph Paper

You can print a template form such as lined paper, graph paper, or checklist, etc. on plain paper.

■ [Printable template forms](#)

■ [Printing template forms](#)

Printable template forms

The following templates are available:

- **Notebook paper**



You can select three line spacing formats.

Print on A4 or Letter-sized plain paper.

Setting on the LCD:

- **Notebook paper 1 (8 mm)**
- **Notebook paper 2 (7 mm)**
- **Notebook paper 3 (6 mm)**

- **Graph paper**



You can select two square sizes.

Print on A2, A3, A4, or Letter-sized plain paper.

Setting on the LCD:

- **Graph paper 1 (5 mm grid)**
- **Graph paper 2 (3 mm grid)**
- **Graph paper 3 (1 mm grid)**
- **Graph paper 4 (5 cm grid)**

- **Checklist**



You can print a notepad with checkboxes.

Print on A4, B5, or Letter-sized plain paper.

Setting on the LCD:

Checklist

- **Staff paper**

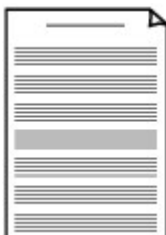

You can print staff paper with 10 or 12 staves.

Print on A4, B5, or Letter-sized plain paper.

Setting on the LCD:

- **Staff paper 1 (10 staves)**
- **Staff paper 2 (12 staves)**

- **Handwriting paper**



You can print handwriting paper.
Print on A4, B5, or Letter-sized plain paper.
Setting on the LCD:
Handwriting paper (3 lines)

- **Weekly schedule**

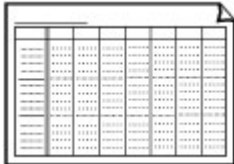

You can print a weekly schedule form.
Print on A4, B5, or Letter-sized plain paper.
Setting on the LCD:
Weekly schedule (vertical)

- **Monthly schedule**

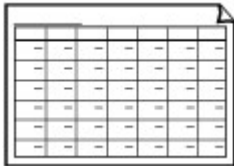

You can print a monthly schedule form.
Print on A4, B5, or Letter-sized plain paper.
Setting on the LCD:
Monthly schedule(calendar)

Printing template forms

Print template form following the procedure below.

1. [Make sure printer is turned on.](#)
2. [Load plain paper.](#)

3. Select  **Template print** on HOME screen.

 [LCD and Operation Panel](#)

4. Use ▲▼ button to select the template you want to print and press **OK** button.

 [Printable template forms](#)

5. Use ▲▼ button to specify the number of copies and press **OK** button.

6. Use ▲▼ button to select paper size and press **OK** button.

The printer starts printing.

Printing from Digital Camera

- **Printing Photographs Directly from PictBridge (Wireless LAN) Compliant Device**
- **PictBridge (Wireless LAN) Print Settings**

Printing Photographs Directly from PictBridge (Wireless LAN) Compliant Device

You can connect a PictBridge (Wireless LAN) compliant device such as a digital camera, camcorder, or mobile phone to the printer through LAN, and print recorded images directly without using a computer.

Connectable devices:

PictBridge (Wireless LAN) compliant device

Printable image data format:

The printer accepts images* taken with a camera compliant with the Design rule for Camera File system.

▶▶▶ Important

- LAN connection with the printer is required to use this function.

▶▶▶ Note

- PictBridge is the Standard to print your photos directly without using a computer, connecting a device such as a digital still camera, digital camcorder, or camera-equipped mobile phone.

In this manual, PictBridge printing with the wireless LAN connection is referred to as "PictBridge (Wireless LAN)."

- When printing photos with the PictBridge (Wireless LAN) compliant device connected to the printer, we recommend the use of the AC adapter supplied with the device. If you are using the device battery, be sure to charge it fully.
- Depending on the model or brand of your device, you may have to select a print mode compliant with PictBridge (Wireless LAN) before connecting the device. You may also have to turn on the device or select Play mode manually after connecting the device to the printer.

Perform necessary operations on the PictBridge (Wireless LAN) compliant device before connecting it to this printer according to instructions given in the device's instruction manual.

1. [Make sure printer is turned on.](#)
2. [Load paper.](#)
3. Connect PictBridge (Wireless LAN) compliant device to printer.

Detect the printer with the PictBridge (Wireless LAN) compliant device and connect the PictBridge (Wireless LAN) compliant device to the printer with LAN.

▶▶▶ Note

- For more on detecting the printer, refer to your PictBridge (Wireless LAN) compliant device's instruction manual.

4. Specify print settings such as paper type and layout.

You can perform settings using the menu on the LCD of your PictBridge (Wireless LAN) compliant device. Select the size and type of paper that you loaded in the printer.

■ [Settings on PictBridge \(Wireless LAN\) Compliant Device](#)

If your PictBridge (Wireless LAN) compliant device does not have a setting menu, change the setting from the printer.

■ [Settings on Printer](#)

▶▶ Note

- When printing from the PictBridge (Wireless LAN) compliant device, set the print quality with the operation panel on the printer. You cannot set the print quality on the PictBridge (Wireless LAN) compliant device.

5. Start printing from your PictBridge (Wireless LAN) compliant device.

PictBridge (Wireless LAN) Print Settings

■ [Settings on PictBridge \(Wireless LAN\) Compliant Device](#)

■ [Settings on Printer](#)

Settings on PictBridge (Wireless LAN) Compliant Device

This section describes the PictBridge (Wireless LAN) function of the printer. For the print settings on a PictBridge (Wireless LAN) compliant device, refer to the instructions given in the device's instruction manual.

▶▶ Note

- In the following description, names of setting items are given according to those used in Canon-brand PictBridge (Wireless LAN) compliant devices. Setting item names may be different depending on the brand or model of your device.
- Some setting items explained below may not be available on some devices. In this case, the settings made on the printer are applied. Also, when some items are set to **Default** on a PictBridge (Wireless LAN) compliant device, the printer settings for these items are applied.

■ [PictBridge print settings](#)

The following settings can be used when printing from a PictBridge (Wireless LAN) compliant device.

Paper size	4" x 6"/ 10 x 15 cm, 5" x 7"* , 8" x 10"/ 20 x 25 cm, A4, 8.5" x 11"(Letter), A3, A3+/ 13" x 19", A2 * Can be selected only on certain Canon-brand PictBridge (Wireless LAN) compliant devices. (May not be selected depending on the device.)
Paper type	<ul style="list-style-type: none"> • Default: Photo Paper Plus Semi-gloss SG-201/Photo Paper Pro Luster LU-101 • Photo: Photo Paper Plus Glossy II PP-201 • Fast Photo: Photo Paper Pro Platinum PT-101 • Plain: A3, A4, or Letter sized plain paper <p>When Paper type is set to Plain, borderless printing will be disabled even when Layout is set to Borderless.</p>
Layout	<p>Default (Selections based on the printer setting), Index, Bordered, Borderless, 20-up*1, 35-up*2</p> <p>*1 With a Canon brand PictBridge (Wireless LAN) compliant device, selecting items with "i" mark allows you to print shooting info (Exif Data) in list format (20-up) or on the margins of the specified data (1-up). (May not be available with some Canon-brand PictBridge (Wireless LAN) compliant devices.)</p> <p>*2 Printed in 35 mm Film Style Layout (Contact Printing Layout). Available only with a Canon-brand PictBridge (Wireless LAN) compliant device. (May not be available with some Canon-brand PictBridge (Wireless LAN) compliant devices.)</p>
Print date & file no.	Default (Off: No printing), Date, File No., Both, Off

Image optimize	Default (Selections based on the printer setting), On (Auto photo fix)*1, Off, Red-Eye correction*2 *1 The scene or person's face of a shot photo is recognized and the most suitable correction for each photo is made automatically. It makes a darkened face by backlight brighter to print. It also analyzes a scene such as scenery, night scene, person, etc. and corrects each scene with the most suitable color, brightness, or contrasts automatically to print. *2 Can be selected only on certain Canon-brand PictBridge (Wireless LAN) compliant devices. (May not be selected depending on the device.)
Trimming	Default (Off: No trimming), On (follow the camera's setting), Off

Settings on Printer

You can change the PictBridge (Wireless LAN) print settings from the **PictBridge print settings** screen. Set the print settings to **Default** on the PictBridge (Wireless LAN) compliant device when you want to print according to the settings on the printer.

This section describes the procedure to display the **PictBridge print settings** screen.

1. [Make sure printer is turned on.](#)

2. Select  **Various settings** on HOME screen.

 [LCD and Operation Panel](#)

3. Use ▲▼ button to select **Device settings** and press **OK** button.
4. Use ▲▼ button to select **PictBridge print settings** and press **OK** button.
5. Check message that is displayed and press **OK** button.

The **PictBridge print settings** screen is displayed.

For more on the setting items:

 [PictBridge print settings](#)

Windows Software

▶ **Printer Driver**

- Overview of the Printer Driver
- Printer Driver Description
- Updating the Printer Driver
- Sharing the Printer on a Network

▶ **Printing Using Canon Application Software**

- [My Image Garden Guide](#)
- [Print Studio Pro Guide](#)
- [Digital Photo Printing Guide](#)
- [Quick Utility Toolbox Guide](#)
- [Media Configuration Tool Guide](#)
- [Device Management Console Guide](#)
- [Accounting Manager Guide](#)

Printing Using Canon Application Software

- ▶ **My Image Garden Guide**
- ▶ **Print Studio Pro Guide**
- ▶ **Digital Photo Printing Guide**
- ▶ **Quick Utility Toolbox Guide**
- ▶ **Media Configuration Tool Guide**
- ▶ **Device Management Console Guide**
- ▶ **Accounting Manager Guide**

My Image Garden Guide

You can learn about the operations and screens of My Image Garden.



For Windows:

Latest Version

My Image Garden V3.3.x/V3.2.x

It is recommended that you use the latest version of the application.

Access the Canon website and download the latest application.

[How to Check the Version](#) ▶

Earlier Versions

Select the version of your My Image Garden.

- V3.1.x/V3.0.x
- V2.1.x
- V2.0.x
- V1.1.x

For Mac OS:

Latest Version

My Image Garden V3.3.x/V3.2.x

It is recommended that you use the latest version of the application.

Access the Canon website and download the latest application.

[How to Check the Version](#) ▶

Earlier Versions

Select the version of your My Image Garden.

- V3.1.x/V3.0.x
- V2.1.x
- V2.0.x
- V1.1.x

Print Studio Pro Guide

You can learn about the operations and screens of Print Studio Pro.



For Windows:

Latest Version

Print Studio Pro V2.0.x

It is recommended that you use the latest version of the application.

Access the Canon website and download the latest application.

- Print Studio Pro V2.0.0 or later is not available when using Pro9500 Mark II series or Pro9000 Mark II series.
- When using PRO-1 series, you need to upgrade the printer driver and other software to the latest versions to use Print Studio Pro V2.0.x.

[How to Check the Version](#) ▶

Earlier Versions

Select the version of your Print Studio Pro.

- V1.4.x
- V1.3.6/V1.3.5
- V1.3.0
- V1.2.x

For Mac OS:

Latest Version

Print Studio Pro V2.0.x

It is recommended that you use the latest version of the application.

Access the Canon website and download the latest application.

- Print Studio Pro V2.0.0 or later is not available when using Pro9500 Mark II series or Pro9000 Mark II series.
- When using PRO-1 series, you need to upgrade the printer driver and other software to the latest versions to use Print Studio Pro V2.0.x.

[How to Check the Version](#) ▶

Earlier Versions

Select the version of your Print Studio Pro.

- V1.4.x

■ V1.3.6/V1.3.5

■ V1.3.0

■ V1.2.x

I want to keep my precious photos beautiful. I want to transform photos into works of art as I wish.
To make such wishes come true,
master printing techniques that maximize the printer's performance!



Digital Photo Print

- Lesson 1 Digital Printing Workflow Explains the basic printing procedure for producing beautiful photos as you wish
- Lesson 2 Color Management Basics Explains the basic knowledge of color management that is essential to maximizing the printer's performance and to producing rewarding photos
- Lesson 3 Utilizing Print Studio Pro By using Print Studio Pro, you can perform various printing tasks more easily by fully utilizing the information captured with a digital camera
- Lesson 4 Techniques for Specific Objectives By simply applying a little technique, you can achieve the impression you want to represent
- Appendix Useful Information Describes the information that is useful to know, such as types of ink and media (paper)

Quick Utility Toolbox Guide

You can learn about the operations and screens of Quick Utility Toolbox.



For Windows:

Latest Version

Quick Utility Toolbox V2.0.x

It is recommended that you use the latest version of the application.

Access the Canon website and download the latest application.

[How to Check the Version](#) ▶

For Mac OS:

Latest Version

Quick Utility Toolbox V2.0.x

It is recommended that you use the latest version of the application.

Access the Canon website and download the latest application.

[How to Check the Version](#) ▶

Media Configuration Tool Guide

You can learn about the operations and screens of Media Configuration Tool.

For Windows:

Latest Version

Media Configuration Tool V1.0.x

It is recommended that you use the latest version of the application.

Access the Canon website and download the latest application.

Device Management Console Guide

You can learn about the operations and screens of Device Management Console.

For Windows:

Latest Version

Device Management Console V1.0.x

It is recommended that you use the latest version of the application.

Access the Canon website and download the latest application.

For Mac OS:

Latest Version

Device Management Console V1.0.x

It is recommended that you use the latest version of the application.

Access the Canon website and download the latest application.

Accounting Manager Guide

You can learn about the operations and screens of Accounting Manager.

For Windows:

Latest Version

Accounting Manager V1.0.x

It is recommended that you use the latest version of the application.

Access the Canon website and download the latest application.

For Mac OS:

Latest Version

Accounting Manager V1.0.x

It is recommended that you use the latest version of the application.

Access the Canon website and download the latest application.

Mac OS Software

► **Printer Driver**

- Overview of the Printer Driver
- Updating the Printer Driver
- Sharing the Printer on a Network

► **Printing Using Canon Application Software**

- My Image Garden Guide
- Print Studio Pro Guide
- Digital Photo Printing Guide
- Quick Utility Toolbox Guide
- Device Management Console Guide
- Accounting Manager Guide

Printer Driver

- ▶ **Overview of the Printer Driver**
- ▶ **Updating the Printer Driver**
- ▶ **Sharing the Printer on a Network**

Overview of the Printer Driver

- ▶ **Canon IJ Printer Driver**
- ▶ **How to Open the Printer Driver Setup Window**
- ▶ **Page Setup Dialog**
- ▶ **Print Dialog**
- ▶ **Registering a Changed Printing Profile**
- ▶ **Quality & Media**
- ▶ **Color Options**
- ▶ **Paper Detailed Settings**
- ▶ **Page Processing**
- ▶ **Canon IJ Printer Utility2**
- ▶ **Opening the Canon IJ Printer Utility2**
- ▶ **Changing Printer Settings from Your Computer (Mac OS)**
- ▶ **Maintenance of this Printer**
- ▶ **Display the Printing Status Screen**
- ▶ **Deleting the Undesired Print Job**
- ▶ **Instructions for Use (Printer Driver)**

Canon IJ Printer Driver

The Canon IJ printer driver (called printer driver below) is a software that is installed on your computer for printing data with this printer.

The printer driver converts the print data created by your application software into data that your printer can understand, and sends the converted data to the printer.

Because different models support different print data formats, you need a printer driver for the specific model you are using.

Using Help of the Printer Driver

You can display Help function from the [Print Dialog](#).

Select a setup item from the pop-up menu in the Print dialog. Then click  at the bottom left of the screen to display an explanation of the item.

Help for the printer driver is displayed when the following pop-up menu item is selected:

- **Quality & Media**
- **Color Options**
- **Paper Detailed Settings**
- **Page Processing**

How to Open the Printer Driver Setup Window

You can display the printer driver setup window from the application software you are using.

Opening the Page Setup Dialog

Use this procedure to set the page (paper) settings before printing.

1. Select **Page Setup...** from the **File** menu of the application software

The [Page Setup Dialog](#) opens.

Opening the Print Dialog

Use this procedure to set the print settings before printing.

1. Select **Print...** from the **File** menu of the application software

The [Print Dialog](#) opens.

Page Setup Dialog

In the Page Setup dialog, you configure the basic print settings such as the size of paper loaded in the printer or the scaling ratio.

To open the Page Setup dialog, you typically select **Page Setup...** from the **File** menu of your application software.

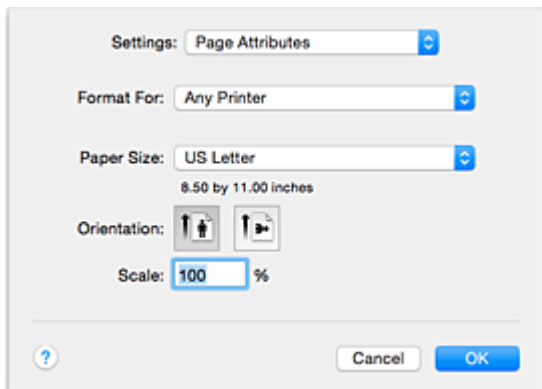

Settings

Click the pop-up menu, and then select the following items:

Page Attributes

Set the paper size or scaled printing.

Save as Default

You can save the attributes of the displayed page as the default settings.

Format For

Select the model to be used for printing.

Paper Size

Select the size of the paper to be used for printing.

To set a non-standard size, select **Manage Custom Sizes...**

Orientation

Select the print orientation.

Scale

Set the scaling percentage.

You can expand or reduce the size of the document when printing.

Print Dialog

In the Print dialog, you can set paper type, paper source and print quality to start printing.

To open the Print dialog, you typically select **Print...** from the **File** menu of your application software.

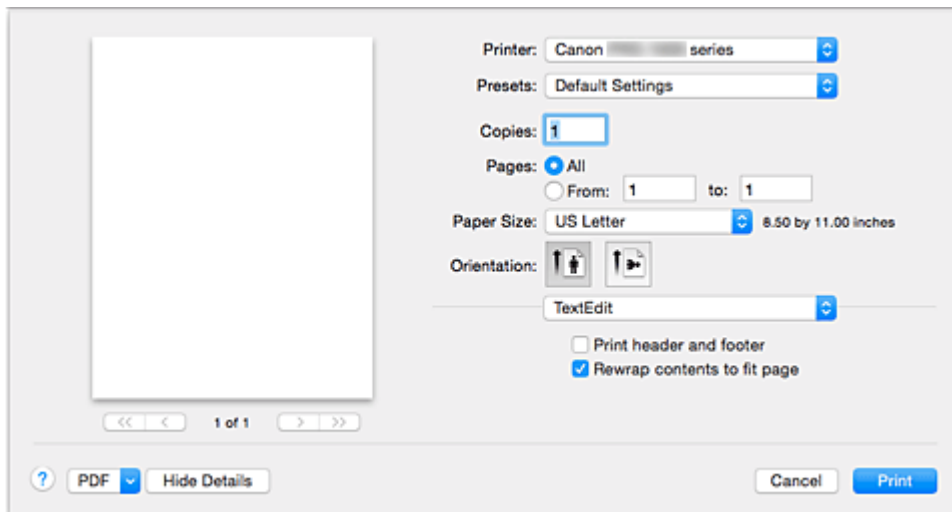

Printer

Select the model to be used for printing.

When you click **Add Printer...**, a dialog for specifying the printer opens.

Presets

You can save or delete the settings of the Print dialog.

►►► Note

- You can select **Show Presets...** to check the print settings that are set in the Print dialog.

Copies

You can set the number of copies to be printed.

►►► Note

- You can set collated printing by choosing **Paper Handling** from the pop-up menu.

Pages

You can set the range of pages to be printed.

Paper Size

Select the size of the paper to be used for printing.

To set a non-standard size, select **Manage Custom Sizes...**

Orientation

Select the print orientation.

Pop-up Menu

You can switch between pages in the Print dialog by the pop-up menu. The first menu to appear differs depending on the application software that opened the Print dialog.

You can choose one of the following items from the pop-up menu.

Layout

You can set page layout printing.

Use **Reverse page orientation** to change the paper orientation, and use **Flip horizontally** to print a mirror image of the document.

Color Matching

You can select the color correction method.

Paper Handling

You can set the pages to be printed on paper and the print order.

Cover Page

You can output cover pages both before and after a document.

Quality & Media

You can set basic print settings that match the printer.

Color Options

You can adjust the print colors as you desire.

Paper Detailed Settings

Specifies detailed print settings that match the media type loaded in the printer.

Page Processing

Adjusts how much of the document extends outside the paper when full-page borderless printing is used, and specifies the stapling side and stapling margin when multiple sheets of paper are being stapled together.

Supply Levels

A rough indication of the remaining ink level is displayed.

PDF

You can save a document in PDF (Portable Document Format) format.

Registering a Changed Printing Profile

You can name and register the printing profile you made in the [Print Dialog](#). The registered printing profile can be called up from **Presets** to be used. You can also delete the unnecessary printing profile.

The procedure for registering a printing profile is as follows:

Registering a Printing Profile

1. In the Print dialog, set the necessary items
2. Select **Save Current Settings as Preset...** from the **Presets**

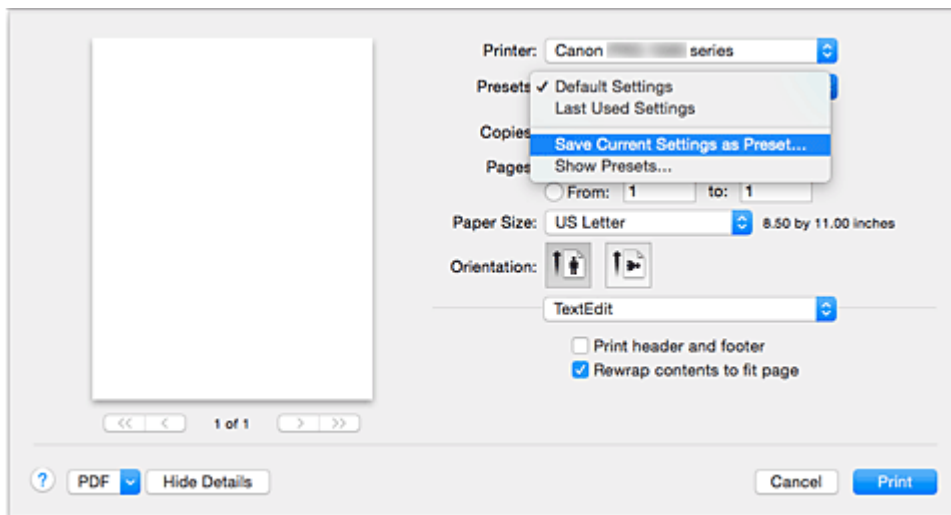

3. Save the settings

In the displayed dialog, enter a name in **Preset Name**, and if necessary, set **Preset Available For**. Then click **OK**.

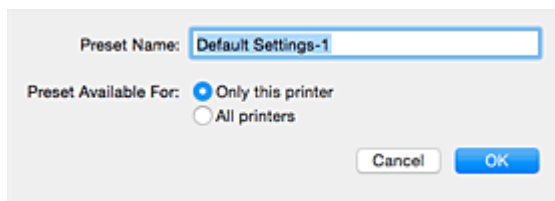

Important

- There are also print settings that cannot be saved to preset.

Using Registered Printing Profile

1. On **Presets** in the Print dialog, select the name of printing profile you want to use
Printing profile in the Print dialog will be updated to the called profile.

Deleting Unnecessary Printing Profile

1. Select the printing profile to be deleted

In the print dialog, select **Show Presets...** in the **Presets** section. Then in the dialog that appears, select the name of the printing profile to be deleted.

2. Delete the printing profile

Click **Delete**, and click **OK**. The selected printing profiles will be deleted from **Presets**.

Quality & Media

This dialog allows you to create a basic print setup in accordance with the paper type. Unless special printing is required, normal printing can be performed just by setting the items in this dialog.

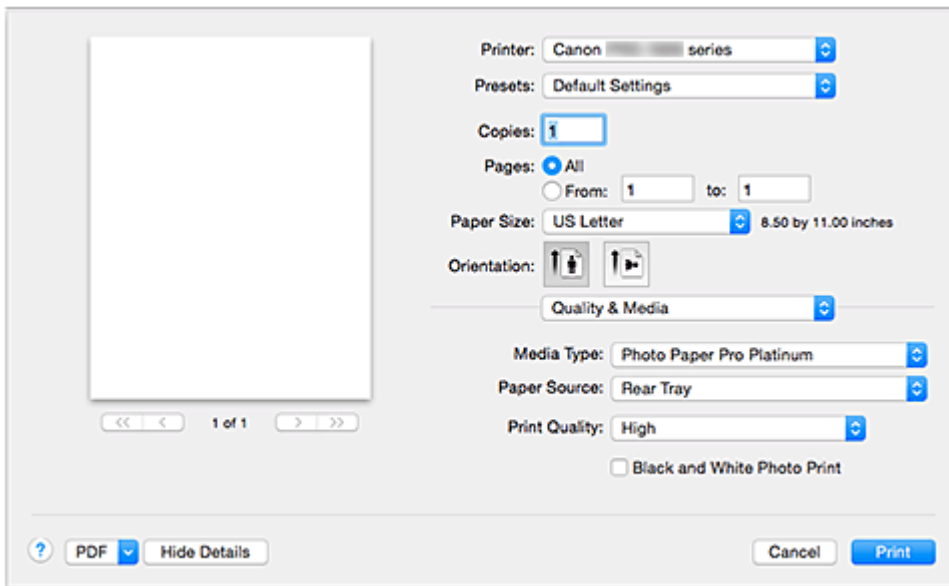

Media Type

Select the type of media to be used.

You must select the type of media actually loaded in the printer. This selection enables the printer to carry out printing properly for the material of the media used.

▶▶▶ Note

- When printing on a double postcard, select Postcard Double for Paper Size, and then print again.
- If you print on paper other than hagaki, load the paper according to usage instructions, and then click **OK**.
- If  is displayed, start up the Canon IJ Printer Utility2 and either correct or update media information.

Paper Source

Select the source from which paper is supplied.

Manual Feed

Paper is supplied from the manual feed tray in the back.

Rear Tray

Paper is fed from the rear tray.

Print Quality

Select the one that is closest to the original document type and the purpose.

When one of the radio buttons is selected, the appropriate quality will be set automatically.

Highest

Prints with quality as the highest priority.

High

Gives priority to print quality over printing speed.

Standard

Prints with average speed and quality.

Custom

Select this radio button to specify a quality.

Quality

When you select **Custom** in **Print Quality**, you can use the slider bar to adjust the print quality level.

Black and White Photo Print

Set black and white photo printing. Black and white photo printing refers to the function of converting your document to grayscale data in the printer to print it in monochrome.

When you check the check box, both monochrome and color documents will be printed in monochrome.

When printing a color document, be sure to uncheck the check box.

Related Topics

- [Switching the Paper Source to Match the Purpose](#)
- [Setting the Print Quality Level \(Custom\)](#)
- [Printing a Color Document in Monochrome](#)

Color Options

This dialog allows you to adjust the print color as you like. If the color of the printed image is not as expected, adjust the properties in the dialog and retry printing.

The adjustments made here do not affect the colors of the original print data unlike application software dedicated to image processing. Use this dialog just to make fine adjustments.

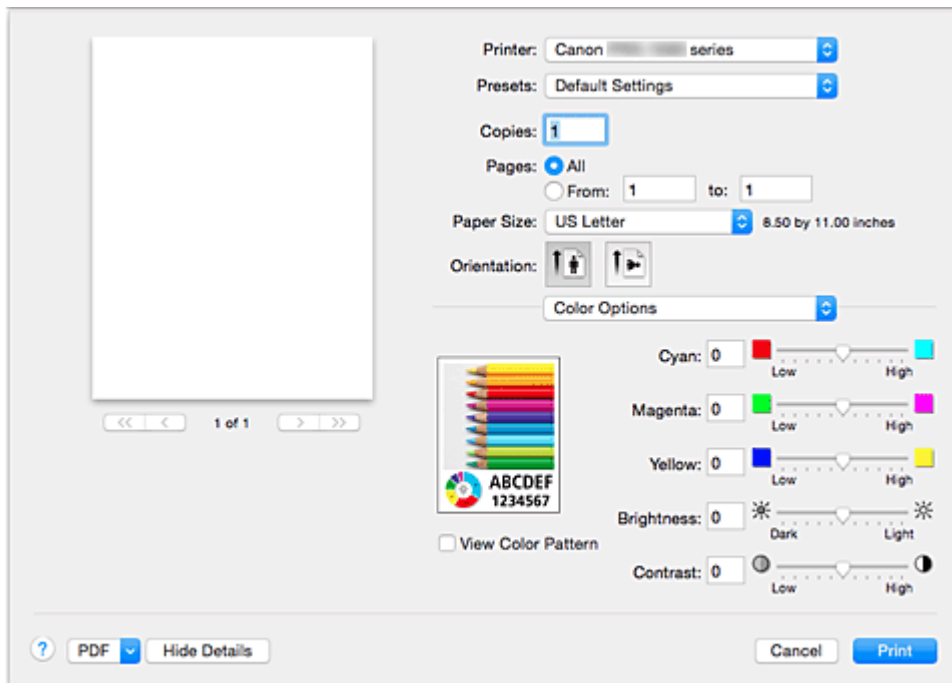

Preview

Shows the effect of color adjustment.

As you adjust each item, the effects are reflected in the color and brightness.

View Color Pattern

Displays a pattern for checking color changes produced by color adjustment.

When you want to display the sample image with a color pattern, check this check box.

►►► Note

- When the **Black and White Photo Print** check box is checked in the **Quality & Media**, the graphic is displayed in monochrome.

Color balance (Cyan, Magenta, Yellow)

If necessary, adjust the strength of each color. To strengthen a color, drag the slider to the right. To weaken a color, drag the slider to the left.

You can also directly enter a value linked to the slider. Enter a value in the range from -50 to 50.

Adjusting the color balance will result in variations in the balance among the volumes of the individual color inks and hence in the hues of the document as a whole.

Use the printer driver only when adjusting the color balance slightly. To change the color balance significantly, use the application software.

Tone

Sets the color adjustment for monochrome printing.

You can select **Cool Tone**, **Black and White**, **Warm Tone** or **Custom**.

You can also enter **X** and **Y** values while checking the color tone, click the adjustment area with the mouse, or adjust the tone by dragging the slider.

Cool Tone

This item adjusts color tones to cool shades of gray (cool black). When you select **Cool Tone**, a value of -30, is entered for **X**, and a value of 0 for **Y**.

Black and White

This item adjusts color tones to neutral shades of gray. When you select **Black and White**, a value of 0 is entered for **X**, and a value of 0 for **Y**.

Warm Tone

This item adjusts color tones to warm shades of gray (warm black). When you select **Warm Tone**, a value of 30 is entered for **X**, and a value of 0 for **Y**.

Custom

You can adjust the color tones while checking the colors in the adjustment area. To adjust the color tones, either enter values directly or click the up/down arrows. You can also adjust the color tones by clicking or dragging the adjustment area with the mouse. If you select another color tone and then select **Custom** again, the values that were preset in **Custom** are restored.

X, Y (Monochromatic adjustment value)

If necessary, you can adjust monochromatic colors manually. To adjust the color tones, either enter values directly or click the up/down arrows. You can also adjust the color tones by clicking or dragging the adjustment area with the mouse. When you enter values, set values in the range of -100 to 100 for **X**, and -50 to 50 for **Y**. The selected value will be shown in the preview on the left side.

»» Important

- **Tone** and **X, Y** (Monochromatic adjustment value) are displayed when **Black and White Photo Print** check box is selected for **Quality & Media**.
- When selecting **Plain Paper**, **Matte Photo Paper**, **Hagaki A**, **Ink Jet Hagaki**, or **Hagaki** as the **Media Type** under **Quality & Media**, the **Tone**, **X**, and **Y** options will be grayed out and you will be unable to use these settings.

Brightness

Adjusts the brightness of your print. You cannot change the levels of pure white and black. However, the brightness of the colors between white and black can be changed. Colors become brighter as you drag the slider toward the right and darker as you drag the slider toward the left. You can also directly enter brightness values that are linked to the slider bar. Enter a value in the range from -50 to 50.

Contrast

The Contrast function changes the differences between light and dark in images during printing. To make the differences between the light and dark portions of images greater and more distinct, increase the contrast. On the other hand, to make the differences between the light and dark portions of images smaller and less distinct, reduce the contrast.

You can also directly enter a value linked to the slider. Enter a value in the range from -50 to 50.

»» Important

- When the **Black and White Photo Print** check box is checked for **Quality & Media**, the color balance (**Cyan**, **Magenta**, **Yellow**) are unavailable.
- If you select **ColorSync** for **Color Matching**, then the color balance (**Cyan**, **Magenta**, **Yellow**), **Tone**, **X**, **Y**, **Brightness**, and **Contrast** appear grayed out and are unavailable.

Related Topics

- [Specifying Color Correction](#)
- [Adjusting Color Balance](#)

■ [Adjusting Brightness](#)

■ [Adjusting Contrast](#)

Paper Detailed Settings

Use this dialog box to set detailed print settings that match the media type loaded on the printer.

If the paper becomes stained during printing or if the quality of the print results is less than expected, using these settings may improve the print results.

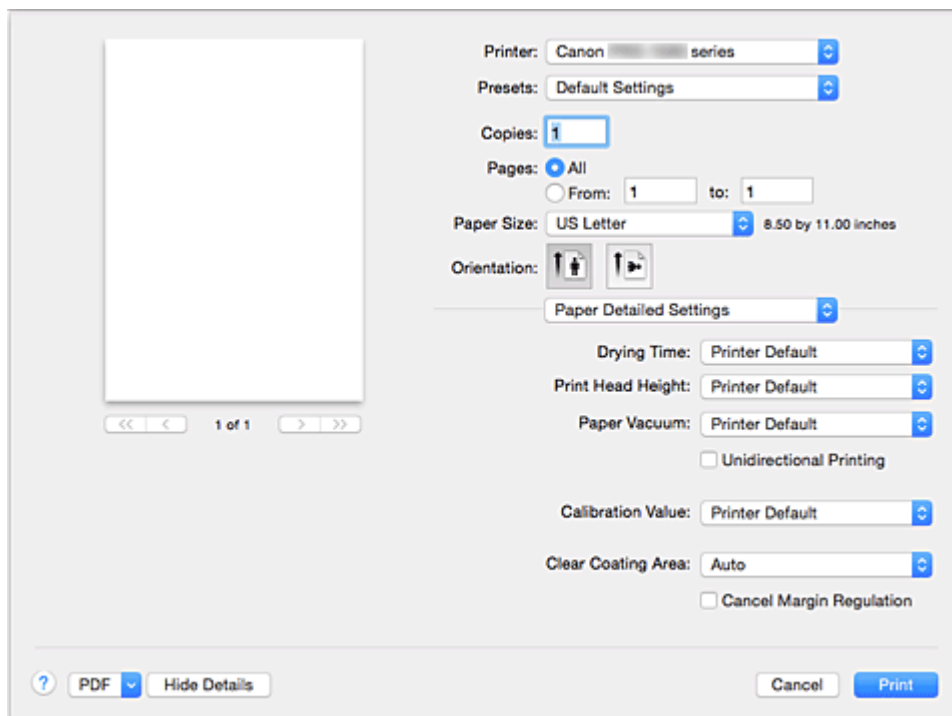

Drying Time

Allows you to set how long the printer rests before printing of the next page starts.

If the next page is ejected before the print surface dries completely and the paper becomes stained, set a longer ink drying wait time.

Print Head Height

Allows you to widen the gap between the print head and the paper to reduce paper abrasion when printing high density pages. To reduce paper abrasion, select **Avoid Paper Abrasion**.

Paper Vacuum

Allows you to change the paper vacuum pressure to be applied during printing.

If stains form on the back surface of the paper when you print on thick paper or paper prone to curling or crinkling, use this function to change the paper vacuum pressure.

Unidirectional Printing

Suppresses uneven coloring and line shifts during printing.

To perform unidirectional printing, check this check box.

Calibration Value

Allows you to apply the results of calibration performed on the printer. To apply calibration values, select **Use Value**.

Clear Coating Area

Set the clear coating area.

Auto

The printer automatically sets the areas to be clear-coated and whether clear coating is to be executed.

It may be possible to reduce the ink consumption of the chroma optimizer (CO) or to accelerate the print speed.

Overall

The printer clear-coats the entire print area.

If selecting **Auto** produced unsatisfactory clear coating effects, selecting **Overall** may improve the results.

Cancel Margin Regulation

Cancels the safety margin regulation when you set **Media Type** to **Photo Paper Pro Premium Matte** or **Matte Photo Paper** from the **Quality & Media** pop-up menu of the print dialog.

When you check this item, the safety margin regulation is canceled, printing in a wider print area and borderless full-page printing become possible, and printing can be performed for all paper sizes.

When the safety margin regulation is canceled, the paper may become smudged or the print quality may drop depending on the paper size used and the environment.

If that happens, we recommend that you print on a paper size that has large margins.

Page Processing

Use this dialog to adjust how much of the document extends outside the paper when full-page borderless printing is used and to specify the stapling side and stapling margin when multiple sheets of paper are being stapled together.

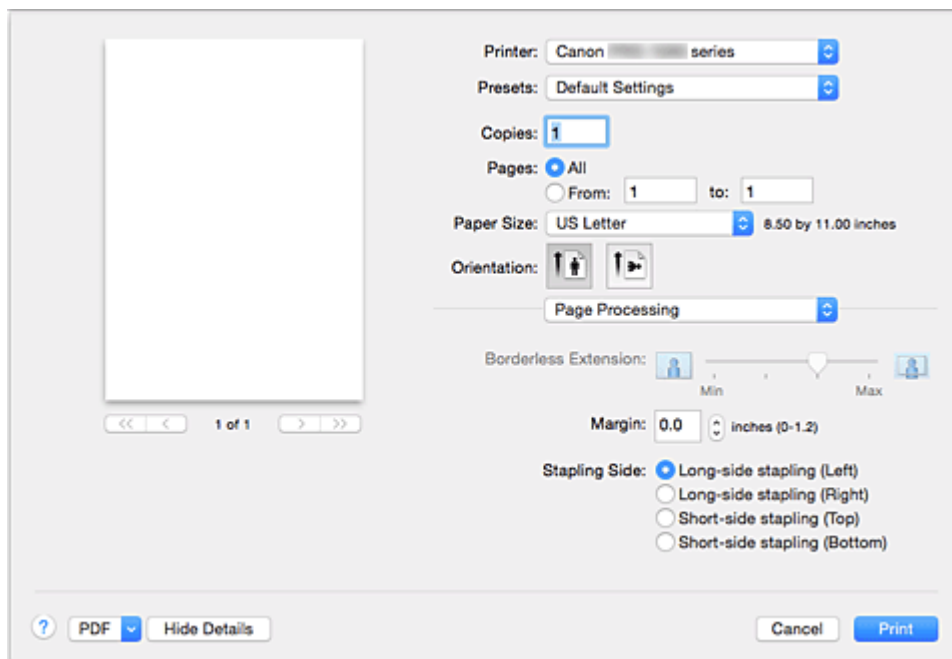

Borderless Extension

Adjusts how much of the document extends outside the paper by using the **Borderless Extension** slider bar.

Drag to slider bar to the right to increase the extension amount, and to the left to decrease the extension amount.

Margin

Sets the margin width for stapling multiple sheets of paper together. Values from 0 mm to 30 mm (0 inch to 1.2 inches) can be entered.

Stapling Side

Sets the side of the paper to be stapled.

Long-side stapling (Left)/Long-side stapling (Right)

Select this when stapling the long side of the paper.

Select either left or right.

Short-side stapling (Top)/Short-side stapling (Bottom)

Select this when stapling the short side of the paper.

Select either top or bottom.

Related Topics

- [Execute Borderless Printing](#)
- [Setting the Stapling Margin](#)

Canon IJ Printer Utility2

The Canon IJ Printer Utility2 allows you to perform printer maintenance or change the settings of the printer.

What You Can Do with the Canon IJ Printer Utility2

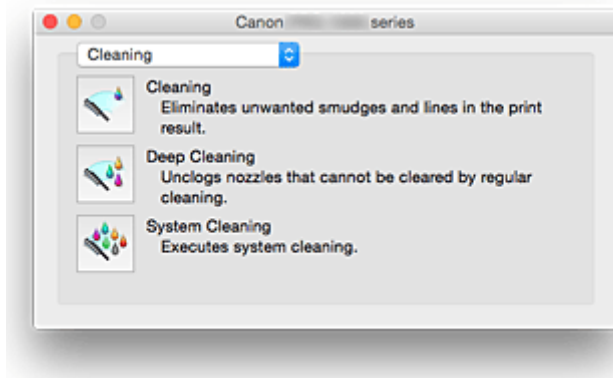

You can switch between pages in Canon IJ Printer Utility2 by the pop-up menu. You can choose one of the following items from the pop-up menu.

Cleaning

Clean the printer to clear up clogged print head nozzle.

Test Print

Conduct a test print to check the condition of the print head nozzle.

Power Settings

Operate the power of this printer from the printer driver.

Quiet Settings

You can reduce the operating noise of the printer.

Custom Settings

Change the settings of this printer.

Media Information

Gets the latest media information from the printer and updates the media information in the printer driver.

Accounting

Allows you to set IDs for each job and each user, and manage the print history and print jobs.

►►► Note

- If the printer is being shared, **Accounting** information cannot be set on client machines.

Ink Level Information

Check the remaining ink levels.

►►► Note

- To operate the Canon IJ Printer Utility2, you must first turn on the printer.
- Depending on the items selected, the computer communicates with the printer to obtain information. If the computer is unable to communicate with the printer, an error message may be displayed. If this happens, click **Cancel** to display the most recent settings specified on your computer.

Opening the Canon IJ Printer Utility2

To open the Canon IJ Printer Utility2, follow the steps below.

1. Open **System Preferences**, and select **Printers & Scanners (Print & Scan)**

2. Start the Canon IJ Printer Utility2

Select your model from the printer list, and click **Options & Supplies...**

Click **Open Printer Utility** in **Utility** tab.

Canon IJ Printer Utility2 is launched.

Changing Printer Settings from Your Computer (Mac OS)

- ▶ **Managing the Printer Power**
- ▶ **Reducing the Printer Noise**
- ▶ **Changing the Printer Operation Mode**
- ▶ **Updating Media Information in Printer Driver**
- ▶ **Correcting Media Information in Printer Driver (When Printer Used in Shared Environment)**
- ▶ **Setting Accounting information**

Managing the Printer Power

This function allows you to manage the printer power from the printer driver.

The procedure for managing the printer power is as follows:



Power Off

The **Power Off** function turns off the printer. When you use this function, you will not be able to turn the printer on from the printer driver.

1. Select **Power Settings** from the pop-up menu on the [Canon IJ Printer Utility2](#)
2. Execute power off

Click **Power Off**, and when the confirmation message appears, click **OK**.

The printer power switches off.



Auto Power

Auto Power allows you to set **Auto Power On** and **Auto Power Off**.

The **Auto Power On** function automatically turns on the printer when data is received.

The **Auto Power Off** function automatically turns off the printer when there are no operations from the printer driver or the printer for a specified period of time.

1. Select **Power Settings** from the pop-up menu on the [Canon IJ Printer Utility2](#)
2. Check that the printer is on, and then click **Auto Power**

A dialog appears.

▶▶ Note

- If the printer is off or if communication between the printer and the computer is disabled, an error message may appear because the computer cannot collect the printer status.

3. If necessary, complete the following settings:

Auto Power On

Specifying **Enable** from the list will turn the printer on upon receipt of print data.

Auto Power Off

Specify the time from the list. When this time lapses without any operations from the printer driver or the printer, the printer is turned off automatically.

4. Apply the settings

The setting is enabled after this. When you want to disable this function, select **Disable** from the list according to the same procedure.

Reducing the Printer Noise

The silent function allows you to reduce the operating noise of this printer. Select when you wish to reduce the operating noise of the printer at night, etc.

Using this function may lower the print speed.

The procedure for using the quiet mode is as follows:

1. Select **Quiet Settings** from the pop-up menu on the [Canon IJ Printer Utility2](#)

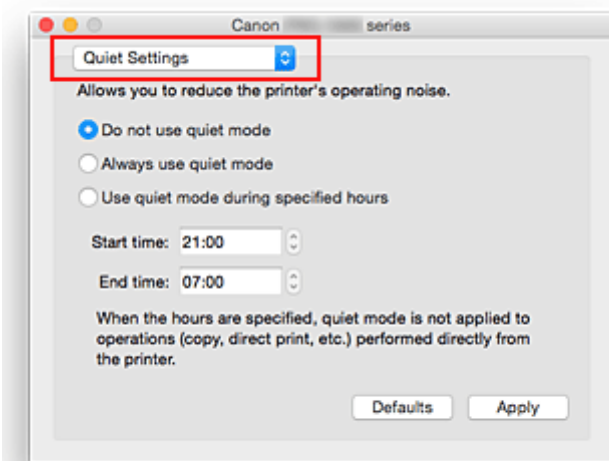

▶▶▶ Note

- If the computer is unable to communicate with the printer, a message may be displayed because the computer cannot access the function information that was set on the printer. If this happens, click **Cancel** to display the most recent settings specified on your computer.

2. Set the quiet mode

If necessary, specify one of the following items:

Do not use quiet mode

Select this option when you wish to use the printer with volume of normal operating noise.

Always use quiet mode

Select this option when you wish to reduce the operating noise of the printer.

Use quiet mode during specified hours

Select this option when you wish to reduce the operating noise of the printer during a specified period of time.

Set the **Start time** and the **End time** of the quiet mode you wish to be activated. If both are set to the same time, the quiet mode will not function.

▶▶▶ Important

- You can set the quiet mode from the operation panel of the printer or the printer driver. No matter how you use to set the quiet mode, the mode is applied when you perform operations from the operation panel of the printer or printing from the computer.
- If you specify a time for **Use quiet mode during specified hours**, quiet mode is not applied to operations (direct print, etc.) performed directly from the printer.

3. Apply the settings

Make sure that the printer is on and click **Apply**.

Click **OK** when the confirmation message appears.

The settings are enabled hereafter.

Note

- The effects of the quiet mode may be less depending on the paper source and the print quality settings.

Changing the Printer Operation Mode

If necessary, switch between various modes of printer operation.

The procedure for configuring **Custom Settings** is as follows:

1. Make sure that the printer is on, and then select **Custom Settings** from the pop-up menu on the [Canon IJ Printer Utility2](#)

▶▶▶ Note

- If the computer is unable to communicate with the printer, a message may be displayed because the computer cannot access the function information that was set on the printer. If this happens, click **Cancel** to display the most recent settings specified on your computer.

2. If necessary, complete the following settings:

Don't detect mismatch of paper settings when printing from computer

When you print documents from your computer and the paper settings on the print dialog and the rear tray paper information registered on the printer do not match, this setting disables the message display and allows you to continue printing.

To disable detection of paper setting mismatches, select this check box.

Disable paper width detection when printing from computer

Even if the paper width identified by the printer during printing from the computer differs from the paper width that was set for **Paper Size** in the print dialog box, this function disables the message display and allows you to continue printing.

To disable detection of the paper width during printing, check this check box.

3. Apply the settings

Click **Apply** and when the confirmation message appears, click **OK**.

The printer operates with the modified settings hereafter.

Updating Media Information in Printer Driver

This function gets the latest media information from the printer and updates the media information in the printer driver.

When the media information is updated, the media displayed for **Media Type** on the **Quality & Media** screen is updated to the latest information.

The procedure for updating media information is described below.



Update Media Information

1. From the [Canon IJ Printer Utility2](#) pop-up menu, select **Media Information**

2. Click **Update Media Information**

A dialog appears.

3. Check that the media information has updated

By following the dialog instructions, check that the printer is on, and then click **OK**.

After checking whether or not the printer media information needs to be updated, a message will be displayed.

If the printer media information is up to date, click **OK** and finish updating media information.

If the information needs to be updated, follow the below steps to do so:

4. Update media information

Check the message and click **Update**.

The printer driver media information will update.

When the authentication screen appears, enter the administrator's name and password, and then click **Install Helper**.

►► Important

- It may take some time to update the media information.
- Do not change media information on the printer while you are updating media information on the driver.

5. Finish updating media information

When a confirmation message appears, click **OK**.

The media information will be updated.

►► Important

- Restart the application or software you are printing from after updating media information.

►► Important

- Ensure that a user with administrator privileges carries out the media information update. Users other than administrators can check if a media information update is required, but cannot carry out the update itself.

- When you have added, deleted, or edited media using administrative tools (the Media Configuration Tool) but have not updated the media information, issues may arise such as the inability to print.

»» Note

- If the printer is being shared, **Correct Media Information** will display on the client machine.
-

Correcting Media Information in Printer Driver (When Printer Used in Shared Environment)

The printer driver media information will be corrected.

Carrying out a media information correction will correct the configuration of the media information in the printer driver.

The procedure for correcting media information is described below.



Correct Media Information

1. From the [Canon IJ Printer Utility2](#) pop-up menu, select **Media Information**

2. Click **Correct Media Information**

After checking whether or not the printer driver's media information is correct, a message will be displayed.

If the printer media information is set correctly, click **OK** and finish correcting media information.

If the information needs to be corrected, follow the below steps to do so:

3. Correct media information

When a confirmation message appears, click **OK**.

The printer driver media information will be corrected.

When the authentication screen appears, enter the administrator's name and password, and then click **Install Helper**.

4. Complete media information correction

When a confirmation message appears, click **OK**.

The paper information will be corrected.

►► Important

- Restart the application or software you are printing from after correcting media information.

►► Note

- **Media Information** will only be displayed on the client machine in use when the printer is being shared.

Setting Accounting information

By setting accounting information, you add IDs to print jobs, and use the printer and cost management tool to tabulate print history information for any ID.

The procedure for setting accounting information is described below.

1. From the [Canon IJ Printer Utility2](#) pop-up menu, select **Accounting**

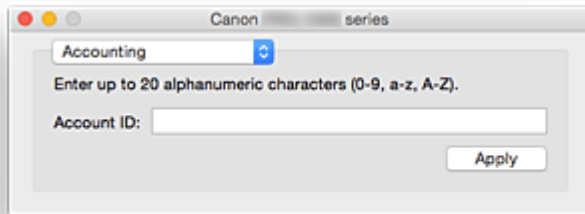

2. Set **Account ID**

Set an Account ID, as necessary.

Account ID

Enter the Account ID to be set. Enter the ID by using up to 20 alphanumeric characters (0 to 9, a to z, A to Z).

3. Apply settings

Check that the printer is on, and then click **Apply**.

When the confirmation message appears, click **OK**.

The setting is now valid.

▶▶▶ Note

- If the printer is being shared, **Accounting** information cannot be set on client machines.

Maintenance of this Printer

- **Cleaning the Print Heads**
- **Printing a Nozzle Check Pattern**
- **Checking the Ink Status from Your Computer**
- **Managing the Printer Power**
- **Reducing the Printer Noise**
- **Changing the Printer Operation Mode**
- **Updating Media Information in Printer Driver**
- **Correcting Media Information in Printer Driver (When Printer Used in Shared Environment)**
- **Setting Accounting information**

Display the Printing Status Screen

Check the print progress according to the following procedure:

1. Launch the printing status screen

- If the print data has been sent to the printer

The printing status screen opens automatically. To display the printing status screen, click the  (the printer icon) displayed on the Dock.

- If the print data has not been sent to the printer

Open **System Preferences**, and select **Printers & Scanners (Print & Scan)**.





To display the printing status screen, select the name of your printer model from the printer list, and then click **Open Print Queue...**

2. Checking the printing status

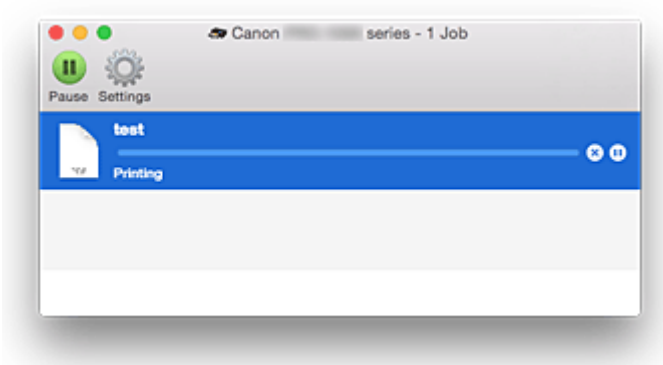
You can check the name of the file being printed or ready for being printed.







- If you are using OS X Yosemite v10.10, OS X Mavericks v10.9, or OS X Mountain Lion v10.8

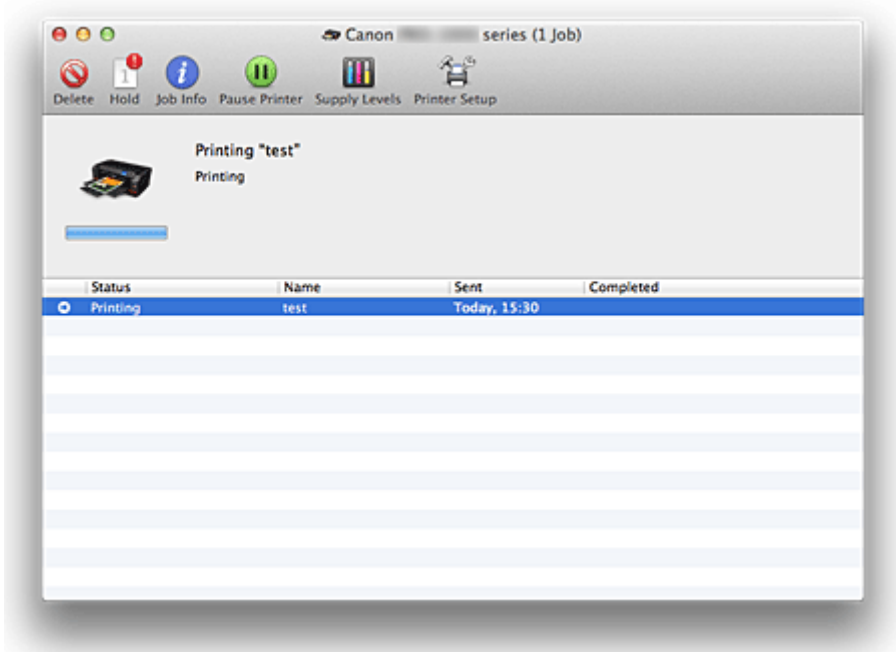

-  Deletes the specified print job.
-  Stops printing the specified document.
-  Resumes printing the specified document.
-  Stops printing all documents.
-  Displayed only when printing of all documents is being stopped, and resumes printing all documents.

- If you are using OS X Lion v10.7



-  Deletes the specified print job.
-  Stops printing the specified document.
-  Resumes printing the specified document.
-  Displays the print job information.
-  Stops printing all documents.
-  Displayed only when printing of all documents is being stopped, and resumes printing all documents.

Deleting the Undesired Print Job

If the printer does not start printing, canceled or failed print job data may be remaining. Delete unnecessary print jobs from the print status check screen.

1. Open **System Preferences**, and select **Printers & Scanners (Print & Scan)**

2. Select your model, and then click **Open Print Queue...**

The print status check screen appears.

3. Select the unnecessary print job and click  ( **Delete**)

The selected print jobs will be deleted.

Instructions for Use (Printer Driver)

This printer driver is subject to the following restrictions. Keep the following points in mind when using the printer driver.

Restrictions on the Printer Driver

- When you set up the Page Setup dialog, be sure to begin by selecting the model you are using from the **Format For** list. If you select another printer, printing may not be performed properly.
- If the Canon IJ Printer Utility2 does not display the remaining ink level in the **Ink Level Information**, check whether the print head and the ink tank are properly installed.
- When the Canon IJ Printer Utility2 displays the **Ink Level Information**, close the cover of the printer.
- The following functions cannot be used in Mac OS, though they can be used in Windows computers.
 - Duplex Printing
 - Booklet Printing
 - Tiling/Poster Printing
- Depending on the application software that you are using, a preview may not be displayed on the left side of the Print dialog.
- Do not start up the Canon IJ Network Tool while printing.
- Do not print when the Canon IJ Network Tool is running.
- If you connect this printer and AirPort with a USB cable and print, you must install the latest AirPort firmware.
- If you are using OS X Mavericks v10.9, close the print status check window when you perform printer maintenance from the Canon IJ Printer Utility2.

Notes on Adding a Printer

- If you will be installing the Canon printer driver on a Mac OS and using the printer through a network connection, select the printer name that contains Bonjour in the **Add (Add Printer)** dialog. If several options are displayed under **Use** in the **Add (Add Printer)** dialog, choose Canon XXX series (where "XXX" is your model name) in order to maximize your ability to control settings during printing.
- If you install a Canon printer driver to OS X Yosemite v10.10 or OS X Mavericks v10.9 and use a USB connection, the **Add (Add Printer)** dialog may display several selections for **Use**. We recommend that you use Canon XXX series (XXX is the model) so that you can specify detailed print settings.

Updating the Printer Driver

- ▶ **Obtaining the Latest Printer Driver**
- ▶ **Delete the Unnecessary Canon IJ Printer from the Printer List**
- ▶ **Before Installing the Printer Driver**
- ▶ **Installing the Printer Driver**

Obtaining the Latest Printer Driver

By updating the printer driver to the latest version of the printer driver, unresolved problems may be solved.

You can access our website and download the latest printer driver for your model.

Important

- You can download the printer driver for free, but any Internet access charges incurred are your responsibility.

Related Topics

- [Before Installing the Printer Driver](#)
- [Installing the Printer Driver](#)

Delete the Unnecessary Canon IJ Printer from the Printer List

A Canon IJ Printer that you no longer use can be deleted from the printer list.

Before deleting the Canon IJ Printer, disconnect the cable that connects the printer to the computer.

The procedure to delete the unnecessary Canon IJ Printer from the printer list is as follows:

You cannot delete the Canon IJ Printer unless you are logged in as a user with the administrative right. For information about an administrative user, refer to the user's manual for the Mac OS.

1. Open **System Preferences**, and select **Printers & Scanners (Print & Scan)**

2. Delete the Canon IJ Printer from the printer list

From the printer list, select the Canon IJ Printer to be deleted, and then click -.

Click **Delete Printer** when the confirmation message appears.

Before Installing the Printer Driver

This section describes the items that you should check before installing the printer driver. You should also refer to this section if the printer driver cannot be installed.

Checking the Personal Computer Settings

- Terminate all running applications.
- Log on as a user who has the administrator account. The installer will prompt you to enter the name and password of the administrative user. When multiple users are using Mac OS, log on with the account of the administrator who registered first.

»» Important

- When you upgrade Mac OS, all printer drivers that were installed will be deleted. If you plan to continue using this printer, re-install the latest printer driver.

Related Topics

- [Obtaining the Latest Printer Driver](#)
- [Installing the Printer Driver](#)

Installing the Printer Driver

You can access our web site through the Internet and download the latest printer driver for your model.

The procedure for installing the downloaded printer driver is as follows:

1. Mount the disk

Double-click the disk image file you have downloaded.
The file is unpacked, and then the disk is mounted.

2. Start the installer

Double-click "PrinterDriver_XXX_YYY.pkg" (where "XXX" is your model name, and "YYY" is version) contained in the disk.

3. Start the installation

Install the printer driver according to the messages on the screen.

When the Software License Agreement is displayed, check the contents, and click **Continue**. If you do not agree to the terms of the Software License Agreement, you cannot install this software.

4. Selecting the install destination

If necessary, select where you want to install the printer driver, and then click **Continue**.

5. Executing the installation

Click **Install**.

When the authentication screen is displayed, enter the name and password of the administrator, and then click **Install Software**.

6. Complete the installation

When the completion message appears, click **Close**.

The printer driver is installed successfully.

Important

- If the Installer does not operate properly, select **Quit Installer** from the **Installer** menu of the Finder to quit the Installer. Then start the Installer again.
- You can download the printer driver for free, but you are responsible for paying any connection fees to the Internet.

Related Topics

- [Obtaining the Latest Printer Driver](#)
- [Delete the Unnecessary Canon IJ Printer from the Printer List](#)
- [Before Installing the Printer Driver](#)

Sharing the Printer on a Network

When multiple computers are being used in the network environment, you can share the printer connected to one computer with the other computers.

Before carrying out the setup for printer sharing, select **Network** from **System Preferences**, and check whether the network settings have been set.

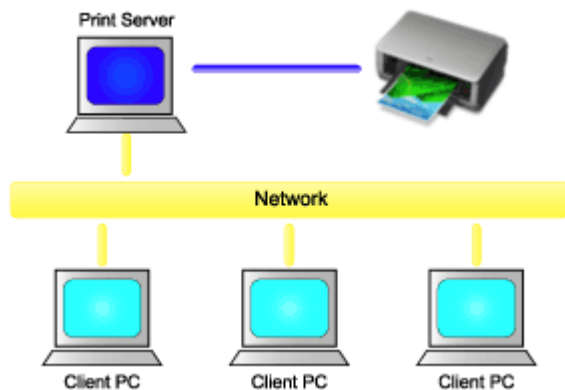

This section describes the procedure for sharing a printer among Mac.

- [Settings on Print Server](#)

This section describes how to set up a computer that connects with this printer.

- [Settings on Client PC](#)

This section describes the procedure for setting a computer that uses this printer through a network.

When you execute print, the data is sent to the printer through the print server system.

Related Topic

- [Restrictions on Printer Sharing](#)

Settings on Print Server

When you use the printer on a network, set up the printer driver for sharing on the print server system.

The procedure for setting up the print server systems is as follows:

1. [Install the printer driver](#) on the print server system

2. Check that the printer to be used has been added

Open **System Preferences**, and select **Printers & Scanners (Print & Scan)**.

The printer list displays the printers that are connected to the computer.

3. Set sharing

Check the **Share this printer on the network** check box.

Note

- Depending on the environment you are using, a message prompting you to restart the computer may be displayed. To complete the installation properly, restart the computer.

The setup on the print server system is complete. Next, set up the client systems.

Settings on Client PC

After setting up the print server system, set up the client system.

The procedure for setting up the client systems is as follows:

1. [Install the printer driver](#) on the client systems

2. Display the printer list

Open **System Preferences**, and select **Printers & Scanners (Print & Scan)**.
Click **+** to display the printer list.

3. Add a printer to be shared

Select a shared printer displayed in the printer list, and then click **Add**.

The setup on the client systems is now completed.

▶▶▶ Note

- The print procedures are the same as when the computer is connected directly to the printer with a USB cable.
At the Page Setup dialog, select the printer that is connected to the print server to be used.

Restrictions on Printer Sharing

These are restrictions that apply when you are using a printer in a network environment.

- Install the same version of the printer driver in the print server system and the client systems. You can download the latest printer driver from our web site.
- Use printer sharing with users who have the administrator privilege.
- Depending on how the computer is connected with the printer, the computer may not be able to access the function information that was set on the printer and display the correct settings.
- Media information on the printer driver cannot be changed when using a client machine.

Printing Using Canon Application Software

- ▶ **My Image Garden Guide**
- ▶ **Print Studio Pro Guide**
- ▶ **Digital Photo Printing Guide**
- ▶ **Quick Utility Toolbox Guide**
- ▶ **Device Management Console Guide**
- ▶ **Accounting Manager Guide**

My Image Garden Guide

You can learn about the operations and screens of My Image Garden.



For Windows:

Latest Version

My Image Garden V3.3.x/V3.2.x

It is recommended that you use the latest version of the application.

Access the Canon website and download the latest application.

[How to Check the Version](#) ▶

Earlier Versions

Select the version of your My Image Garden.

- V3.1.x/V3.0.x
- V2.1.x
- V2.0.x
- V1.1.x

For Mac OS:

Latest Version

My Image Garden V3.3.x/V3.2.x

It is recommended that you use the latest version of the application.

Access the Canon website and download the latest application.

[How to Check the Version](#) ▶

Earlier Versions

Select the version of your My Image Garden.

- V3.1.x/V3.0.x
- V2.1.x
- V2.0.x
- V1.1.x

Print Studio Pro Guide

You can learn about the operations and screens of Print Studio Pro.



For Windows:

Latest Version

Print Studio Pro V2.0.x

It is recommended that you use the latest version of the application.

Access the Canon website and download the latest application.

- Print Studio Pro V2.0.0 or later is not available when using Pro9500 Mark II series or Pro9000 Mark II series.
- When using PRO-1 series, you need to upgrade the printer driver and other software to the latest versions to use Print Studio Pro V2.0.x.

[How to Check the Version](#) ▶

Earlier Versions

Select the version of your Print Studio Pro.

- V1.4.x
- V1.3.6/V1.3.5
- V1.3.0
- V1.2.x

For Mac OS:

Latest Version

Print Studio Pro V2.0.x

It is recommended that you use the latest version of the application.

Access the Canon website and download the latest application.

- Print Studio Pro V2.0.0 or later is not available when using Pro9500 Mark II series or Pro9000 Mark II series.
- When using PRO-1 series, you need to upgrade the printer driver and other software to the latest versions to use Print Studio Pro V2.0.x.

[How to Check the Version](#) ▶

Earlier Versions

Select the version of your Print Studio Pro.

- V1.4.x

■ V1.3.6/V1.3.5

■ V1.3.0

■ V1.2.x

I want to keep my precious photos beautiful. I want to transform photos into works of art as I wish.
To make such wishes come true,
master printing techniques that maximize the printer's performance!



- Lesson 1 Digital Printing Workflow Explains the basic printing procedure for producing beautiful photos as you wish
- Lesson 2 Color Management Basics Explains the basic knowledge of color management that is essential to maximizing the printer's performance and to producing rewarding photos
- Lesson 3 Utilizing Print Studio Pro By using Print Studio Pro, you can perform various printing tasks more easily by fully utilizing the information captured with a digital camera
- Lesson 4 Techniques for Specific Objectives By simply applying a little technique, you can achieve the impression you want to represent
- Appendix Useful Information Describes the information that is useful to know, such as types of ink and media (paper)

Quick Utility Toolbox Guide

You can learn about the operations and screens of Quick Utility Toolbox.



For Windows:

Latest Version

Quick Utility Toolbox V2.0.x

It is recommended that you use the latest version of the application.

Access the Canon website and download the latest application.

[How to Check the Version](#) ▶

For Mac OS:

Latest Version

Quick Utility Toolbox V2.0.x

It is recommended that you use the latest version of the application.

Access the Canon website and download the latest application.

[How to Check the Version](#) ▶

Media Configuration Tool Guide

You can learn about the operations and screens of Media Configuration Tool.

For Windows:

Latest Version

Media Configuration Tool V1.0.x

It is recommended that you use the latest version of the application.

Access the Canon website and download the latest application.

Device Management Console Guide

You can learn about the operations and screens of Device Management Console.

For Windows:

Latest Version

Device Management Console V1.0.x

It is recommended that you use the latest version of the application.

Access the Canon website and download the latest application.

For Mac OS:

Latest Version

Device Management Console V1.0.x

It is recommended that you use the latest version of the application.

Access the Canon website and download the latest application.

Accounting Manager Guide

You can learn about the operations and screens of Accounting Manager.

For Windows:

Latest Version

Accounting Manager V1.0.x

It is recommended that you use the latest version of the application.

Access the Canon website and download the latest application.

For Mac OS:

Latest Version

Accounting Manager V1.0.x

It is recommended that you use the latest version of the application.

Access the Canon website and download the latest application.

iOS Software

- ▶ **Pro Gallery Print**
- ▶ **Canon PRINT Inkjet/SELPHY**

Browse/Print Photo Items Using Pro Gallery Print

Pro Gallery Print is a dedicated iPad app developed for the PRO series. This is an application that allows you to browse/print photo items from an iPad even from remote locations through integration with web services for professionals.

Pro Gallery Print is available for free from App Store.



►► Important

- Download requires registration for an App Store account.
- The application can be downloaded for free; however, transmission fees for connecting to App Store apply.
- Download is not possible if your operating system environment does not support the application. The application download page may not appear as well.

Print Easily from a Smartphone or Tablet with Canon PRINT Inkjet/SELPHY

Use Canon PRINT Inkjet/SELPHY to easily print photos saved on a smartphone or tablet (iOS or Android) wirelessly.

Canon PRINT Inkjet/SELPHY can be downloaded from App Store and Google Play.



Print Easily from a Smartphone or Tablet with Canon PRINT Inkjet/SELPHY

Use Canon PRINT Inkjet/SELPHY to easily print photos saved on a smartphone or tablet (iOS or Android) wirelessly.

Canon PRINT Inkjet/SELPHY can be downloaded from App Store and Google Play.



Troubleshooting

Frequently Asked Questions

- [Cannot Find Printer on Network](#)
- [Cannot Find Printer while Using Wireless LAN](#)
- [Printing Does Not Start](#)
- [Paper Is Blank/Printing Is Blurry/Colors Are Wrong/White Streaks Appear](#)
- [An Error Occurs](#)
- [Print Results Are Unsatisfactory](#)
- [Message Appears](#)
- [Cannot Install Printer Driver](#)
- [Network Key Unknown](#)
- [Paper Jams](#)

Examples of Problems

- **Printer Does Not Move**
 - [Power Does Not Come On](#)
 - [Power Shuts Off By Itself](#)
 - [Printer Suddenly Cannot Be Used](#)
 - [Printing Does Not Start](#)
 - [Paper Jams](#)
 - [Cannot Print from Smartphone/Tablet](#)
- **Cannot Set Correctly**
 - [Cannot Find Printer on Check Printer Settings Screen \(Windows\)](#)
 - [Message Appears on Computer During Setup](#)
 - [Cannot Find Printer while Using Wireless LAN](#)
 - [Cannot Find Printer while Using Wired LAN](#)
 - [USB Connection Problems](#)
 - [Cannot Communicate with Printer via USB](#)
 - [Network Key Unknown](#)
 - [Printer Cannot Be Used After Replacing Wireless Router or Changing Its Settings](#)
 - [Administrator Password Set for Printer Unknown](#)
 - [Checking Network Information](#)
 - [Restoring to Factory Defaults](#)
 - [Cannot Install Printer Driver](#)
 - [Easy-WebPrint EX Does Not Start or Easy-WebPrint EX Menu Does Not Appear \(Windows\)](#)
 - [Updating Printer Driver in Network Environment \(Windows\)](#)
- **Print Results Are Unsatisfactory**
 - [Printing Does Not Start](#)
 - [Printing Is Slow](#)
 - [Printing Stops](#)
 - [Print Results Are Unsatisfactory](#)
 - [No Ink Comes Out](#)

- [Paper Jams](#)
- [Paper Does Not Feed Properly/"No Paper" Error](#)
- **Error or Message Appears**
 - [An Error Occurs](#)
 - [LCD Is Off](#)
 - [LCD Shows Wrong Language](#)
 - [Message Appears](#)
 - [List of Support Code for Error](#)
 - [Error Message Appears on PictBridge \(Wireless LAN\) Compliant Device](#)

Operation Problems

- [Network Communication Problems](#)
- [Printing Problems](#)
- [Problems while Printing from Smartphone/Tablet](#)
- [Mechanical Problems](#)
- [Installation and Download Problems](#)
- [Errors and Messages](#)
- [If You Cannot Solve a Problem](#)



Power Does Not Come On



Check1 Press **ON** button.

Check2 Make sure power plug is securely connected to printer, and then turn it back on.

Check3 Unplug printer, leave it for at least 3 minutes, and then plug it back in and turn it on again.

If this does not solve the problem, contact your nearest Canon service center to request a repair.



Printing Does Not Start



Check1 Make sure printer is securely plugged in and press **ON** button to turn it on.

The **POWER** lamp flashes while the printer is initializing. Wait until the **POWER** lamp stops flashing and remains lit.

▶▶▶ Note

- If you are printing large data such as photos or other graphics, printing may take longer to start. The **POWER** lamp flashes while the computer is processing data and sending it to the printer. Wait until printing starts.

Check2 If printer is turned off for some time, it may take longer to start printing.

Wait until printing starts.

Check3 Make sure printer is properly connected to computer.

If you are using a USB cable, make sure it is securely connected to both the printer and the computer. When the USB cable is securely plugged in, check the following:

- If you are using a relay device such as a USB hub, disconnect it, connect the printer directly to the computer, and retry the printing. If printing starts normally, there is a problem with the relay device. Contact the vendor of the relay device.
- There could also be a problem with the USB cable. Replace the USB cable and retry the printing.

If you use the printer over a LAN, make sure the printer is connected to the network with a LAN cable or is correctly set up for network use.

Check4 Is direct connection enabled?

To print using a mode other than the direct connection, disable the direct connection first.

■ [Using Printer with Direct Connection](#)

Check5 Make sure paper settings match information set for rear tray.

If the paper settings do not match the information set for the rear tray, an error message appears on the LCD. Follow the instructions on the LCD to solve the problem.

■ [Paper Settings](#)

▶▶▶ Note

- You can select whether the message which prevents misprinting is displayed.
 - To change the message view setting when printing using the printer's operation panel:
 - [Paper-related settings](#)
 - To change the message view setting when printing using the printer driver:
 - [Changing the Printer Operation Mode \(Windows\)](#)

Check6 If printing from a computer, delete unnecessary print jobs.

- For Windows:

■ [Deleting the Undesired Print Job](#)

- For Mac OS:

■ [Deleting the Undesired Print Job](#)

Check7 Is feed slot cover closed?

If the feed slot cover is opened, close it slowly and press the **OK** button.

Check8 Is manual feed tray in paper feed position?

If the manual feed tray is in the paper jam clearing position, return the tray to the paper feed position and press the **OK** button on the printer.

Check9 Is tank cover closed?

If the tank cover is opened when printing, close it.

Check10 Does page size setting match size of paper loaded in printer?

- For Windows:

Press the **OK** button on the printer to clear the error. Then check **Page Size** setting in **Page Setup** sheet of the printer driver and load paper that is the same size as the setting and try printing again.

Set the printer not to detect the width of the paper using the printer driver.

To set the printer not to detect the width of the paper, open the printer driver setup window, and in **Custom Settings** under **Maintenance** sheet, select **Disable paper width detection when printing from computer** check box, and then click **OK**.

To open the printer driver setup window, see [How to Open the Printer Driver Setup Window](#).

* Clear **Disable paper width detection when printing from computer** check box again once printing is complete, and then click **OK**.

- For Mac OS:

Press the **OK** button on the printer to clear the error. Then check the **Paper Size** setting in the Page Setup dialog and load paper that is the same size as the setting and try printing again.

Set the printer not to detect the width of the paper using the Canon IJ Printer Utility.

To set the printer not to detect the width of the paper, open the Canon IJ Printer Utility, select **Custom Settings** in the pop-up menu, select **Disable paper width detection when printing from computer** check box, and then click **Apply**.

To open the Canon IJ Printer Utility, see [Opening the Canon IJ Printer Utility](#).

* Clear the **Disable paper width detection when printing from computer** check box again once printing is complete, and then click **Apply**.

Check11 Are media type and paper size specified properly in the printer driver?

When the media type is specified to **Photo Paper Pro Premium Matte** or **Matte Photo Paper** in the printer driver, specify a paper size from the following size that has wide margins.

- **A4 (Margin 25)**
- **Letter (Margin 25)/US Letter (Margin 25)**
- **A3 (Margin 25)**
- **A3+ (Margin 25)**
- **A2 (Margin 25)**
- **17"x22" (Margin 25)/C (Margin 25)**

▶▶▶ Important

- By canceling the safety margin regulation with the following method, you can print with normal paper size.
 - For Windows:

Click **Print Options** on **Page Setup** sheet of the printer driver. Then select **Cancel the safety margin regulation for paper size** check box in the dialog that appears.
 - For Mac OS:

Select **Cancel Margin Regulation** check box in **Paper Detailed Settings** in the Print dialog.

If you print with normal paper size, conditions such as paper abrasion may cause paper stains or deterioration of print quality depending on the environment. We recommend that you print with a paper size that has wide margins.

Check12 Is your printer's printer driver is selected when printing?

The printer will not print properly if you are using a printer driver for a different printer.

- For Windows:

Make sure "Canon XXX series" (where "XXX" is your printer's name) is selected in the Print dialog box.

▶▶▶ Note

- To make the printer the one selected by default, select **Set as Default Printer**.

- For Mac OS:

Make sure your printer's name is selected in **Printer** in the Print dialog.

▶▶▶ Note

- To make the printer the one selected by default, select the printer for **Default printer**.

Check13 Set correct printer port. (Windows)

Make sure the correct printer port is set.

1. Log in using an account with administrator privileges.
2. Make the following settings.
 - In Windows 8.1 or Windows 8, select **Control Panel** from **Settings** charm on **Desktop > Hardware and Sound > Devices and Printers**.
 - In Windows 7, select **Devices and Printers** from **Start** menu.
 - In Windows Vista, select **Start** menu > **Control Panel > Hardware and Sound > Printers**.
3. Open printer driver properties.
 - In Windows 8.1, Windows 8, or Windows 7, right-click "Canon XXX series" icon (where "XXX" is your printer's name), and then select **Printer properties**.

- In Windows Vista, right-click "Canon XXX series" icon (where "XXX" is your printer's name), and then select **Properties**.

4. Click **Ports** tab to check port settings.

Make sure a port named "USBnnn" (where "n" is a number) with "Canon XXX series" appearing in **Printer** column is selected for **Print to the following port(s)**.

- If setting is incorrect:

Reinstall the printer driver from the Setup CD-ROM or the Canon website.

- Printing does not start even though the printer is connected to the computer using a USB cable and the port named "USBnnn" is selected:

In Windows 8.1 or Windows 8, select **My Printer** on **Start** screen to start **My Printer**. If **My Printer** is not displayed on **Start** screen, select **Search** charm, and then search for "**My Printer**".

Set the correct printer port on **Diagnose and Repair Printer**. Follow the on-screen instructions to set the correct printer port, and then select your printer's name.

In Windows 7 or Windows Vista, click **Start** and select **All programs, Canon Utilities, Canon My Printer, Canon My Printer**, and then select **Diagnose and Repair Printer**. Follow the on-screen instructions to set the correct printer port, and then select your printer's name.

If the problem is not resolved, reinstall the printer driver from the Setup CD-ROM or the Canon website.

Check14 Is print data extremely large? (Windows)

Click **Print Options** on **Page Setup** sheet of the printer driver. Then make sure **Prevention of Print Data Loss** is set to **On (Weak)** in the dialog that appears.

If printing does not start even though **Prevention of Print Data Loss** is set to **On (Weak)**, set it to **On (Strong)** and start printing again.

* This may reduce print quality.

Check15 If printing from your computer, restart computer.



Paper Does Not Feed Properly/"No Paper" Error



Check1 Make sure paper is loaded.

[Handling Paper](#)

Check2 When loading paper, consider the following.

- When loading two or more sheets of paper, flip through the paper before loading.



- When loading two or more sheets of paper, align the edges of the sheets before loading the paper.
- When loading two or more sheets of paper, make sure the paper stack does not exceed the paper load limit.

However, paper may not feed correctly at the maximum capacity, depending on the type of paper or environmental conditions (very high or low temperature and humidity). In such cases, reduce the amount of paper you load at a time to less than half of the paper load limit.

- Always load the paper in portrait orientation, regardless of the printing orientation.

In the manual feed tray:

When you load the paper, load one sheet at a time. When you print continuously, set the next paper after the last one is finished printing.

Check3 Is paper too thick or curled?

[Media Types You Cannot Use](#)

Check4 When loading postcards, consider the following:

- If a postcard is curled, it may not feed properly even though the paper stack does not exceed the paper load limit.

Load Japanese postcards with their postcode column downward.

Check5 Check paper source setting.

[Switching the Paper Source to Match the Purpose](#)

Check6 Make sure paper weight is suitable for use with printer.

[Media Types You Can Use](#)

Check7 Make sure there are not any foreign objects in rear tray or manual feed tray.



If the paper tears in the rear tray or the manual feed tray, see [Paper Jams](#) to remove it.

If there are any foreign objects in the rear tray or manual feed tray, be sure to turn off the printer, unplug it and remove the foreign object.



▶▶▶ Note

- If the feed slot cover is opened, close it slowly.

Check8 Clean paper feed roller.

■ [Cleaning the Paper Feed Roller](#)

▶▶▶ Note

- Cleaning the paper feed roller abrades it, so do this only when necessary.

If the measures above do not solve the problem, contact your nearest Canon service center to request a repair.



Print Results Are Unsatisfactory



If the print results are unsatisfactory due to white streaks, misaligned lines, or uneven colors, check the paper and print quality settings first.

Check1 Do page size and media type settings match size and type of loaded paper?

If these settings do not match, it is not possible to obtain the proper result.

If you are printing a photograph or an illustration, an incorrect paper type setting may reduce the quality of the printout color.

Also, if you print with an incorrect paper type setting, the printed surface may be scratched.

In borderless printing, uneven coloring may occur depending on the combination of the paper type setting and the loaded paper.

The method for checking the paper and print quality settings differs depending on what you are using your printer for.

Printing from a PictBridge (Wireless LAN) compliant device	<p>Check the settings on your PictBridge (Wireless LAN) compliant device.</p> <ul style="list-style-type: none"> ■ PictBridge (Wireless LAN) Print Settings <p>Check the settings using the operation panel.</p> <ul style="list-style-type: none"> ■ PictBridge print settings
Printing from your computer	<p>Check the settings using the printer driver.</p> <ul style="list-style-type: none"> ■ Printing with Easy Setup

Check2 Make sure appropriate print quality is selected (see table above).

Select a print quality suited to the paper and to what you are printing. If you notice blurs or uneven colors, increase the print quality setting and retry the printing.

▶▶▶ Note

- When printing from a PictBridge (Wireless LAN) compliant device, set the print quality setting using the operation panel.

This setting cannot be made on the PictBridge (Wireless LAN) compliant device.

Check3 When using wireless LAN, make sure radio status is good.

■ Checking Wireless Network Status

If the radio status is poor, it may be possible that print results are not satisfactory or the printing speed is slow. Retry printing after the radio status improves.

If the problem is not resolved even after the radio status improves, use the printer via USB or a wired LAN.

Check4 If problem is not resolved, check other causes.

See also the sections below:

- ■ [Cannot Complete Printing](#)
- ■ [Paper Is Blank/Printing Is Blurry/Colors Are Wrong/White Streaks Appear](#)
- ■ [Lines Are Misaligned](#)
- ■ [Lines Incomplete or Missing \(Windows\)](#)
- ■ [Images Incomplete or Missing \(Windows\)](#)
- ■ [Ink Blots / Paper Curl](#)
- ■ [Paper Is Smudged / Printed Surface Is Scratched](#)
- ■ [Back of Paper Is Smudged](#)
- ■ [Vertical Line Next to Image](#)
- ■ [Uneven or Streaked Colors](#)
- ■ [Small Dots of Ink Adheres to Margins of Paper](#)
- ■ [Printed Colors Are Inaccurate](#)
- ■ [Documents Are Printed in Monochrome](#)



No Ink Comes Out



Check1 Has ink run out?

■ [Checking the Ink Status with the LCD on the Printer](#)

Check2 Are print head nozzles clogged?

Print the nozzle check pattern to determine whether the ink ejects properly from the print head nozzles.

For details on printing the nozzle check pattern, print head cleaning, print head deep cleaning, and system cleaning, see [Maintenance Procedure](#).

- If nozzle check pattern is not printed correctly:

Check if the ink tank for the problem color is empty.

If the ink tank is not empty, perform print head cleaning and try printing the nozzle check pattern again.

- If problem is not resolved after performing print head cleaning twice:

Perform print head deep cleaning.

- If problem is not resolved after performing print head deep cleaning:

Perform system cleaning manually.

If the problem is not resolved after performing the system cleaning manually, perform the print head deep cleaning after 24 hours later. If the problem is not resolved yet, the print head may be damaged. Contact your nearest Canon service center to request a repair.

▶▶▶ Note

- If you use the printer in the highlands, the blurs and the streaks may appear on the print result at regular intervals (about 2 to 3 months) by barometric effects. To prevent blur and streak, set **System cleaning frequency** to **Short** on the printer's operation panel.

System cleaning consumes many ink. Set **System cleaning frequency** to **Short** if necessary.



Paper Jams



When paper jams, a troubleshooting message appears automatically. Take the appropriate action described in the message.

- **When a Support Code and a Message Are Displayed on Computer Screen:**

- For Windows:

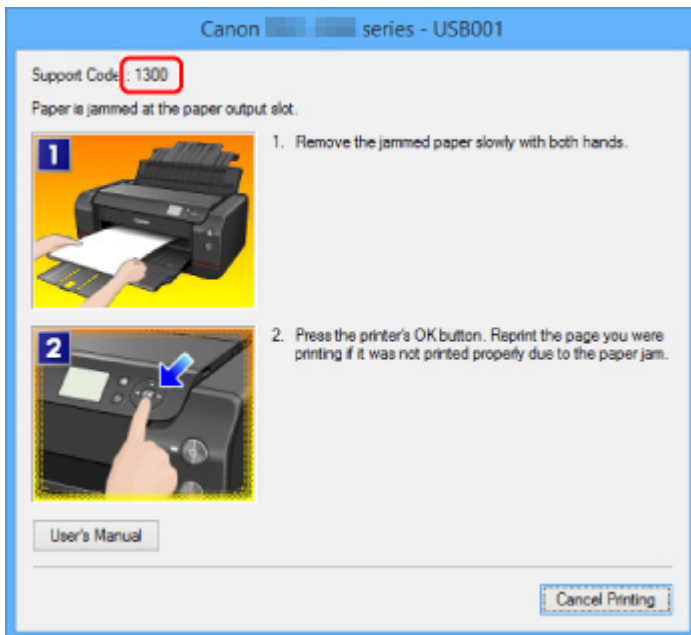

- For Mac OS:

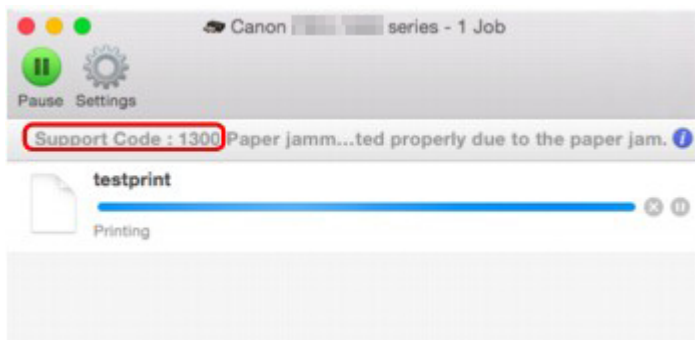

* The screen differs depending on the OS you are using.

- When a Support Code and a Message Are Displayed on LCD:

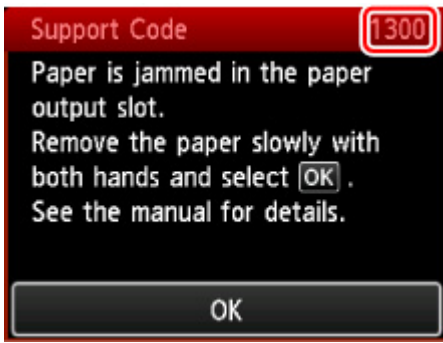

To remove the jammed paper, see [List of Support Code for Error \(Paper Jams\)](#).

▶▶▶ Note

- You can also search for details on resolving the errors indicated by the support code shown.

■ [Search](#)

An Error Occurs

If an error occurs in printing, for example if the paper runs out or jams, a troubleshooting message appears automatically. Take the appropriate action described in the message.

If an error occurs, a support code (error number) appears on the computer screen or the LCD.

When a Support Code and a Message Are Displayed on Computer Screen:

- For Windows:

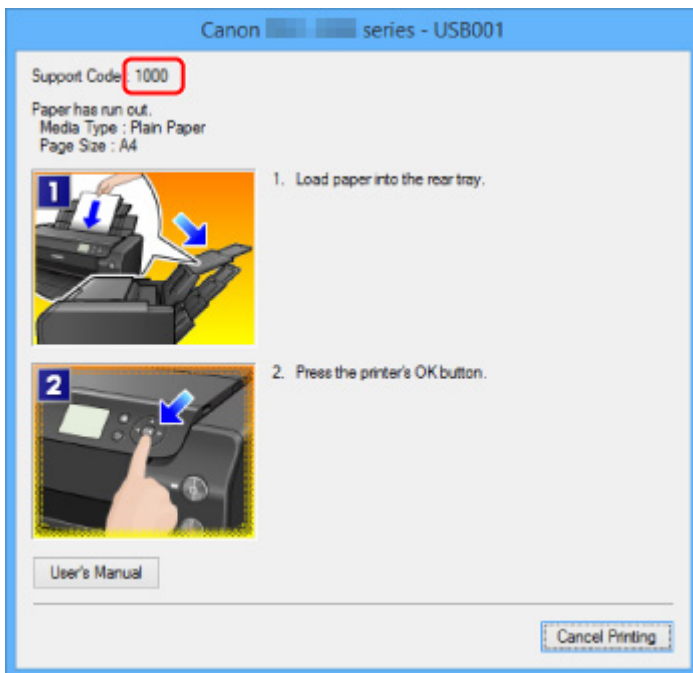

- For Mac OS:

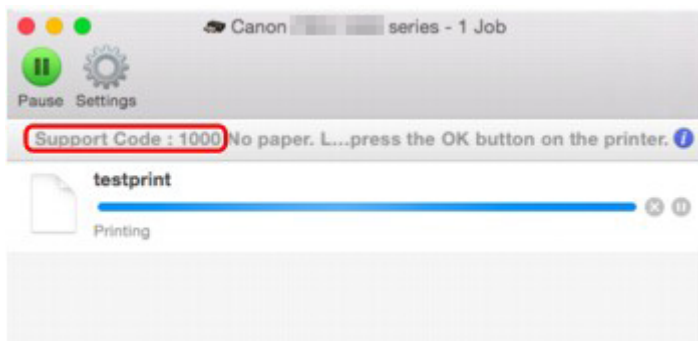

* The screen differs depending on the OS you are using.

When a Support Code and a Message Are Displayed on LCD:

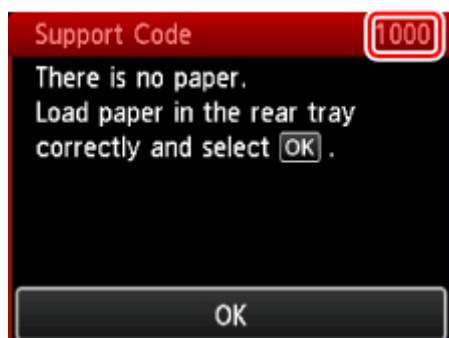

For more on resolving errors with support codes, see [List of Support Code for Error](#).

▶▶ Note

- You can also search for details on resolving the errors indicated by the support code shown.

■ [Search](#)

To resolve errors that do not have support codes, see [Message Appears](#).

List of Support Code for Error

Support code appears on the LCD and your computer screen when errors occur.

A "support code" is an error number, and appears along with an error message.

When an error occurs, check the support code displayed on the LCD and computer screen and take the appropriate action in response.

Support Code Appears on LCD and Computer Screen

- **1000 to 1ZZZ**

[1000](#) [1006](#) [1062](#) [1200](#) [1201](#) [1204](#)

[1205](#) [1206](#) [1207](#) [1208](#) [1209](#) [1250](#)

[1261](#) [1270](#) [1293](#) [1300](#) [1340](#) [1401](#)

[1403](#) [1405](#) [1406](#) [1407](#) [1408](#) [1409](#)

[140A](#) [140B](#) [140C](#) [140D](#) [140E](#) [140F](#)

[1410](#) [1411](#) [1412](#) [1413](#) [1414](#) [1415](#)

[1416](#) [1417](#) [1418](#) [1419](#) [141A](#) [141B](#)

[1466](#) [1467](#) [1491](#) [1493](#) [1551](#) [1552](#)

[1600](#) [1660](#) [1681](#) [1684](#) [1720](#) [1721](#)

[1722](#) [1730](#) [1731](#) [1751](#) [1752](#) [1753](#)

[1880](#) [1881](#) [1890](#)

- **2000 to 2ZZZ**

[2102](#) [2103](#) [2114](#) [2123](#) [2500](#) [2501](#)

[2502](#) [2503](#)

- **3000 to 3ZZZ**

[3000](#) [3250](#) [3306](#) [3310](#) [3311](#) [3312](#)

[3313](#) [3314](#) [3315](#) [3316](#) [3317](#) [3318](#)

[3319](#) [3413](#)

- **4000 to 4ZZZ**

[4100](#) [4103](#) [4109](#) [4111](#)

- **5000 to 5ZZZ**

[5100](#) [5110](#) [5200](#) [520A](#) [520B](#) [520C](#)

[520D](#) [5250](#) [5400](#) [5403](#) [5700](#) [5701](#)

[5B16](#) [5C00](#) [5C01](#) [5C10](#) [5C11](#) [5C12](#)

[5C13](#) [5C14](#) [5C20](#)

• **6000 to 6ZZZ**

[6000](#) [6500](#) [6502](#) [6700](#) [6701](#) [6800](#)

[6801](#) [6900](#) [6901](#) [6902](#) [6910](#) [6911](#)

[6920](#) [6921](#) [6930](#) [6931](#) [6932](#) [6933](#)

[6940](#) [6941](#) [6942](#) [6943](#) [6944](#) [6945](#)

[6946](#) [6F00](#)

• **7000 to 7ZZZ**

[7400](#) [7401](#) [7402](#)

• **8000 to 8ZZZ**

[8100](#) [8200](#)

• **A000 to ZZZZ**

[B202](#) [B203](#) [B204](#) [B205](#) [B206](#) [B207](#)

[B208](#) [B209](#) [B400](#) [B505](#) [B506](#) [B507](#)

[B600](#) [B801](#) [B802](#)

For paper jam support codes, see also [List of Support Code for Error \(Paper Jams\)](#).

Network Communication Problems

- ▶ **Cannot Find Printer on Network**
- ▶ **Network Connection Problems**
- ▶ **Other Network Problems**

Cannot Find Printer on Network

While performing printer setup:

The firewall of your security software or operation system for computer may limit communication between the printer and your computer. Check the firewall setting of your security software or operation system or the message shown on your computer.

- **If message appears:**

If a message appears warning that Canon software is attempting to access the network, set the security software to allow access.

- **If no message appears:**

Cancel the setup, and then set the security software to allow Canon software below to access the network.

- For Windows:

Setup.exe or **Setup64.exe** in the **win > Driver > DrvSetup** folder on the Setup CD-ROM

- For Mac OS:

Setup.app, **canonijnetwork.bundle**, **cnwidsd.plugin**, and **cnwidss.plugin**

▶▶▶ Note

- For more on firewall settings of your operating system or security software, see instruction manual or contact its manufacturer.

- ▶ [Cannot Find Printer on Check Printer Settings Screen \(Windows\)](#)
- ▶ [Cannot Find Printer on Select Printer Screen](#)
- ▶ [Searching Printer by IP Address or Host Name During Setup](#)
- ▶ [Cannot Proceed beyond Printer Connection Screen](#)

While using printer:

- ▶ [Cannot Find Printer while Using Wireless LAN](#)
- ▶ [Cannot Find Printer while Using Wired LAN](#)

Cannot Find Printer on Check Printer Settings Screen (Windows)

If the printer cannot be found and the **Check Printer Settings** screen appears after searching the printer by **Automatic search** on the **Search for Printers** screen, click **Redetect** and search for the printer again by the IP address on the **Search for Printers** screen.

If the printer has not been found after searching it by the IP address, check network settings.

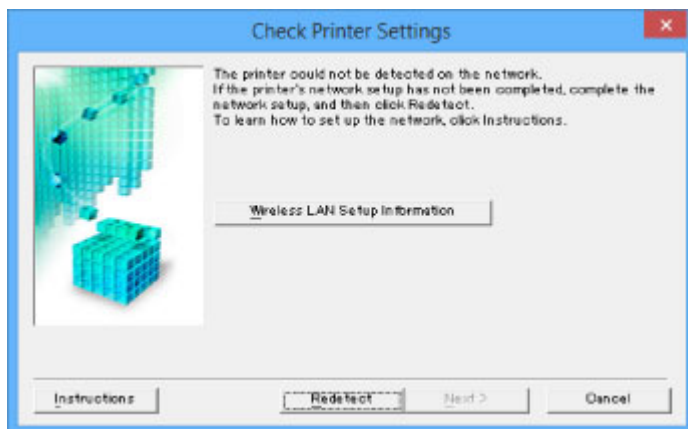

■ [Check 1: Cannot Find Printer on Check Printer Settings Screen During Wireless LAN Setup \(Windows\)](#)

■ [Check 1: Cannot Find Printer on Check Printer Settings Screen During Wired LAN Setup \(Windows\)](#)



Check 1: Cannot Find Printer on Check Printer Settings Screen During Wireless LAN Setup (Windows)



Check printer and network device (router, etc.) status.

Make sure printer is turned on.

■ [Confirming that the Power Is On](#)

Make sure network device (router, etc.) is turned on.

If printer or network device is off:

Turn on printer or network device.

It may take a while for the printer and network device to become ready for use once they are turned on.

Wait a while after turning on the printer or network device, and then click **Redetect** on the **Check Printer Settings** screen to redetect the printer.

If the printer is found, follow the instructions on the screen to continue to set up network communication.

If printer and network device are on:

If the network devices are on, turn them off and on again. If the printer cannot be found after that, go to Check 2.

■ [Check 2: Cannot Find Printer on Check Printer Settings Screen During Wireless LAN Setup \(Windows\)](#)



Check 2: Cannot Find Printer on Check Printer Settings Screen During Wireless LAN Setup (Windows)



Is printer set to allow wireless communication?

Make sure the  or  icon is displayed on the LCD.

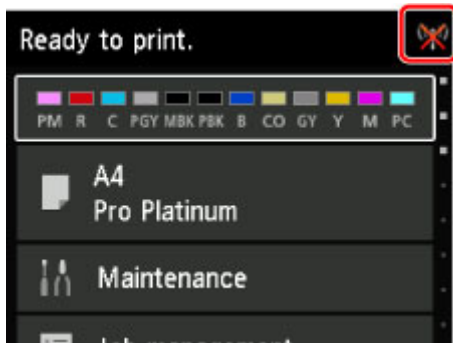

If icon is not displayed:

The printer is not set to allow wireless communication. Click **Wireless LAN Setup Information** on the **Check Printer Settings** screen to check the status and turn on wireless communication on the printer.

If icon is displayed:

Go to check 3.

[Check 3: Cannot Find Printer on Check Printer Settings Screen During Wireless LAN Setup \(Windows\)](#)



Check 3: Cannot Find Printer on Check Printer Settings Screen During Wireless LAN Setup (Windows)



Is printer connected to wireless router?

Use the icon on the LCD to make sure the printer is connected to the wireless router.

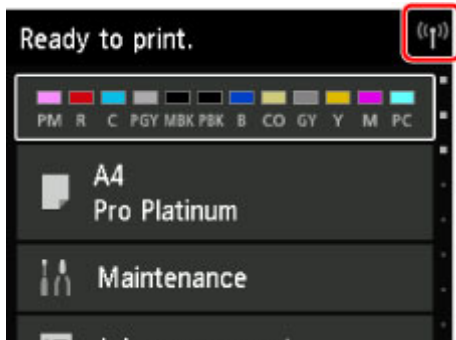

If icon is displayed:

- Checking wireless router settings

The printer and wireless router should be connected using 2.4 GHz bandwidth. Make sure the wireless router the printer is connected to is configured to use 2.4 GHz bandwidth.

Check the SSID of the wireless router for the printer on the LCD.

Select **Various settings** on the HOME screen and select **Device settings > LAN settings > Confirm LAN settings > WLAN setting list**.

For more on the wireless router, refer to the instruction manual supplied with the wireless router or contact its manufacturer.

- Checking wireless router location

After checking the wireless router setting, make sure the printer is not placed far away from the wireless router.

Place the wireless router and printer where there are no obstacles between them. Wireless communication between different rooms or floors is generally poor. Wireless communication can be impeded by building materials containing metal or concrete. If the printer cannot communicate with the computer over a wireless LAN due to a wall, place the printer and the computer in the same room.

In addition, if a device like a microwave oven that emits radio waves of the same frequency bandwidth as a wireless router is nearby, it may cause interference. Place the wireless router as far away from interference sources as possible.

After taking measures above, click **Redetect** on the **Check Printer Settings** screen to redetect the printer.

If the printer is found, follow the instructions on the screen to continue to set up network communication.

If the printer cannot be detected, the printer is not connected to the wireless router. Connect the printer to the wireless router.

After connecting the printer to the wireless router, set up the network communication from the beginning.

If  icon is displayed:

Go to check 4.

■ [Check 4: Cannot Find Printer on Check Printer Settings Screen During Wireless LAN Setup \(Windows\)](#)



Check 4: Cannot Find Printer on Check Printer Settings Screen During Wireless LAN Setup (Windows)



Is printer's IP address specified correctly?

If printer's IP address is not specified correctly, the printer may not be found. Make sure whether printer's IP address is not used for another device.

To check the printer's IP address, print out the network settings information or use the operation panel to display it.

- Display on the LCD.

■ [LAN settings \(Item for administrator\)](#)

- Print the network settings.

■ [Printing Network Settings](#)

If the IP address is not specified correctly:

See [If an error screen appears:](#) and specify the IP address.

If the IP address is specified correctly:

Go to check 5.

■ [Check 5: Cannot Find Printer on Check Printer Settings Screen During Wireless LAN Setup \(Windows\)](#)



Check 5: Cannot Find Printer on Check Printer Settings Screen During Wireless LAN Setup (Windows)



Does your security software's firewall or computer operating system interfere with network communications setup?

The firewall of your security software or operation system for computer may limit communication between the printer and your computer. Check the firewall setting of your security software or operation system or the message shown on your computer.

If firewall interferes with setup:

- **If message appears:**

If a message appears warning that Canon software is attempting to access the network, set the security software to allow access.

After allowing the software to access, click **Redetect** on the **Check Printer Settings** screen to redetect the printer.

If the printer is found, follow the instructions on the screen to continue to set up network communication.

- **If no message appears:**

Cancel the setup, and then set the security software to allow Canon software below to access the network.

Setup.exe or **Setup64.exe** in the **win > Driver > DrvSetup** folder on the Setup CD-ROM

After setting the security software, redo the network communication setup from the beginning.

▶▶▶ Note

- For more on firewall settings of your operating system or security software, see instruction manual or contact its manufacturer.

If firewall settings are not causing problem:

Go to check 6.

[■ Check 6: Cannot Find Printer on Check Printer Settings Screen During Wireless LAN Setup \(Windows\)](#)



Check 6: Cannot Find Printer on Check Printer Settings Screen During Wireless LAN Setup (Windows)



Check wireless router settings.

Check wireless router network connection settings, such as IP address filtering, MAC address filtering, and DHCP function.

Make sure the same radio channel is assigned to the wireless router and the printer.

To check the settings of the wireless router, see the instruction manual supplied with the wireless router or contact the manufacturer.

After checking the wireless router settings, click **Redetect** on the **Check Printer Settings** screen to redetect the printer.

If the printer is found, follow the instructions on the screen to continue to set up network communication.



Check 1: Cannot Find Printer on Check Printer Settings Screen During Wired LAN Setup (Windows)



Is LAN cable connected, and are printer and router on?

Make sure LAN cable is connected.

Make sure printer is turned on.

[Confirming that the Power Is On](#)

Make sure router is turned on.

If LAN cable is connected and printer or network device is off:

Turn on printer or network device.

It may take a while for the printer and network device to become ready for use once they are turned on.

Wait a while after turning on the printer or network device, and then click **Redetect** on the **Check Printer Settings** screen to redetect the printer.

If the printer is found, follow the instructions on the screen to continue to set up network communication.

If LAN cable is connected and printer and network device are on:

If the printer cannot not be found after trying to redetect it, even though the printer and the network device are on, go to Check 2.

[Check 2: Cannot Find Printer on Check Printer Settings Screen During Wired LAN Setup \(Windows\)](#)



Check 2: Cannot Find Printer on Check Printer Settings Screen During Wired LAN Setup (Windows)



Are computer and router configured and can computer connect to network?

Make sure you can view web pages on your computer.

If you cannot view any web pages:

Click **Cancel** on the **Check Printer Settings** screen to cancel to set up the network communication.

After that, configure the computer and network device.

For the procedures, refer to the instruction manuals supplied with the computer and network device, or contact their manufacturers.

If you can view web pages after configuring the computer and network device, try to set up the network communication from the beginning.

If you can view web pages:

Go to check 3.

■ [Check 3: Cannot Find Printer on Check Printer Settings Screen During Wired LAN Setup \(Windows\)](#)



Check 3: Cannot Find Printer on Check Printer Settings Screen During Wired LAN Setup (Windows)



Is printer set to allow wired communication?

Make sure the  icon is displayed on the LCD.

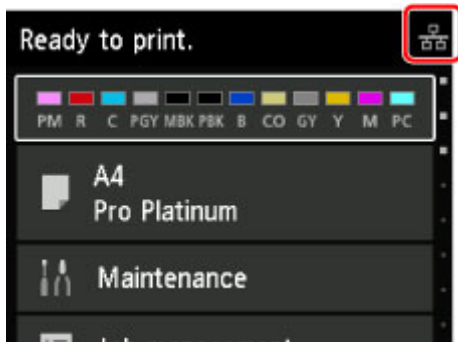

If icon is not displayed:

The printer is not set to allow wired communication. Turn on wired communication on the printer. Once you have turned on wired communication, redo the network communication setup from the beginning.

If icon is displayed:

Go to check 4.

[■ Check 4: Cannot Find Printer on Check Printer Settings Screen During Wired LAN Setup \(Windows\)](#)



Check 4: Cannot Find Printer on Check Printer Settings Screen During Wired LAN Setup (Windows)



Is printer connected to router?

Use the operation panel to make sure the printer is connected to the router.

Select **Various settings** on HOME screen and select **Device settings > LAN settings > Confirm LAN settings > LAN setting list**.

Make sure **Connection** on the LCD is set to **Active**.

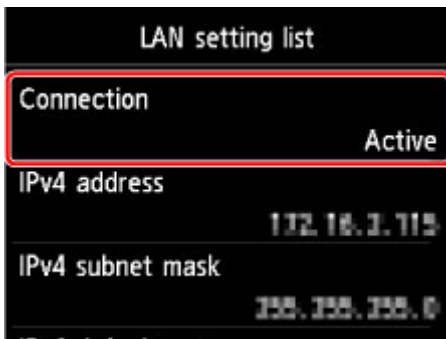

If Connection is set to Inactive:

The printer is not connected to the router. Connect the printer to the router.

Once you have connected the printer to the router, redo the network communication setup from the beginning.

If Connection is set to Active:

Go to check 5.

■ [Check 5: Cannot Find Printer on Check Printer Settings Screen During Wired LAN Setup \(Windows\)](#)



Check 5: Cannot Find Printer on Check Printer Settings Screen During Wired LAN Setup (Windows)



Is printer's IP address specified correctly?

If printer's IP address is not specified correctly, the printer may not be found. Make sure whether printer's IP address is not used for another device.

To check the printer's IP address, print out the network settings information or use the operation panel to display it.

- Display on the LCD.

■ [LAN settings \(Item for administrator\)](#)

- Print the network settings.

■ [Printing Network Settings](#)

If the IP address is not specified correctly:

See [If an error screen appears:](#) and specify the IP address.

If the IP address is specified correctly:

Go to check 6.

■ [Check 6: Cannot Find Printer on Check Printer Settings Screen During Wired LAN Setup \(Windows\)](#)



Check 6: Cannot Find Printer on Check Printer Settings Screen During Wired LAN Setup (Windows)



Does your security software's firewall or computer operating system interfere with network communications setup?

The firewall of your security software or operation system for computer may limit communication between the printer and your computer. Check the firewall setting of your security software or operation system or the message shown on your computer.

If firewall interferes with setup:

- **If message appears:**

If a message appears warning that Canon software is attempting to access the network, set the security software to allow access.

After allowing the software to access, click **Redetect** on the **Check Printer Settings** screen to redetect the printer.

If the printer is found, follow the instructions on the screen to continue to set up network communication.

- **If no message appears:**

Cancel the setup, and then set the security software to allow Canon software below to access the network.

Setup.exe or **Setup64.exe** in the **win > Driver > DrvSetup** folder on the Setup CD-ROM

After setting the security software, redo the network communication setup from the beginning.

▶▶▶ Note

- For more on firewall settings of your operating system or security software, see instruction manual or contact its manufacturer.

If firewall settings are not causing problem:

Go to check 7.

■ [Check 7: Cannot Find Printer on Check Printer Settings Screen During Wired LAN Setup \(Windows\)](#)



Check 7: Cannot Find Printer on Check Printer Settings Screen During Wired LAN Setup (Windows)



Check router settings.

Check router network connection settings such as IP address filtering, MAC address filtering, and DHCP function.

For more on checking the settings of the router, refer to the instruction manual supplied with the router or contact its manufacturer.

After checking the router settings, click **Redetect** on the **Check Printer Settings** screen to redetect the printer.

If the printer is found, follow the instructions on the screen to continue to set up network communication.



Cannot Find Printer on Select Printer Screen



The printer could not be detected with the current setup method.

Select **Set up the network connection according to the guide** radio button and click **Next**. The screen to show another setup method is displayed.

Canon series

1 2 3 4

Select Printer

Select from the list
The serial number can be found on the Letter of Guarantee and on the printer.

IPv4 Address IPv6 Address

Serial Number	IP Address	MAC Address
---------------	------------	-------------

Serial Number Location Update

Specify the IP address and run the search

Set up the network connection according to the guide.
Select this option if the printer is not displayed on the list or if it cannot be found by specifying the IP address.

Back to Top Next

Perform setup following the instructions on the screen.

►►► Note

- You can search for printers by an IP address or host name.

■ [Searching Printer by IP Address or Host Name During Setup](#)



Searching Printer by IP Address or Host Name During Setup



If the printer cannot be found on the **Select Printer** screen, search for the printer by an IP address or host name. Select **Specify the IP address and run the search** radio button and click **Next**. The screen to select searching criteria appears.

1. Check printer's IP address or host name.

To check the printer's IP address or host name, print out the network settings information or use the operation panel to display it.

- Display on the LCD.
 [LAN settings \(Item for administrator\)](#)
- Print the network settings.
 [Printing Network Settings](#)

▶▶▶ Note

- If you use the printer in an office, ask the network administrator.

2. Specify searching method.

Select one of the method below.

1. Search by IPv4 address

Select to search for printers by IPv4 address.

2. **Search by IPv6 address**

Select to search for printers by IPv6 address.

3. **Search by host name**

Select to search for printers by host name. A host name is referred to as LLMNR host name or Bonjour name.

3. Enter IP address or host name and click **Next**.

Printer search starts.

If an error screen appears:

Resolve the error according to the instruction on the screen.

If the IP address you entered is already used for another device, follow the procedure below to specify printer's IP address.

1. Select  **Various settings** on HOME screen.
[LCD and Operation Panel](#)
2. Use ▲▼ button to select **Device settings** and press **OK** button.
3. Use ▲▼ button to select **LAN settings** and press **OK** button.
4. Use ▲▼ button to select **Other settings** and press **OK** button.
5. Use ▲▼ button to select **TCP/IP settings** and press **OK** button.

If you specify IPv4 address:

1. Use ▲▼ button to select **IPv4** and press **OK** button.
2. Use ▲▼ button to select **Yes** on displayed screen and press **OK** button.
3. Use ▲▼ button to select **IP address** and press **OK** button.
4. Use ▲▼ button to select **Manual setup** and press **OK** button.
Selecting **Auto setup** and pressing **OK** buttons specifies the IP address automatically.
5. Enter IP address.
6. Use ▲▼◀▶ button to select **OK** and press **OK** button.
7. Enter subnet mask.
8. Use ▲▼◀▶ button to select **OK** and press **OK** button.
9. Enter default gateway.
10. Use ▲▼◀▶ button to select **OK** and press **OK** button.

The IPv4 address has been specified.

If you specify IPv6 address:

1. Use ▲▼ button to select **IPv6** and press **OK** button.

2. Select **Yes** on displayed screen and press **OK** button.
3. Use **▲▼** button to select **Manual address** and press **OK** button.
4. Use **▲▼** button to select **Use** and press **OK** button.
5. Use **▲▼** button to select **IP address** and press **OK** button.
6. Enter IP address.

Enter 8 number sequences divided by ":".

Ex. ABCD:EF01:2345:6789:ABCD:EF01:2345:6789

7. Use **▲▼◀▶** button to select **OK** and press **OK** button.
- The IPv6 address has been specified.

▶▶▶ Important

- If firewall is enabled on the computer, printers on a different subnet may not be detected. Disable firewall.

If firewall interferes with printer search:

- **If message appears:**

If a message appears warning that Canon software is attempting to access the network, set the security software to allow access.

After allowing the software to access, specify the IP address or host name and search for printers again.

If the printer is found, follow the instructions on the screen to continue to set up network communication.

- **If no message appears:**

Cancel searching printers, and then set the security software to allow Canon software below to access the network.

- For Windows:

Setup.exe or **Setup64.exe** in the **win > Driver > DrvSetup** folder on the Setup CD-ROM

- For Mac OS:

Setup.app, **canonijnetwork.bundle**, **cnwidsd.plugin**, and **cnwidss.plugin**

After setting the security software, specify the IP address or host name and search for printers again.

▶▶▶ Note

- For more on firewall settings of your operating system or security software, see instruction manual or contact its manufacturer.



Cannot Proceed beyond Printer Connection Screen



If you cannot proceed beyond the **Printer Connection** screen, check the following.

Check1 Make sure USB cable is securely plugged in to printer and computer.

Connect the printer and the computer using a USB cable as the illustration below. The USB port is located at the side of the printer.



Check2 Follow procedure below to connect printer and computer again.

▶▶▶ Important

- For Mac OS, make sure the lock icon is on the lower left of the **Printers & Scanners** screen (**Print & Scan** screen in Mac OS X v10.8 or Mac OS X v10.7).

If the  icon (locked) is displayed, click the icon to unlock. (The administrator name and the password are necessary to unlock.)

1. Turn off printer.
2. Unplug USB cable from printer and computer and connect it again.
3. Turn on printer.

Check3 If you cannot resolve problem, follow procedure below to reinstall printer driver.

1. Click **Cancel**.
2. Click **Start Over** on **Installation Failure** screen.
3. Click **Exit** on **Start Setup** screen and finish setup.
4. Turn off printer.
5. Restart computer.
6. Make sure you have no application software running.
7. Redo setup according to instructions on Canon website.

»» Note

- For Windows, you can use the Setup CD-ROM to redo setup.



Cannot Find Printer while Using Wireless LAN



Check1 Make sure printer is turned on.

Check2 Is  icon displayed on LCD?

If the icon is not displayed, select **Activate wireless LAN** on **Change LAN** in **LAN settings** on the HOME screen.

Check3 Make sure printer setup is complete.

If it is not, perform setup.

- For Windows:
Use the Setup CD-ROM or follow the instructions on the Canon website.
- For Mac OS:
Follow the instructions on the Canon website.

Check4 If using IJ Network Device Setup Utility, look for printer again. (Windows)

 IJ Network Device Setup Utility Screen

Check5 Make sure printer and wireless router network settings match.

Make sure the network settings of the printer (e.g. wireless router name, SSID, network key, etc.) are identical with those of the wireless router.

To check the settings of the wireless router, refer to the instruction manual provided with it or contact its manufacturer.

To check the current network settings of the printer, print out the network setting information.

 [Printing Network Settings](#)

If the printer network settings do not match with those of the wireless router, change the network settings of the printer to match with those of the wireless router.

Note

- For Windows, change printer's settings using IJ Network Device Setup Utility.
 Performing/Changing Wireless LAN Settings

Check6 Make sure the printer is not placed too far away from the wireless router.

Place the wireless router and printer where there are no obstacles between them. Wireless communication between different rooms or floors is generally poor. Wireless communication can be impeded by building materials containing metal or concrete. If the printer cannot communicate with the computer over a wireless LAN due to a wall, place the printer and the computer in the same room.

In addition, if a device like a microwave oven that emits radio waves of the same frequency bandwidth as a wireless router is nearby, it may cause interference. Place the wireless router as far away from interference sources as possible.

Check7 Make sure wireless signal is strong. Monitor signal status and move printer and wireless router as necessary.

▶▶▶ Note

- For Windows, monitor signal status using IJ Network Device Setup Utility.

■ Checking Wireless Network Status

Check8 Make sure computer network settings are correct.

For more on connecting and setting up a network device, see the device instruction manual or contact its manufacturer.

Check9 Make sure **Enable bidirectional support** is selected in **Ports** sheet of properties dialog box of printer driver. (Windows)

Check10 Make sure security software's firewall is off.

If your security software's firewall is on, a message may appear warning you that Canon software is attempting to access the network. If this warning message appears, set security software to always allow access.

If you are using any programs that switch between network environments, check their settings. Some programs use a firewall by default.

Check11 If printer is connected to an AirPort Base Station via LAN, use alphanumeric characters for network identifier (SSID). (Mac OS)

If the problem is not resolved, redo setup.

- For Windows:
Use the Setup CD-ROM or follow the instructions on the Canon website.
- For Mac OS:
Follow the instructions on the Canon website.



Cannot Find Printer while Using Wired LAN



Check1 Make sure printer is turned on.

Check2 Is  icon displayed on LCD?

If the icon is not displayed, select **Activate wired LAN** on **Change LAN** in **LAN settings** on the HOME screen.

Check3 Make sure LAN cable is connected properly.

Make sure the printer is connected to the router with the LAN cable. If the LAN cable is loose, connect the cable properly.

If the LAN cable is connected to the WAN side of the router, connect the cable to the LAN side of the router.

Network Connection Problems

- ▶ **Printer Suddenly Cannot Be Used**
- ▶ **Network Key Unknown**
- ▶ **Administrator Password Set for Printer Unknown**
- ▶ **Printer Cannot Be Used After Replacing Wireless Router or Changing Its Settings**
- ▶ **Printing Is Slow**
- ▶ **Cannot Access to Internet on Wireless LAN from Communication Device**
- ▶ **Ink Level Not Shown on Printer Status Monitor (Windows)**

Printer Suddenly Cannot Be Used

■ [Cannot Communicate with Printer Following Network Settings Change \(Windows\)](#)

■ [Cannot Communicate with Printer via Wireless LAN](#)

■ [Cannot Communicate with Printer Using Direct Connection](#)

■ [Cannot Communicate with Printer via Wired LAN](#)

■ [Cannot Print from Network Computer](#)



Cannot Communicate with Printer Following Network Settings Change (Windows)



It may take a while for the computer to obtain an IP address, or you may need to restart your computer. Make sure the computer has obtained a valid IP address, and try again to find the printer.



Cannot Communicate with Printer via Wireless LAN



Check1 Check printer and network device (router, etc.) status.

If the printer and network devices are off, turn them on.

If they are on, turn them off and on again.

Check2 Make sure printer and wireless router network settings match.

Make sure the network settings of the printer (e.g. wireless router name, SSID, network key, etc.) are identical with those of the wireless router.

To check the settings of the wireless router, refer to the instruction manual provided with it or contact its manufacturer.

To check the current network settings of the printer, print out the network setting information.

■ [Printing Network Settings](#)

If the printer network settings do not match with those of the wireless router, change the network settings of the printer to match with those of the wireless router.

▶▶▶ Note

- For Windows, change printer's settings using IJ Network Device Setup Utility.

■ [Performing/Changing Wireless LAN Settings](#)

Check3 Make sure the printer is not placed too far away from the wireless router.

Place the wireless router and printer where there are no obstacles between them. Wireless communication between different rooms or floors is generally poor. Wireless communication can be impeded by building

materials containing metal or concrete. If the printer cannot communicate with the computer over a wireless LAN due to a wall, place the printer and the computer in the same room.

In addition, if a device like a microwave oven that emits radio waves of the same frequency bandwidth as a wireless router is nearby, it may cause interference. Place the wireless router as far away from interference sources as possible.

Check4 Make sure wireless signal is strong. Monitor signal status and move printer and wireless router as necessary.

▶▶▶ Note

- For Windows, monitor signal status using IJ Network Device Setup Utility.
 - Checking Wireless Network Status

Check5 Make sure computer network settings are correct.

For more on connecting and setting up a network device, see the device instruction manual or contact its manufacturer.

Check6 Make sure you are using a valid channel.

Usable wireless channels may be limited depending on wireless network device used by your computer. See the instruction manual provided with your computer or wireless network device to check usable wireless channels.

Check7 Make sure channel set on wireless router is a usable channel as confirmed in Check 6.

If it is not, change the channel set on the wireless router.

Check8 Make sure security software's firewall is off.

If your security software's firewall is on, a message may appear warning you that Canon software is attempting to access the network. If this warning message appears, set security software to always allow access.

If you are using any programs that switch between network environments, check their settings. Some programs use a firewall by default.

Check9 If printer is connected to an AirPort Base Station via LAN, use alphanumeric characters for network identifier (SSID). (Mac OS)

If the problem is not resolved, redo setup.

- For Windows:
 - Use the Setup CD-ROM or follow the instructions on the Canon website.
- For Mac OS:
 - Follow the instructions on the Canon website.
- **Positioning:**
 - Make sure there are no obstacles between the wireless router and the printer.

Cannot Communicate with Printer Using Direct Connection

Check1 Make sure printer is turned on.

Check2 Is the  icon displayed on the LCD?

If the icon is not displayed, select **Activate direct connect.** on **Change LAN** in **LAN settings** on the HOME screen.

Check3 Make sure printer is selected as connection for wireless communication device (e.g. smartphone or tablet).

Select the identifier for direct connection (SSID) specified for the printer as the connection destination for communication devices.

Check4 Have you entered the proper password specified for the direct connection?

If the security setting of the direct connection is enabled, you need to enter the password to connect your communication device to the printer.

To check the password specified for the printer, display it using the operation panel of the printer or print out the network setting information of the printer.

- Display on the LCD.
 - [LAN settings \(Item for administrator\)](#)
- Print the network settings.
 - [Printing Network Settings](#)

Check5 Make sure the printer is not placed too far away from the wireless router.

Place the wireless router and printer where there are no obstacles between them. Wireless communication between different rooms or floors is generally poor. Wireless communication can be impeded by building materials containing metal or concrete. If the printer cannot communicate with the computer over a wireless LAN due to a wall, place the printer and the computer in the same room.

In addition, if a device like a microwave oven that emits radio waves of the same frequency bandwidth as a wireless router is nearby, it may cause interference. Place the wireless router as far away from interference sources as possible.

Check6 Make sure 5 devices are already connected.

Direct Connection does not allow more than 5 devices to be connected.

Cannot Communicate with Printer via Wired LAN

Check1 Make sure printer is turned on.

Check2 Make sure the LAN cable is connected properly.

Make sure the printer is connected to the router with the LAN cable. If the LAN cable is loose, connect the cable properly.

If the LAN cable is connected to the WAN side of the router, connect the cable to the LAN side of the router.

If the problem is not resolved, redo setup.

- For Windows:
Use the Setup CD-ROM or follow the instructions on the Canon website.
- For Mac OS:
Follow the instructions on the Canon website.

Cannot Print from Network Computer

Check1 Make sure computer network settings are correct.

For more on computer setup, see your computer instruction manual or contact its manufacturer.

Check2 If printer driver is not installed, install it.

- For Windows:
Install the printer driver using the Setup CD-ROM or install it from the Canon website.
- For Mac OS:
Install the printer driver from the Canon website.

Check3 When using wireless LAN, make sure wireless router does not restrict which computers can access it.

For more on connecting to and setting up your wireless router, see the wireless router instruction manual or contact its manufacturer.

Note

- To check the MAC address or IP address of your computer, see [Checking Computer IP Address or MAC Address](#).

Network Key Unknown

■ [WPA/WPA2 or WEP Key Set for Access Point Unknown, Cannot Connect](#)

■ [Setting an Encryption Key](#)

WPA/WPA2 or WEP Key Set for Access Point Unknown, Cannot Connect

For details on setting up a wireless router, see the instruction manual provided with the wireless router or contact its manufacturer. Make sure your computer can communicate with the wireless router.

Set up the printer to match the wireless router settings.

Setting an Encryption Key

For details on setting up a wireless router, see the instruction manual provided with the wireless router or contact its manufacturer. Make sure your computer can communicate with the wireless router.

Set up the printer to match the wireless router settings.

- **Using WPA/WPA2**

The authentication method, passphrase, and dynamic encryption type must be the same for the wireless router, the printer, and your computer.

Enter the passphrase configured on the wireless router (a sequence of between 8 and 63 alphanumeric characters, or a 64-character hexadecimal number).

Either TKIP (basic encryption) or AES (secure encryption) is selected automatically as the dynamic encryption method.

For Windows, see [If WPA/WPA2 Details Screen Appears](#).

If the printer is connected to an AirPort Base Station via a LAN using Mac OS, check the settings in **Wireless Security** of **AirPort Utility**.

Note

- This printer supports WPA/WPA2-PSK (WPA/WPA2-Personal) and WPA2-PSK (WPA2-Personal).

- **Using WEP**

The key length, key format, key to use (one of 1 to 4), and authentication method must be the same for the wireless router, the printer, and your computer.

To communicate with a wireless router that uses automatically generated WEP keys, you must set the printer to use the key generated by the wireless router, entering it in hexadecimal format.

- For Windows, when the **WEP Details** screen appears after you click **Search...** on the **Protocol Settings (Wireless LAN)** screen, follow the on-screen instructions and set the key length, the key format, and the key number to enter a WEP key.

For details, see If WEP Details Screen Appears.

- If the printer is connected to an AirPort Base Station via a LAN using Mac OS, check the settings in **Wireless Security** of **AirPort Utility**.



Administrator Password Set for Printer Unknown



Initialize the printer settings.

Select **Reset all** to restore administrator password to default.

■ [Reset setting \(Item for administrator\)](#)

After initializing the printer settings, redo setup.

- **For Windows:**

Use the Setup CD-ROM or follow the instructions on the Canon website.

- **For Mac OS:**

Follow the instructions on the Canon website.



Printer Cannot Be Used After Replacing Wireless Router or Changing Its Settings



When you replace a wireless router, redo the network setup for the printer.

- For Windows:
Use the Setup CD-ROM or follow the instructions on the Canon website.
- For Mac OS:
Follow the instructions on the Canon website.

If this does not solve the problem, see below.

■ [Cannot Communicate with Printer After Enabling MAC/IP Address Filtering or Encryption Key on Wireless Router](#)

■ [With Encryption On, Cannot Communicate with Printer After Changing Encryption Type at Wireless Router](#)



Cannot Communicate with Printer After Enabling MAC/IP Address Filtering or Encryption Key on Wireless Router



Check1 Check wireless router setting.

To check the wireless router setting, see the instruction manual provided with the wireless router or contact its manufacturer. Make sure the computer and the wireless router can communicate with each other under this setting.

Check2 If filtering MAC addresses or IP addresses at wireless router, check that MAC addresses or IP addresses for computer, network device, and printer are registered.

Check3 If using WPA/WPA2 or WEP key, make sure encryption key for computer, network device, and printer matches key set for wireless router.

Not only the WEP key itself, but also the key length, key format, the key ID to use, and the authentication method must be the same for the printer, the wireless router, and the computer.

For details, see [Setting an Encryption Key](#).

Q With Encryption On, Cannot Communicate with Printer After Changing Encryption Type at Wireless Router

A

If you change the encryption type for the printer and it subsequently cannot communicate with the computer, make sure the encryption type for the computer and the wireless router matches the type set for the printer.

■ [Cannot Communicate with Printer After Enabling MAC/IP Address Filtering or Encryption Key on Wireless Router](#)



Printing Is Slow



Check1 Printer may be printing a large job from another computer.

Check2 When using wireless LAN, make sure the printer is not placed too far away from the wireless router.

Place the wireless router and printer where there are no obstacles between them. Wireless communication between different rooms or floors is generally poor. Wireless communication can be impeded by building materials containing metal or concrete. If the printer cannot communicate with the computer over a wireless LAN due to a wall, place the printer and the computer in the same room.

In addition, if a device like a microwave oven that emits radio waves of the same frequency bandwidth as a wireless router is nearby, it may cause interference. Place the wireless router as far away from interference sources as possible.

Check3 When using wireless LAN, make sure wireless signal is strong. Monitor signal status and move printer and wireless router as necessary.

▶▶▶ Note

- For Windows, monitor signal status using IJ Network Device Setup Utility.

■ Checking Wireless Network Status



Cannot Access to Internet on Wireless LAN from Communication Device



Check1 Is your device connected to printer using direct connection?

If your device is connected to the printer using direct connection, you cannot access to the Internet. Turn off direct connection and connect your device to the wireless router.

For details, see the instruction manual provided with your device and wireless router.

Check2 Is wireless router on?

Check3 Is wireless router configured properly?

For more on checking wireless router settings, see the instruction manual provided with the wireless router or contact its manufacturer.

Check4 Check your device and wireless router location.

Check the distance between your device and wireless router, and check for obstruction or source of radio wave interference nearby.



Ink Level Not Shown on Printer Status Monitor (Windows)



Use the printer driver with bidirectional communication.

Select **Enable bidirectional support** in the **Ports** sheet of the properties dialog box of the printer driver.

■ How to Open the Printer Driver Setup Window

Other Network Problems

- [Message Appears on Computer During Setup](#)
- [Checking Network Information](#)
- [Restoring to Factory Defaults](#)

Message Appears on Computer During Setup

■ [Confirm Printer Password Screen Appears During Setup \(Windows\)](#)

■ [Encryption Settings Screen Appears When Access Point Selected from Search Screen](#)

■ ["You are connecting the printer to the non encrypted wireless network" Appears](#)

Q Confirm Printer Password Screen Appears During Setup (Windows)

A

The following screen appears if the printer is set up for use with a network and an administrator password has been set.

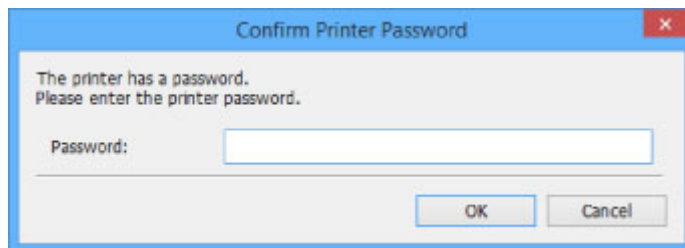

Enter the administrator password set for the printer.

»» Note

- An administrator password is already set for the printer at the time of purchase.
For details:
 - [Administrator Password](#)
- For improved security, we recommend that you change the administrator password.
Change the administrator password using IJ Network Device Setup Utility.
 - [Changing Administrator Password](#)

Q Encryption Settings Screen Appears When Access Point Selected from Search Screen

A

This screen appears automatically if the selected wireless router is encrypted. Set the same encryption settings as those set for the wireless router.

»» Note

- For Windows, specify the encryption settings using IJ Network Device Setup Utility.
 - [Performing/Changing Wireless LAN Settings](#)

Q "You are connecting the printer to the non encrypted wireless network" Appears

A

Security is not configured on the wireless router. The printer can still be used, so continue the setup procedure and complete it.

»» Important

- If you connect to a network that is not protected with security measures, there is a risk of disclosing data such as your personal information to a third party.

Checking Network Information

■ [Checking Printer IP Address or MAC Address](#)

■ [Checking Computer IP Address or MAC Address](#)

■ [Checking Communication Between the Computer, the Printer, and the Wireless Router](#)

■ [Checking Network Settings Information](#)



Checking Printer IP Address or MAC Address



To check the printer's IP Address or MAC address, print out the network settings information or use the operation panel to display it.

- Display on the LCD.

■ [LAN settings \(Item for administrator\)](#)

- Print the network settings.

■ [Printing Network Settings](#)

▶▶▶ Note

- For Windows, check the network setting information using IJ Network Device Setup Utility.
 - [IJ Network Device Setup Utility Screen](#)



Checking Computer IP Address or MAC Address



To check the IP Address or MAC address of your computer, follow the instructions below.

- For Windows:

1. Select **Command Prompt** as shown below.

- In Windows 8.1 or Windows 8, select **Command Prompt** from the **Start** screen. If **Command Prompt** is not displayed on the **Start** screen, select the **Search** charm and search for "**Command Prompt**".
- In Windows 7 or Windows Vista, click **Start > All Programs > Accessories > Command Prompt**.

2. Enter "ipconfig/all" and press **Enter**.

The IP address and MAC address of your computer appear. If your computer is not connected to a network, the IP address does not appear.

- For Mac OS:

1. Select **System Preferences** from Apple menu, and then click **Network**.

2. Make sure network interface used by computer is selected, and then click **Advanced**.

When you are using wireless LAN on your computer, make sure **Wi-Fi** is selected as network interface. When you are using wired LAN, make sure **Ethernet** is selected.

3. Check the IP address or MAC address.

Click **TCP/IP** to check the IP address.

Click **Hardware** to check the MAC address.

Checking Communication Between the Computer, the Printer, and the Wireless Router

A

Perform a ping test to check if communication is taking place.

- For Windows:

1. Select **Command Prompt** as shown below.

- In Windows 8.1 or Windows 8, select **Command Prompt** from the **Start** screen. If **Command Prompt** is not displayed on the **Start** screen, select the **Search** charm and search for "**Command Prompt**".
- In Windows 7 or Windows Vista, click **Start > All Programs > Accessories > Command Prompt**.

2. Type ping command and press **Enter**.

The ping command is as follows: ping XXX.XXX.XXX.XXX

"XXX.XXX.XXX.XXX" is the IP address of the target device.

If communication is taking place, a message like the one shown below appears.

Reply from XXX.XXX.XXX.XXX: bytes=32 time=10ms TTL=255

If **Request timed out** appears, communication is not taking place.

- For Mac OS:

1. Start **Network Utility** as shown below.

- In Mac OS X v10.10 or Mac OS X v10.9, select **Computer** from **Go** menu of Finder, double-click **Macintosh HD > System > Library > CoreServices > Applications > Network Utility**.
- In Mac OS X v10.8 or Mac OS X v10.7, open **Utilities** folder in **Applications** folder and double-click **Network Utility**.

2. Click **Ping**.

3. Make sure **Send only XX pings** (XX are numbers) is selected.

4. Enter IP address of target printer or target wireless router in **Enter the network address to ping**.

5. Click **Ping**.

"XXX.XXX.XXX.XXX" is the IP address of the target device.

A message such as the following appears.

64 bytes from XXX.XXX.XXX.XXX: icmp_seq=0 ttl=64 time=3.394 ms

64 bytes from XXX.XXX.XXX.XXX: icmp_seq=1 ttl=64 time=1.786 ms

64 bytes from XXX.XXX.XXX.XXX: icmp_seq=2 ttl=64 time=1.739 ms

--- XXX.XXX.XXX.XXX ping statistics ---

3 packets transmitted, 3 packets received, 0% packet loss

If packet loss is 100%, communication is not taking place. Otherwise, computer is communicating with target device.

Checking Network Settings Information

To check the printer's network settings information, print out the network settings information or use the operation panel to display it.

- Display on the LCD.
 - [LAN settings \(Item for administrator\)](#)
- Print the network settings.
 - [Printing Network Settings](#)



Restoring to Factory Defaults



▶▶▶ Important

- For Windows:

Initialization erases all network settings on the printer, making printing operation from a computer over a network impossible. To use the printer over a network again after restoring it to the factory defaults, use the Setup CD-ROM or follow the instructions on the Canon website to redo setup.

- For Mac OS:

Initialization erases all network settings on the printer, making printing operation from a computer over a network impossible. To use the printer over a network again after restoring it to the factory defaults, follow the instructions on the Canon website to redo setup.

Initialize the network setting using the printer's operation panel.

■ [Reset setting \(Item for administrator\)](#)

Problems while Printing from Smartphone/Tablet

- ▶ [Cannot Print from Smartphone/Tablet](#)

Cannot Print from Smartphone/Tablet

If you cannot print from your smartphone/tablet, it is possible that your smartphone/tablet cannot communicate with the printer.

Check the cause of your problem according to the connection method.

■ [Cannot Communicate with Printer over Wireless LAN](#)

■ [Cannot Communicate with Printer while It Is in Direct Connection](#)

▶▶▶ Note

- For problems on printing with other connection methods or more on performing settings of each connection method:

■ [Using PIXMA/MAXIFY Cloud Link](#)

■ [Printing with Google Cloud Print](#)

■ [Printing from an AirPrint-enabled Printer with iOS Device](#)



Cannot Communicate with Printer over Wireless LAN



If your smartphone/tablet cannot communicate with the printer, check the following.

Check1 Make sure printer is turned on.

Check2 Is  icon displayed on LCD?

Press the **HOME** button, select **LAN settings**, and then set **Change LAN** to **Activate wireless LAN**.

If the  icon is displayed, the printer is not connected to the wireless router.

Check3 Are network settings of printer identical with those of wireless router?

Make sure the network settings of the printer (e.g. wireless router name, SSID, network key, etc.) are identical with those of the wireless router.

To check the settings of the wireless router, refer to the instruction manual provided with it or contact its manufacturer.

To check the current network settings of the printer, print out the network setting information.

■ [Printing Network Settings](#)

For Windows, if the network settings of the printer are not identical with those of the wireless router, change the network settings of the printer to match with those of the wireless router using IJ Network Device Setup Utility.

Check4 Are network settings of your smartphone/tablet identical with those of wireless router?

Make sure the network settings of your smartphone/tablet (e.g. wireless router name, SSID, network key, etc.) are identical with those of the wireless router.

To check the settings of your smartphone/tablet, refer to the instruction manual provided with it.

If the network settings of your smartphone/tablet are not identical with those of the wireless router, change the network settings of it to match with those of the wireless router.

Check5 Make sure printer is not too far away from wireless router.

The wireless router is located indoors within the effective range for wireless communication. Locate the printer within 164 ft. / 50 m from the wireless router.

Check6 Check for obstructions.

Wireless communication between different rooms or floors is generally poor. Move the printer and wireless router as necessary.

Check7 Make sure there is no source of radio wave interference nearby.

If a device like a microwave oven that emits radio waves of the same frequency bandwidth as a wireless router is nearby, it may cause interference. Place the wireless router as far away from the interference source as possible.

Cannot Communicate with Printer while It Is in Direct Connection

A

If your smartphone/tablet cannot communicate with the printer in the direct connection, check the following.

Check1 Make sure printer is turned on.

Check2 Is  icon displayed on LCD?

Press the **HOME** button, select **LAN settings** and then set **Change LAN** to **Activate direct connect**.

Check3 Check settings of your smartphone/tablet.

Make sure your smartphone/tablet can use the wireless LAN.

For more on performing setting of the wireless LAN, refer to the instruction manual provided with your smartphone/tablet.

Check4 Have you selected printer as destination of your smartphone/tablet?

Select the access point name (SSID) of the printer with your smartphone/tablet.

Check5 Have you entered proper password specified for direct connection?

If the security setting of the direct connection is enabled, you need to enter the password to connect your smartphone/tablet to the printer.

Check6 Make sure printer is not too far away.

Locate your smartphone/tablet close enough to communicate with the printer.

Check7 Check for obstructions.

Wireless communication between different rooms or floors is generally poor. Move the printer as necessary.

Check8 Make sure there is no source of radio wave interference nearby.

If a device like a microwave oven that emits radio waves of the same frequency bandwidth as a wireless router is nearby, it may cause interference. Place the printer as far away from the interference source as possible.

Check9 Make sure 5 devices are already connected.

Direct connection does not allow more than 5 devices to be connected.

Printing Problems

- ▶ **Printing Does Not Start**
- ▶ **Paper Jams**
- ▶ **Print Results Are Unsatisfactory**
- ▶ **No Ink Comes Out**
- ▶ **Paper Does Not Feed Properly/"No Paper" Error**
- ▶ **Printing Stops**
- ▶ **Cannot Print Using AirPrint**
- ▶ **Paper Does Not Feed from Paper Source Specified in Printer Driver (Windows)**



Printing Does Not Start



Check1 Make sure printer is securely plugged in and press **ON** button to turn it on.

The **POWER** lamp flashes while the printer is initializing. Wait until the **POWER** lamp stops flashing and remains lit.

▶▶▶ Note

- If you are printing large data such as photos or other graphics, printing may take longer to start. The **POWER** lamp flashes while the computer is processing data and sending it to the printer. Wait until printing starts.

Check2 If printer is turned off for some time, it may take longer to start printing.

Wait until printing starts.

Check3 Make sure printer is properly connected to computer.

If you are using a USB cable, make sure it is securely connected to both the printer and the computer. When the USB cable is securely plugged in, check the following:

- If you are using a relay device such as a USB hub, disconnect it, connect the printer directly to the computer, and retry the printing. If printing starts normally, there is a problem with the relay device. Contact the vendor of the relay device.
- There could also be a problem with the USB cable. Replace the USB cable and retry the printing.

If you use the printer over a LAN, make sure the printer is connected to the network with a LAN cable or is correctly set up for network use.

Check4 Is direct connection enabled?

To print using a mode other than the direct connection, disable the direct connection first.

■ [Using Printer with Direct Connection](#)

Check5 Make sure paper settings match information set for rear tray.

If the paper settings do not match the information set for the rear tray, an error message appears on the LCD. Follow the instructions on the LCD to solve the problem.

■ [Paper Settings](#)

▶▶▶ Note

- You can select whether the message which prevents misprinting is displayed.
 - To change the message view setting when printing using the printer's operation panel:
 - [Paper-related settings](#)
 - To change the message view setting when printing using the printer driver:
 - [Changing the Printer Operation Mode \(Windows\)](#)

Check6 If printing from a computer, delete unnecessary print jobs.

- For Windows:

■ [Deleting the Undesired Print Job](#)

- For Mac OS:

■ [Deleting the Undesired Print Job](#)

Check7 Is feed slot cover closed?

If the feed slot cover is opened, close it slowly and press the **OK** button.

Check8 Is manual feed tray in paper feed position?

If the manual feed tray is in the paper jam clearing position, return the tray to the paper feed position and press the **OK** button on the printer.

Check9 Is tank cover closed?

If the tank cover is opened when printing, close it.

Check10 Does page size setting match size of paper loaded in printer?

- For Windows:

Press the **OK** button on the printer to clear the error. Then check **Page Size** setting in **Page Setup** sheet of the printer driver and load paper that is the same size as the setting and try printing again.

Set the printer not to detect the width of the paper using the printer driver.

To set the printer not to detect the width of the paper, open the printer driver setup window, and in **Custom Settings** under **Maintenance** sheet, select **Disable paper width detection when printing from computer** check box, and then click **OK**.

To open the printer driver setup window, see [How to Open the Printer Driver Setup Window](#).

* Clear **Disable paper width detection when printing from computer** check box again once printing is complete, and then click **OK**.

- For Mac OS:

Press the **OK** button on the printer to clear the error. Then check the **Paper Size** setting in the Page Setup dialog and load paper that is the same size as the setting and try printing again.

Set the printer not to detect the width of the paper using the Canon IJ Printer Utility.

To set the printer not to detect the width of the paper, open the Canon IJ Printer Utility, select **Custom Settings** in the pop-up menu, select **Disable paper width detection when printing from computer** check box, and then click **Apply**.

To open the Canon IJ Printer Utility, see [Opening the Canon IJ Printer Utility](#).

* Clear the **Disable paper width detection when printing from computer** check box again once printing is complete, and then click **Apply**.

Check11 Are media type and paper size specified properly in the printer driver?

When the media type is specified to **Photo Paper Pro Premium Matte** or **Matte Photo Paper** in the printer driver, specify a paper size from the following size that has wide margins.

- **A4 (Margin 25)**
- **Letter (Margin 25)/US Letter (Margin 25)**
- **A3 (Margin 25)**
- **A3+ (Margin 25)**
- **A2 (Margin 25)**
- **17"x22" (Margin 25)/C (Margin 25)**

▶▶▶ Important

- By canceling the safety margin regulation with the following method, you can print with normal paper size.
 - For Windows:

Click **Print Options** on **Page Setup** sheet of the printer driver. Then select **Cancel the safety margin regulation for paper size** check box in the dialog that appears.
 - For Mac OS:

Select **Cancel Margin Regulation** check box in **Paper Detailed Settings** in the Print dialog.

If you print with normal paper size, conditions such as paper abrasion may cause paper stains or deterioration of print quality depending on the environment. We recommend that you print with a paper size that has wide margins.

Check12 Is your printer's printer driver is selected when printing?

The printer will not print properly if you are using a printer driver for a different printer.

- For Windows:

Make sure "Canon XXX series" (where "XXX" is your printer's name) is selected in the Print dialog box.

▶▶▶ Note

- To make the printer the one selected by default, select **Set as Default Printer**.

- For Mac OS:

Make sure your printer's name is selected in **Printer** in the Print dialog.

▶▶▶ Note

- To make the printer the one selected by default, select the printer for **Default printer**.

Check13 Set correct printer port. (Windows)

Make sure the correct printer port is set.

1. Log in using an account with administrator privileges.
2. Make the following settings.
 - In Windows 8.1 or Windows 8, select **Control Panel** from **Settings** charm on **Desktop > Hardware and Sound > Devices and Printers**.
 - In Windows 7, select **Devices and Printers** from **Start** menu.
 - In Windows Vista, select **Start** menu > **Control Panel > Hardware and Sound > Printers**.
3. Open printer driver properties.
 - In Windows 8.1, Windows 8, or Windows 7, right-click "Canon XXX series" icon (where "XXX" is your printer's name), and then select **Printer properties**.

- In Windows Vista, right-click "Canon XXX series" icon (where "XXX" is your printer's name), and then select **Properties**.

4. Click **Ports** tab to check port settings.

Make sure a port named "USBnnn" (where "n" is a number) with "Canon XXX series" appearing in **Printer** column is selected for **Print to the following port(s)**.

- If setting is incorrect:

Reinstall the printer driver from the Setup CD-ROM or the Canon website.

- Printing does not start even though the printer is connected to the computer using a USB cable and the port named "USBnnn" is selected:

In Windows 8.1 or Windows 8, select **My Printer** on **Start** screen to start **My Printer**. If **My Printer** is not displayed on **Start** screen, select **Search** charm, and then search for "**My Printer**".

Set the correct printer port on **Diagnose and Repair Printer**. Follow the on-screen instructions to set the correct printer port, and then select your printer's name.

In Windows 7 or Windows Vista, click **Start** and select **All programs, Canon Utilities, Canon My Printer, Canon My Printer**, and then select **Diagnose and Repair Printer**. Follow the on-screen instructions to set the correct printer port, and then select your printer's name.

If the problem is not resolved, reinstall the printer driver from the Setup CD-ROM or the Canon website.

Check14 Is print data extremely large? (Windows)

Click **Print Options** on **Page Setup** sheet of the printer driver. Then make sure **Prevention of Print Data Loss** is set to **On (Weak)** in the dialog that appears.

If printing does not start even though **Prevention of Print Data Loss** is set to **On (Weak)**, set it to **On (Strong)** and start printing again.

* This may reduce print quality.

Check15 If printing from your computer, restart computer.



Paper Jams



When paper jams, a troubleshooting message appears automatically. Take the appropriate action described in the message.

- **When a Support Code and a Message Are Displayed on Computer Screen:**

- For Windows:

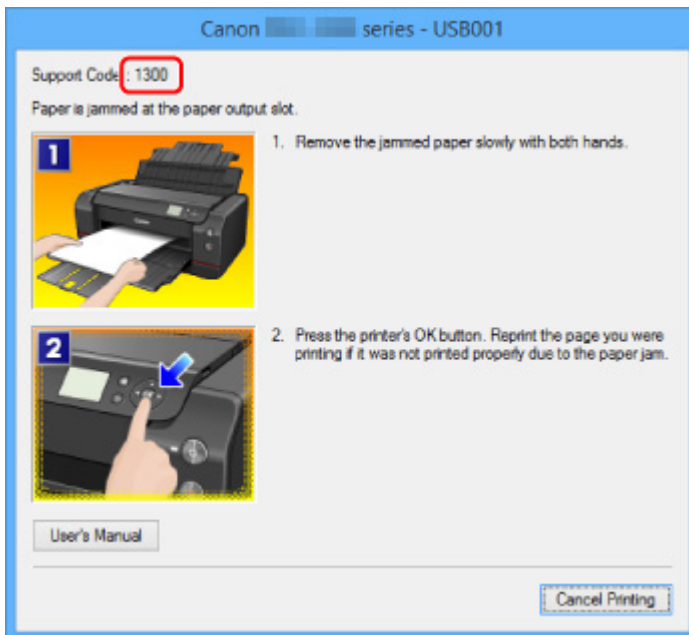

- For Mac OS:

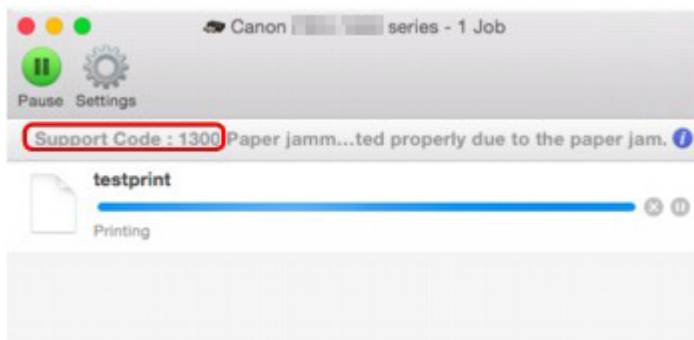

* The screen differs depending on the OS you are using.

- When a Support Code and a Message Are Displayed on LCD:

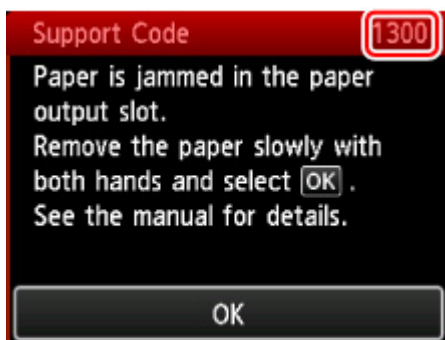

To remove the jammed paper, see [List of Support Code for Error \(Paper Jams\)](#).

▶▶▶ Note

- You can also search for details on resolving the errors indicated by the support code shown.

■ [Search](#)



Print Results Are Unsatisfactory



If the print results are unsatisfactory due to white streaks, misaligned lines, or uneven colors, check the paper and print quality settings first.

Check1 Do page size and media type settings match size and type of loaded paper?

If these settings do not match, it is not possible to obtain the proper result.

If you are printing a photograph or an illustration, an incorrect paper type setting may reduce the quality of the printout color.

Also, if you print with an incorrect paper type setting, the printed surface may be scratched.

In borderless printing, uneven coloring may occur depending on the combination of the paper type setting and the loaded paper.

The method for checking the paper and print quality settings differs depending on what you are using your printer for.

Printing from a PictBridge (Wireless LAN) compliant device	<p>Check the settings on your PictBridge (Wireless LAN) compliant device.</p> <ul style="list-style-type: none"> ■ PictBridge (Wireless LAN) Print Settings <p>Check the settings using the operation panel.</p> <ul style="list-style-type: none"> ■ PictBridge print settings
Printing from your computer	<p>Check the settings using the printer driver.</p> <ul style="list-style-type: none"> ■ Printing with Easy Setup

Check2 Make sure appropriate print quality is selected (see table above).

Select a print quality suited to the paper and to what you are printing. If you notice blurs or uneven colors, increase the print quality setting and retry the printing.

▶▶▶ Note

- When printing from a PictBridge (Wireless LAN) compliant device, set the print quality setting using the operation panel.

This setting cannot be made on the PictBridge (Wireless LAN) compliant device.

Check3 When using wireless LAN, make sure radio status is good.

■ Checking Wireless Network Status

If the radio status is poor, it may be possible that print results are not satisfactory or the printing speed is slow. Retry printing after the radio status improves.

If the problem is not resolved even after the radio status improves, use the printer via USB or a wired LAN.

Check4 If problem is not resolved, check other causes.

See also the sections below:

- ■ [Cannot Complete Printing](#)
- ■ [Paper Is Blank/Printing Is Blurry/Colors Are Wrong/White Streaks Appear](#)
- ■ [Lines Are Misaligned](#)
- ■ [Lines Incomplete or Missing \(Windows\)](#)
- ■ [Images Incomplete or Missing \(Windows\)](#)
- ■ [Ink Blots / Paper Curl](#)
- ■ [Paper Is Smudged / Printed Surface Is Scratched](#)
- ■ [Back of Paper Is Smudged](#)
- ■ [Vertical Line Next to Image](#)
- ■ [Uneven or Streaked Colors](#)
- ■ [Small Dots of Ink Adheres to Margins of Paper](#)
- ■ [Printed Colors Are Inaccurate](#)
- ■ [Documents Are Printed in Monochrome](#)



Cannot Complete Printing



Check1 Select setting not to compress printing data. (Windows)

If you select the setting not to compress the printing data with an application software you are using, the printing result may be improved.

Click **Print Options** on **Page Setup** sheet of the printer driver. Select **Do not allow application software to compress print data** check box and click **OK**.

* Clear the check box once printing is complete.

Check2 Is print data extremely large? (Windows)

Click **Print Options** on **Page Setup** sheet of the printer driver. Then make sure **Prevention of Print Data Loss** is set to **On (Weak)** in the dialog that appears.

If printing does not start even though **Prevention of Print Data Loss** is set to **On (Weak)**, set it to **On (Strong)** and start printing again.

* This may reduce print quality.

Check3 Your hard disk may not have sufficient free space to store job.

Delete unnecessary files to free up disk space.



Paper Is Blank/Printing Is Blurry/Colors Are Wrong/White Streaks Appear

❖ Paper Is Blank



❖ Printing Is Blurry

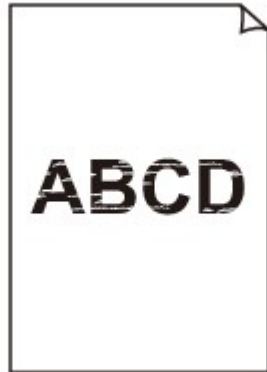

❖ Colors Are Wrong



White Streaks Appear

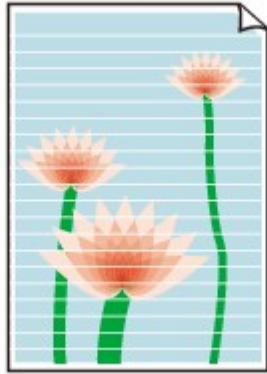

A

Check1 Check paper and print quality settings.

 [Print Results Are Unsatisfactory](#)

Check2 Check status of ink tanks. Replace ink tank if ink has run out.

 [Replacing Ink](#)

Check3 Print nozzle check pattern and perform any necessary maintenance operations such as print head cleaning.

Print the nozzle check pattern to determine whether the ink ejects properly from the print head nozzles.

For details on printing the nozzle check pattern, print head cleaning, print head deep cleaning, and system cleaning, see [Maintenance Procedure](#).

- If nozzle check pattern is not printed correctly:
Check if the ink tank for the problem color is empty.
If the ink tank is not empty, perform print head cleaning and try printing the nozzle check pattern again.
- If problem is not resolved after performing print head cleaning twice:
Perform print head deep cleaning.
- If problem is not resolved after performing print head deep cleaning:
Perform system cleaning manually.

If the problem is not resolved after performing the system cleaning manually, perform the print head deep cleaning after 24 hours later. If the problem is not resolved yet, the print head may be damaged. Contact your nearest Canon service center to request a repair.

Note

- If you use the printer in the highlands, the blurs and the streaks may appear on the print result at regular intervals (about 2 to 3 months) by barometric effects. To prevent blur and streak, set **System cleaning frequency** to **Short** on the printer's operation panel.
System cleaning consumes many ink. Set **System cleaning frequency** to **Short** if necessary.

Check4 When using paper with one printable surface, make sure paper is loaded with printable side facing up.

Printing on the wrong side of such paper may cause unclear prints or prints with reduced quality.
Refer to the instruction manual supplied with the paper for detailed information on the printable side.



Lines Are Misaligned



Check1 Check paper and print quality settings.

 [Print Results Are Unsatisfactory](#)

Check2 Perform print head alignment.

If printed lines are misaligned or print results are otherwise unsatisfactory, adjust the print head position.

 [Aligning the Print Head](#)

Note

- If the problem is not resolved after performing the print head alignment, perform print head alignment manually. See [Aligning the Print Head Manually](#).

Check3 Increase print quality and try printing again.

Increasing the print quality using the printer driver may improve the print result.



Lines Incomplete or Missing (Windows)



Check1 Are you using Page Layout Printing or Binding Margin function?

When the Page Layout Printing or Binding margin function is in use, thin lines may not be printed. Try thickening the lines in the document.

Check2 Is print data extremely large?

Click **Print Options** on **Page Setup** sheet of the printer driver. Then make sure **Prevention of Print Data Loss** is set to **On (Weak)** in the dialog that appears.

If printing does not start even though **Prevention of Print Data Loss** is set to **On (Weak)**, set it to **On (Strong)** and start printing again.

* This may reduce print quality.



Images Incomplete or Missing (Windows)



Check1 Select setting not to compress printing data.

If you select the setting not to compress the printing data with an application software you are using, the printing result may be improved.

Click **Print Options** on **Page Setup** sheet of the printer driver. Select **Do not allow application software to compress print data** check box and click **OK**.

* Clear the check box once printing is complete.

Check2 Is print data extremely large?

Click **Print Options** on **Page Setup** sheet of the printer driver. Then make sure **Prevention of Print Data Loss** is set to **On (Weak)** in the dialog that appears.

If printing does not start even though **Prevention of Print Data Loss** is set to **On (Weak)**, set it to **On (Strong)** and start printing again.

* This may reduce print quality.



Ink Blots / Paper Curl

Ink Blots



Paper Curl



Check1 Check paper and print quality settings.

 [Print Results Are Unsatisfactory](#)

Check2 Use Photo Paper to print photos.

To print data with high color saturation such as photographs or images with dark colors, we recommend that you use Photo Paper Plus Glossy II or other Canon specialty paper.

 [Media Types You Can Use](#)



Paper Is Smudged / Printed Surface Is Scratched

Paper Is Smudged

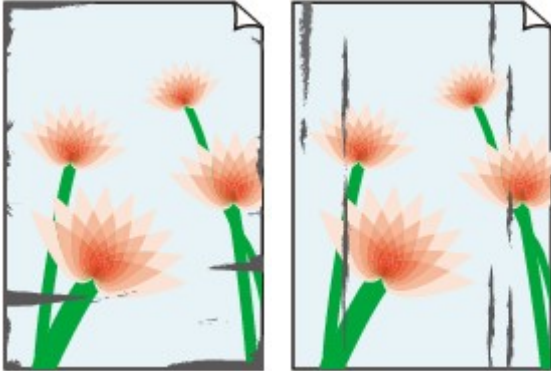

Smudged Edges

Smudged Surface



Printed Surface Is Scratched



Check1 Check paper and print quality settings.

[Print Results Are Unsatisfactory](#)

Check2 Check paper type.

- Make sure you are using the right paper for what you are printing.

 [Media Types You Can Use](#)

- For borderless printing, use a paper suitable for borderless printing.

If the paper you are using is not suitable for borderless printing, the print quality may be reduced at the top and bottom edges of the paper.

 [Printing Area](#)

Check3 Correct curl before loading paper.

When using Photo Paper Plus Semi-gloss, even if the sheet is curled, load one sheet at a time as it is. Rolling this paper in the opposite direction to flatten it may crack the paper surface and reduce the print quality.

We recommend putting unused paper back into the package and storing it flat.

- **Plain Paper**

Turn the paper over and reload it to print on the other side.

Leaving the paper loaded on the rear tray for a long time may cause the paper to curl. In this case, load the paper with the other side facing up. It may resolve the problem.

• Other Paper

If the paper corners curl more than 0.1 inch / 3 mm (A) in height, the paper may smudge or may not feed properly. Follow the instructions below to correct the paper curl.



1. Roll up paper in opposite direction to paper curl as shown below.



2. Check that paper is now flat.

We recommend printing curl-corrected paper one sheet at a time.

▶▶▶ Note

- Depending on paper type, the paper may smudge or may not feed properly even if it is not curled inward. Follow the instructions below to curl the paper outward up to 0.1 inch / 3 mm (B) in height before printing. This may improve the print result.

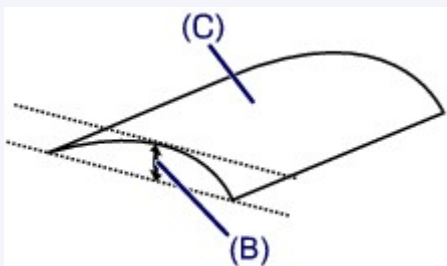

(C) Print side

We recommend feeding paper that has been curled outward one sheet at a time.

Check4 Set printer to prevent paper abrasion.

Adjusting the setting to prevent paper abrasion will widen the clearance between the print head and the paper. If you notice abrasion even with the media type set correctly to match the paper, set the printer to prevent paper abrasion using the operation panel.

* Once you have finished printing, undo this setting. Otherwise, it will apply to subsequent print jobs.

Press the **HOME** button, select **Various settings**, **Device settings**, and **Print settings**, and then set **Prevent paper abrasion** to **ON**.

[▶▶▶ Changing Settings from Operation Panel](#)

Check5 Specify a paper size that has 25 mm margins.

If the top or bottom edge of the printing surface has been scratched or smudged, print with a paper size that has wide margins (25 mm margins).

When you print on Photo Paper Pro Premium Matte PM-101 or Matte Photo Paper MP-101, we recommend that you print with a 25 mm margins paper size or 4" x 6" (10 x 15 cm) size.

Check6 Do not print outside recommended printing area.

If you print outside the recommended printing area of your paper, ink may stain the lower edge of the paper. Resize the document using application software.

[■ Printing Area](#)

Check7 Is paper feed roller dirty?

Clean the paper feed roller.

[■ Cleaning the Paper Feed Roller](#)

▶▶▶ Note

- Cleaning the paper feed roller abrades it, so do this only when necessary.

Check8 Is inside of printer dirty?

During duplex printing, ink may stain the inside of the printer, smudging the printout. Perform the bottom plate cleaning to clean the inside of the printer.

[■ Cleaning the Inside of the Printer \(Bottom Plate Cleaning\)](#)

▶▶▶ Note

- To prevent staining inside the printer, be sure to set the correct paper size.

Check9 Increase the print interval.

Increasing the print interval allows the printed surface to dry, preventing smudges and scratches.

Press the **HOME** button, select **Various settings**, **Device settings**, and **Advanced paper settings**. Select a media type, select **Pause between pages**, and then select a interval setting.

▶▶▶ Note

- Alternatively, press the **HOME** button, select , and select **Advanced** on **Rear tray paper information** screen to display **Pause between pages** screen.



Back of Paper Is Smudged

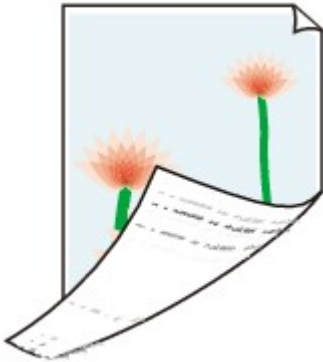

Check1 Check paper and print quality settings.

■ [Print Results Are Unsatisfactory](#)

Check2 Perform bottom plate cleaning to clean inside of printer.

■ [Cleaning the Inside of the Printer \(Bottom Plate Cleaning\)](#)

▶▶▶ Note

- During borderless printing, duplex printing, or too much printing, ink may stain the inside of the printer.



Vertical Line Next to Image



Check Is loaded paper size correct?

If the loaded paper is larger than the size you specified, a vertical line may appear in the margin. A small amount of ink is ejected for cleaning.

Set the paper size to match the loaded paper.

[Print Results Are Unsatisfactory](#)

Note

- The direction of the vertical line pattern may vary depending on the image data or the print setting.
- This printer performs automatic cleaning when necessary to keep printouts clean.

Although the ink is normally ejected onto the ink absorber at the outer edge of the paper, it may get onto the paper if the loaded paper is larger than the set size.



Uneven or Streaked Colors

Uneven Colors



Streaked Colors



Check1 Check paper and print quality settings.

[Print Results Are Unsatisfactory](#)

Check2 Print nozzle check pattern and perform any necessary maintenance operations such as print head cleaning.

Print the nozzle check pattern to determine whether the ink ejects properly from the print head nozzles.

For details on printing the nozzle check pattern, print head cleaning, print head deep cleaning, and system cleaning, see [Maintenance Procedure](#).

- If nozzle check pattern is not printed correctly:
 - Check if the ink tank for the problem color is empty.
 - If the ink tank is not empty, perform print head cleaning and try printing the nozzle check pattern again.
- If problem is not resolved after performing print head cleaning twice:
 - Perform print head deep cleaning.

- If problem is not resolved after performing print head deep cleaning:

Perform system cleaning manually.

If the problem is not resolved after performing the system cleaning manually, perform the print head deep cleaning after 24 hours later. If the problem is not resolved yet, the print head may be damaged. Contact your nearest Canon service center to request a repair.

▶▶▶ Note

- If you use the printer in the highlands, the blurs and the streaks may appear on the print result at regular intervals (about 2 to 3 months) by barometric effects. To prevent blur and streak, set **System cleaning frequency** to **Short** on the printer's operation panel.

System cleaning consumes many ink. Set **System cleaning frequency** to **Short** if necessary.

Check3 Perform print head alignment.

■ [Aligning the Print Head](#)

▶▶▶ Note

- If the problem is not resolved after performing the print head alignment, perform print head alignment manually. See [Aligning the Print Head Manually](#).

Check4 Make sure clear coating area setting.

- For Windows:

On **Main** sheet, select **Manual** for **Color/Intensity**, and then click **Set...**

If **Clear Coating Area** in **Clear Coating** sheet of the printer driver is set to **Auto**, Clear Coating may have an unexpected effect on the printing result depending on the image.

In this case, set **Clear Coating Area** to **Overall**.

■ [Changing the Clear Coating Settings](#)

- For Mac OS:

If **Clear Coating Area** in **Paper Detailed Settings** in the Print dialog is set to **Auto**, Clear Coating may have an unexpected effect on the printing result depending on the image.

In this case, set **Clear Coating Area** to **Overall**.

■ [Changing the Clear Coating Settings](#)



Small Dots of Ink Adheres to Margins of Paper



Check Is printer used in an environment with proper temperature and humidity?

If the printer is used in an environment with low temperature and humidity, small dots of ink are sprayed on the margins of paper due to static electricity.

When printing on the photo paper, you are recommended to use your printer in a proper environment. For details, see [Handling Paper](#).



Printed Colors Are Inaccurate

Check1 Adjust colors in printer driver.

- For Windows:

On **Main** sheet of the printer driver, select **Manual** for **Color/Intensity** and click **Set...** On **Color Adjustment** sheet, adjust the color.

- For Mac OS:

On **Color Options** in **Clear Coating** in the Print dialog, adjust the color.

Check2 Adjust colors on computer or monitor.

Refer to the instruction manuals of computer and monitor to adjust the colors.

Check3 Print nozzle check pattern and perform any necessary maintenance operations such as print head cleaning.

Print the nozzle check pattern to determine whether the ink ejects properly from the print head nozzles.

For details on printing the nozzle check pattern, print head cleaning, print head deep cleaning, and system cleaning, see [Maintenance Procedure](#).

- If nozzle check pattern is not printed correctly:

Check if the ink tank for the problem color is empty.

If the ink tank is not empty, perform print head cleaning and try printing the nozzle check pattern again.

- If problem is not resolved after performing print head cleaning twice:

Perform print head deep cleaning.

- If problem is not resolved after performing print head deep cleaning:

Perform system cleaning manually.

If the problem is not resolved after performing the system cleaning manually, perform the print head deep cleaning after 24 hours later. If the problem is not resolved yet, the print head may be damaged. Contact your nearest Canon service center to request a repair.

▶▶▶ Note

- If you use the printer in the highlands, the blurs and the streaks may appear on the print result at regular intervals (about 2 to 3 months) by barometric effects. To prevent blur and streak, set **System cleaning frequency** to **Short** on the printer's operation panel.

System cleaning consumes many ink. Set **System cleaning frequency** to **Short** if necessary.

Check4 Perform color calibration.

The print head characteristics gradually change through repeated use, and colors may change. There may be a slight difference in how colors are printed after the print head replacement because of individual variation among the print heads.

Perform color calibration to correct the color.

■ [Performing Color Calibration Using the Operation Panel](#)

»» Note

- Color may change slightly even on the same model of printer if you use a different version of the firmware or printer driver, or when you print under different settings or in a different printing environment. Prepare the printing environment before performing color calibration.



Documents Are Printed in Monochrome

Check1 Is monochrome print set on in printer driver?

- For Windows:
On **Main** sheet of the printer driver, clear **Black and White Photo Print** check box.
- For Mac OS:
On **Quality & Media** in the Print dialog, clear **Black and White Photo Print** check box.

Check2 Print nozzle check pattern and perform any necessary maintenance operations such as print head cleaning.

Print the nozzle check pattern to determine whether the ink ejects properly from the print head nozzles.

For details on printing the nozzle check pattern, print head cleaning, print head deep cleaning, and system cleaning, see [Maintenance Procedure](#).

- If nozzle check pattern is not printed correctly:
Check if the ink tank for the problem color is empty.
If the ink tank is not empty, perform print head cleaning and try printing the nozzle check pattern again.
- If problem is not resolved after performing print head cleaning twice:
Perform print head deep cleaning.
- If problem is not resolved after performing print head deep cleaning:
Perform system cleaning manually.

If the problem is not resolved after performing the system cleaning manually, perform the print head deep cleaning after 24 hours later. If the problem is not resolved yet, the print head may be damaged. Contact your nearest Canon service center to request a repair.

▶▶▶ Note

- If you use the printer in the highlands, the blurs and the streaks may appear on the print result at regular intervals (about 2 to 3 months) by barometric effects. To prevent blur and streak, set **System cleaning frequency** to **Short** on the printer's operation panel.
System cleaning consumes many ink. Set **System cleaning frequency** to **Short** if necessary.



No Ink Comes Out



Check1 Has ink run out?

■ [Checking the Ink Status with the LCD on the Printer](#)

Check2 Are print head nozzles clogged?

Print the nozzle check pattern to determine whether the ink ejects properly from the print head nozzles.

For details on printing the nozzle check pattern, print head cleaning, print head deep cleaning, and system cleaning, see [Maintenance Procedure](#).

- If nozzle check pattern is not printed correctly:

Check if the ink tank for the problem color is empty.

If the ink tank is not empty, perform print head cleaning and try printing the nozzle check pattern again.

- If problem is not resolved after performing print head cleaning twice:

Perform print head deep cleaning.

- If problem is not resolved after performing print head deep cleaning:

Perform system cleaning manually.

If the problem is not resolved after performing the system cleaning manually, perform the print head deep cleaning after 24 hours later. If the problem is not resolved yet, the print head may be damaged. Contact your nearest Canon service center to request a repair.

▶▶▶ Note

- If you use the printer in the highlands, the blurs and the streaks may appear on the print result at regular intervals (about 2 to 3 months) by barometric effects. To prevent blur and streak, set **System cleaning frequency** to **Short** on the printer's operation panel.

System cleaning consumes many ink. Set **System cleaning frequency** to **Short** if necessary.



Paper Does Not Feed Properly/"No Paper" Error



Check1 Make sure paper is loaded.

■ [Handling Paper](#)

Check2 When loading paper, consider the following.

- When loading two or more sheets of paper, flip through the paper before loading.



- When loading two or more sheets of paper, align the edges of the sheets before loading the paper.
- When loading two or more sheets of paper, make sure the paper stack does not exceed the paper load limit.

However, paper may not feed correctly at the maximum capacity, depending on the type of paper or environmental conditions (very high or low temperature and humidity). In such cases, reduce the amount of paper you load at a time to less than half of the paper load limit.

- Always load the paper in portrait orientation, regardless of the printing orientation.

In the manual feed tray:

When you load the paper, load one sheet at a time. When you print continuously, set the next paper after the last one is finished printing.

Check3 Is paper too thick or curled?

■ [Media Types You Cannot Use](#)

Check4 When loading postcards, consider the following:

- If a postcard is curled, it may not feed properly even though the paper stack does not exceed the paper load limit.

Load Japanese postcards with their postcode column downward.

Check5 Check paper source setting.

■ [Switching the Paper Source to Match the Purpose](#)

Check6 Make sure paper weight is suitable for use with printer.

■ [Media Types You Can Use](#)

Check7 Make sure there are not any foreign objects in rear tray or manual feed tray.



If the paper tears in the rear tray or the manual feed tray, see [Paper Jams](#) to remove it.

If there are any foreign objects in the rear tray or manual feed tray, be sure to turn off the printer, unplug it and remove the foreign object.



▶▶▶ Note

- If the feed slot cover is opened, close it slowly.

Check8 Clean paper feed roller.

■ [Cleaning the Paper Feed Roller](#)

▶▶▶ Note

- Cleaning the paper feed roller abrades it, so do this only when necessary.

If the measures above do not solve the problem, contact your nearest Canon service center to request a repair.



Printing Stops



Check1 Is paper loaded?

Make sure paper is loaded.

If necessary, load paper.

Check2 Do documents to be printed have many photographs or illustrations?

It takes time for the printer and the computer to process large data such as photos or other graphics, so it may seem that the printer is not working.

Also, if you are printing data that requires a lot of ink on successive sheets of plain paper, the printer may pause temporarily. In either case, wait until the process is complete.

▶▶▶ Note

- If you are printing a document with a large printing area or printing several copies, printing may pause to allow the ink to dry.

Check3 Has printer been printing continuously for a long period?

If the printer has been printing continuously for a long time, the print head or other parts around it may overheat. The printer may stop printing at a line break for a period of time and then resume printing.

In this case, wait a while without doing anything. If the printing does not resume, interrupt your print session and turn the printer off for at least 15 minutes.

⚠ Caution

- Print head and surrounding area can become extremely hot. Never touch print head or nearby components.



Cannot Print Using AirPrint



Check1 Make sure printer is turned on.

If the printer is turned on, turn it off and back on, and then check whether the issue is resolved.

Check2 Make sure printer is connected by LAN to same network subnet as AirPrint compliant device when printing over LAN.

Check3 Make sure printer has enough paper and ink.

Check4 Make sure no error message is displayed on printer's LCD.

If the problem is not resolved, use the printer driver on your computer to execute printing and check whether the document can be printed normally on the printer.



Paper Does Not Feed from Paper Source Specified in Printer Driver (Windows)



Check Is paper source setting inconsistent between application program and printer driver?

Change the application software setting corresponding to the printer driver setting, or click **Print Options** on **Page Setup** sheet of the printer driver and select **Disable the paper source setting of the application software** on **Print Options** screen.

When the paper source setting is inconsistent between an application program and the printer driver, the application software setting takes precedence.

Mechanical Problems

- ▶ **Power Does Not Come On**
- ▶ **Power Shuts Off By Itself**
- ▶ **USB Connection Problems**
- ▶ **Cannot Communicate with Printer via USB**
- ▶ **LCD Is Off**
- ▶ **LCD Shows Wrong Language**
- ▶ **Printer Status Monitor Not Displayed (Windows)**
- ▶ **It Takes a Long Time for Printer to Warm Up/Printer Is Making an Operation Noise**



Power Does Not Come On



Check1 Press **ON** button.

Check2 Make sure power plug is securely connected to printer, and then turn it back on.

Check3 Unplug printer, leave it for at least 3 minutes, and then plug it back in and turn it on again.

If this does not solve the problem, contact your nearest Canon service center to request a repair.



Power Shuts Off By Itself



Check If printer is set to turn off automatically after a certain time, disable this setting.

If you have set the printer to turn off automatically after a specified time, the power will shut off by itself once that time has elapsed.

- If you are using a Windows and if you do not want the printer to turn off automatically:

Open the printer driver setup window and in **Auto Power** in **Maintenance** sheet, select **Disable** for **Auto Power Off**.

- If you are using a Mac OS and if you do not want the printer to turn off automatically:

Open Canon IJ Printer Utility, select **Power Settings** in the pop-up menu, and then select **Disable** for **Auto Power Off** on **Auto Power**.

»» Note

- You can also enable the printer to turn on/off automatically from the operation panel.

 [Energy saving settings \(Item for administrator\)](#)

USB Connection Problems

Q Printing Is Slow/Hi-Speed USB Connection Does Not Work/"This device can perform faster" Message Appears (Windows)

A

If your system environment does not support Hi-Speed USB, the printer operates at the slower speed of USB 1.1. In this case, the printer works properly but printing speed may slow down due to the communication speed.

Check Check following to make sure your system environment supports Hi-Speed USB connection.

- Does the USB port on your computer support Hi-Speed USB connection?
- Does the USB cable or the USB hub support Hi-Speed USB connection?

Be sure to use a certified Hi-Speed USB cable. We recommend that the USB cable be no longer than 10 feet / 3 meters or so.

- Does the operating system of your computer support Hi-Speed USB connection?

Install the latest update for your computer.

- Is the Hi-Speed USB driver working properly?

If necessary, obtain and install the latest version of the Hi-Speed USB driver for your computer.

»» Important

- For more information, contact the manufacturer of your computer, USB cable, or USB hub.



Cannot Communicate with Printer via USB



Check1 Make sure printer is turned on.

Check2 Connect USB cable properly.

As the illustration below, the USB port is at the side of the printer.



Check3 Make sure **Enable bidirectional support** is selected in **Ports** sheet of properties dialog box of printer driver. (Windows)

■ ■ How to Open the Printer Driver Setup Window



LCD Is Off



- **If POWER lamp is off:**

The printer is not powered on. Check that the power cord is connected and press the **ON** button.

- **If POWER lamp is lit:**

The LCD may be in screen-saver mode. Press any button on the operation panel.



LCD Shows Wrong Language



Follow the instructions below to select your language.

1. Press **HOME** button and wait for about 5 seconds.

2. Select  **Various settings** on HOME screen.

 [LCD and Operation Panel](#)

3. Press **OK** button.

4. Press ▼ button 7 times and press **OK** button.

5. Use ▲▼ button to select a language for LCD and press **OK** button.



Printer Status Monitor Not Displayed (Windows)



Check Is printer status monitor enabled?

Make sure **Enable Status Monitor** is selected on the **Option** menu of the printer status monitor.

1. Open printer driver setup window.
 - ■ How to Open the Printer Driver Setup Window
2. On **Maintenance** sheet, click **View Printer Status**.
3. Select **Enable Status Monitor** on **Option** menu if it is not selected.



It Takes a Long Time for Printer to Warm Up/Printer Is Making an Operation Noise



Check1 If it takes a long time for printer to warm up after print job is sent, wait until printing starts.

To clean the clogged print head nozzles, the printer is set to perform the system cleaning automatically on a regular basis. While the function is performed, printing does not start. Wait until the system cleaning is finished.

Check2 If it takes a long time for printer to warm up after replacing ink tanks, wait until warm-up operation is finished.

To equalize the density of ink, the printer is set to automatic ink quality maintenance for stirring ink automatically on a regular basis. While the ink is stirred, printing does not start. Wait until the operation is finished.

Check3 When printer is making an operation noise, wait until operation noise stops.

If the printer is turned off for some time, it may make an operation noise to start printing. Wait until the printer stops making an operation noise.

Installation and Download Problems

- ▶ **Cannot Install Printer Driver**
- ▶ **Easy-WebPrint EX Does Not Start or Easy-WebPrint EX Menu Does Not Appear (Windows)**
- ▶ **Updating Printer Driver in Network Environment (Windows)**
- ▶ **Uninstalling IJ Network Device Setup Utility (Windows)**



Cannot Install Printer Driver



■ [For Windows:](#)

■ [For Mac OS:](#)

For Windows:

- **If installation does not start when you insert Setup CD-ROM:**

Follow the instructions below to start the installation.

1. Make the following settings.

- In Windows 8.1 or Windows 8, select the **Explorer** icon in **Taskbar** on **Desktop**, and then select **Computer** from list on left.
- In Windows 7 or Windows Vista, click **Start**, and then click **Computer**.

2. Double-click  **CD-ROM** icon in the window that appears.

If the contents of the CD-ROM appear, double-click **MSETUP4.EXE**.

If you cannot install the printer driver with the Setup CD-ROM, install it from the Canon website.

▶▶ Note

- If the CD-ROM icon does not appear, try the following:
 - Remove the CD-ROM from your computer and reinsert it.
 - Restart your computer.

If the icon still does not appear, try a different disc and see if it appears. If it does, there is a problem with the Setup CD-ROM. Contact your nearest Canon service center to request a repair.

- If you cannot get past the Printer Connection screen:

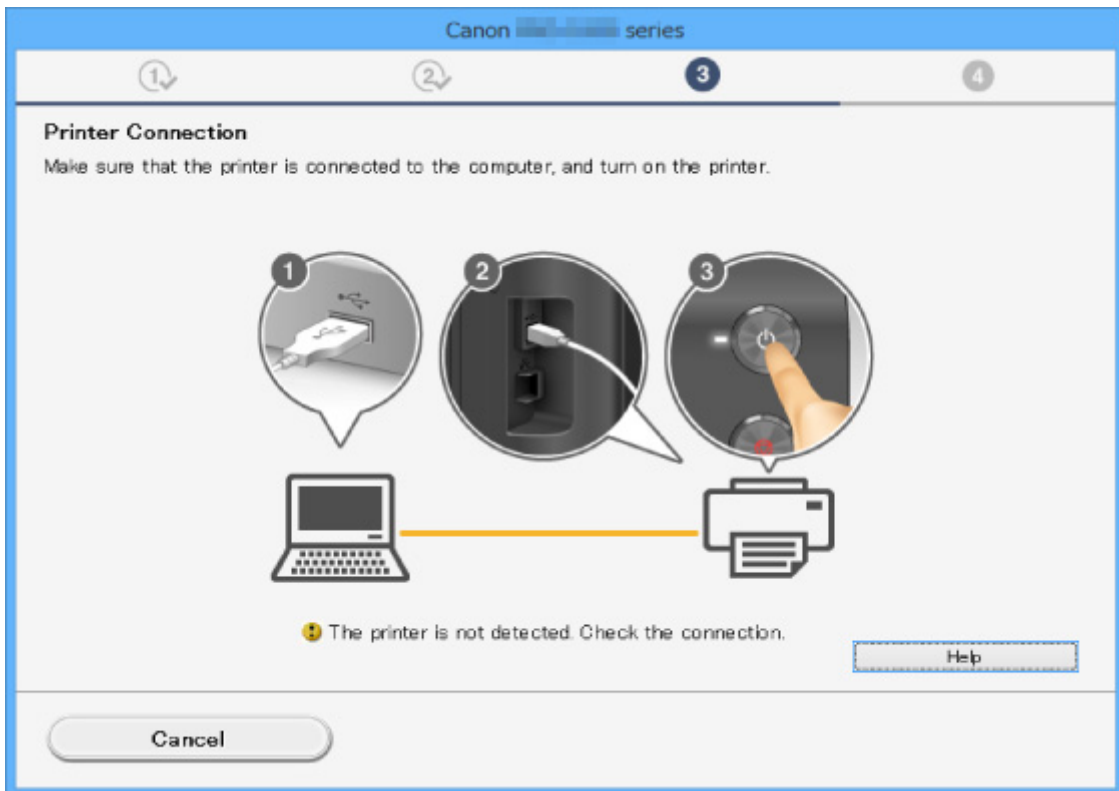

■ [Cannot Proceed beyond Printer Connection Screen](#)

- **Other cases:**

Reinstall the printer driver.

If the driver was not installed correctly, uninstall the printer driver, restart your computer, and then reinstall the driver.

■ [Deleting the Unnecessary Printer Driver](#)

Reinstall the printer driver with the Setup CD-ROM or install it from the Canon website.

▶▶▶ **Note**

- If the installer was stopped due to a Windows error, Windows operation may be unstable, and you may not be able to install the drivers. Restart your computer and then reinstall the drivers.

For Mac OS:

Download the driver from the support page of Canon website and reinstall it.



Easy-WebPrint EX Does Not Start or Easy-WebPrint EX Menu Does Not Appear (Windows)



If Easy-WebPrint EX does not start or its menu does not appear on Internet Explorer, check the following.

Check1 Is **Canon Easy-WebPrint EX** displayed on **Toolbars** menu in Internet Explorer's **View** menu?

If **Canon Easy-WebPrint EX** is not displayed, Easy-WebPrint EX is not installed on your computer. Install the latest version of Easy-WebPrint EX from the Canon website.

▶▶▶ Note

- If Easy-WebPrint EX is not installed, a message asking you to install it may appear in the notification area on the desktop. Click the message and follow the instructions to install Easy-WebPrint EX.
- Internet access is required to install or download Easy-WebPrint EX.

Check2 Is **Canon Easy-WebPrint EX** selected on **Toolbars** menu in Internet Explorer's **View** menu?

If **Canon Easy-WebPrint EX** is not selected, Easy-WebPrint EX is disabled. Select **Canon Easy-WebPrint EX** to enable it.

Check3 Check the following to make sure your system environment supports Easy-WebPrint EX.

- Is it installed on the computer with proper system requirements?
- Did you start it using a compatible version of Internet Explorer?

Visit Canon website for more information of the system requirements of Easy-WebPrint EX.



Updating Printer Driver in Network Environment (Windows)



Download the latest printer driver.

The latest printer driver for your model are available for download on the Canon website.

Uninstall the existing printer driver and follow the installation instructions to install the latest printer driver that you downloaded. In the connection method selection screen, select **Use the printer with wireless LAN connection** or **Use the printer with wired LAN connection** according to the connection method you use.

The printer is detected automatically in the network.

Make sure the printer was found, and install the printer driver following the on-screen instructions.

▶▶▶ Note

- The network settings on the printer are not affected, so the printer can be used on the network without redoing settings.



Uninstalling IJ Network Device Setup Utility (Windows)



To uninstall IJ Network Device Setup Utility from your computer, follow these steps.

»» Important

- Even if IJ Network Device Setup Utility is uninstalled, you can still use a network to print or scan from the computer. However, you cannot use the network to change the network settings.
- Log into a user account with administrator privileges.

1. To uninstall IJ Network Device Setup Utility, follow these steps.

- Windows 8.1 or Windows 8:
 1. Select **Control Panel** from **Settings** charm in **Desktop > Programs > Programs and Features**.
 2. Select **IJ Network Device Setup Utility** from program list, and then click **Uninstall**.
If **User Account Control** screen appears, click **Continue**.
- Windows 7 or Windows Vista:
 1. Click **Start > Control Panel > Programs > Programs and Features**.
 2. Select **IJ Network Device Setup Utility** from program list, and then click **Uninstall**.
If **User Account Control** screen appears, click **Continue**.

2. When confirmation message appears, click **Yes**.

When message appears saying to restart your computer, click **OK** and restart computer.

Errors and Messages

- ▶ **An Error Occurs**
- ▶ **Message Appears**
- ▶ **Error Message Appears on PictBridge (Wireless LAN) Compliant Device**
- ▶ **Checking Error History on Operation Panel**

An Error Occurs

If an error occurs in printing, for example if the paper runs out or jams, a troubleshooting message appears automatically. Take the appropriate action described in the message.

If an error occurs, a support code (error number) appears on the computer screen or the LCD.

When a Support Code and a Message Are Displayed on Computer Screen:

- For Windows:

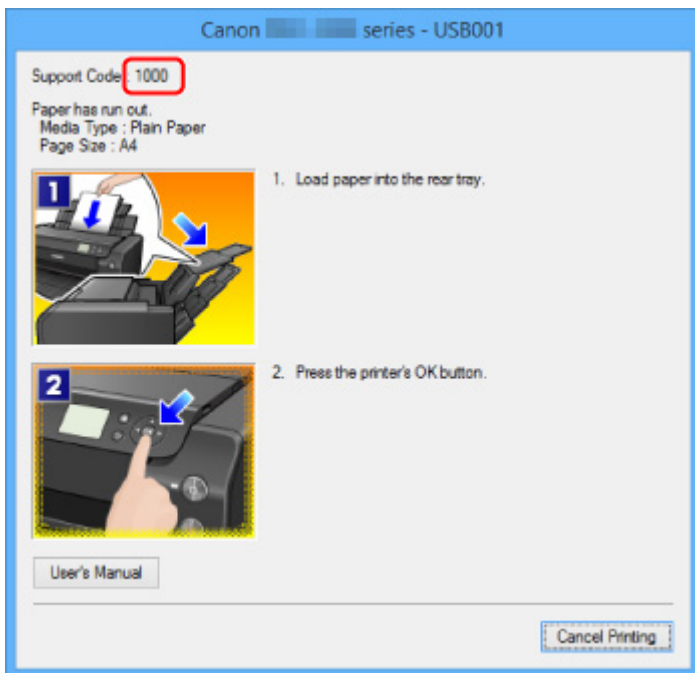

- For Mac OS:

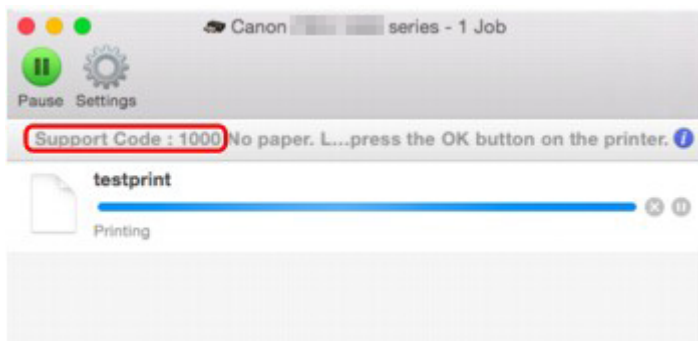

* The screen differs depending on the OS you are using.

When a Support Code and a Message Are Displayed on LCD:

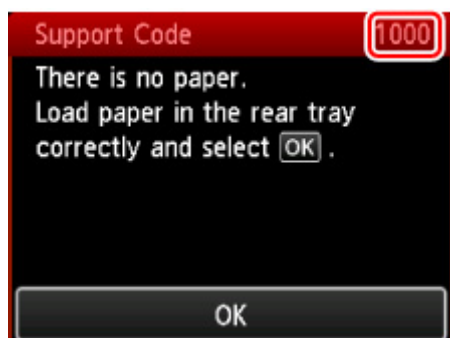

For more on resolving errors with support codes, see [List of Support Code for Error](#).

▶▶ Note

- You can also search for details on resolving the errors indicated by the support code shown.

■ [Search](#)

To resolve errors that do not have support codes, see [Message Appears](#).

Message Appears

This section describes some of the errors and messages that may appear.

►► Note

- A support code (error number) is displayed on the computer or on the LCD for some errors. For details on errors that have support code, see [List of Support Code for Error](#).

■ [Writing Error/Output Error/Communication Error \(Windows\)](#)

■ [Other Error Messages \(Windows\)](#)

■ [Inkjet Printer/Scanner/Fax Extended Survey Program Screen Is Displayed \(Windows\)](#)

■ [Inkjet Printer/Scanner/Fax Extended Survey Program Icon Appears \(Mac OS\)](#)



Writing Error/Output Error/Communication Error (Windows)



Check1 If **POWER** lamp is off, make sure printer is plugged in and turn it on.

The **POWER** lamp flashes while the printer is initializing. Wait until the **POWER** lamp stops flashing and remains lit.

Check2 Make sure correct printer port is set in printer driver.

* In the following instructions, "XXX" signifies your printer's name.

1. Log in using an account with administrator privileges.
2. Make the following settings.
 - In Windows 8.1 or Windows 8, select **Control Panel** from **Settings** charm on **Desktop** > **Hardware and Sound** > **Devices and Printers**.
 - In Windows 7, select **Devices and Printers** from **Start** menu.
 - In Windows Vista, select **Start** menu > **Control Panel** > **Hardware and Sound** > **Printers**.
3. Open printer driver properties.
 - In Windows 8.1, Windows 8, or Windows 7, right-click "Canon XXX series" icon (where "XXX" is your printer's name), and then select **Printer properties**.
 - In Windows Vista, right-click "Canon XXX series" icon (where "XXX" is your printer's name), and then select **Properties**.
4. Click **Ports** tab to check port settings.

Make sure a port named "USBnnn" (where "n" is a number) with "Canon XXX series" appearing in **Printer** column is selected for **Print to the following port(s)**.

- If setting is incorrect:
 - Reinstall the printer driver from the Setup CD-ROM or the Canon website.
- Printing does not start even though the printer is connected to the computer using a USB cable and the port named "USBnnn" is selected:

In Windows 8.1 or Windows 8, select **My Printer** on **Start** screen to start **My Printer**. If **My Printer** is not displayed on **Start** screen, select **Search** charm, and then search for "**My Printer**".

Set the correct printer port on **Diagnose and Repair Printer**. Follow the on-screen instructions to set the correct printer port, and then select your printer's name.

In Windows 7 or Windows Vista, click **Start** and select **All programs, Canon Utilities, Canon My Printer, Canon My Printer**, and then select **Diagnose and Repair Printer**. Follow the on-screen instructions to set the correct printer port, and then select your printer's name.

If the problem is not resolved, reinstall the printer driver from the Setup CD-ROM or the Canon website.

Check3 Make sure printer is properly connected to computer.

If you are using a USB cable, make sure it is securely connected to both the printer and the computer. When the USB cable is securely plugged in, check the following:

- If you are using a relay device such as a USB hub, disconnect it, connect the printer directly to the computer, and retry the printing. If printing starts normally, there is a problem with the relay device. Contact the vendor of the relay device.
- There could also be a problem with the USB cable. Replace the USB cable and retry the printing.

If you use the printer over a LAN, make sure the printer is connected to the network with a LAN cable or is correctly set up for network use.

Check4 Make sure printer driver is installed correctly.

Uninstall the printer driver following the procedure described in *Deleting the Unnecessary Printer Driver* and reinstall them from the Setup CD-ROM or the Canon website.

Check5 When printer is connected to your computer with a USB cable, check device status from your computer.

Follow the procedure below to check the device status.

1. Open the Device Manager on your computer as shown below.

If the **User Account Control** screen appears, follow the on-screen instructions.

- In Windows 8.1 or Windows 8, select **Control Panel** from **Settings** charm on **Desktop > Hardware and Sound > Device Manager**.
- In Windows 7 or Windows Vista, click **Control Panel, Hardware and Sound, and Device Manager**.

2. Double-click **Universal Serial Bus controllers** and **USB Printing Support**.

If the **USB Printing Support Properties** screen does not appear, make sure the printer is correctly connected to the computer.

 **Check3** [Make sure printer is properly connected to computer.](#)

3. Click **General** tab and check for a device problem.

If a device error is shown, see Windows Help to resolve it.

Other Error Messages (Windows)



Check If an error message appears outside printer status monitor, check the following:

- **"Could not spool successfully due to insufficient disk space"**

Delete any unnecessary files to increase the amount of free space on the disk.

- **"Could not spool successfully due to insufficient memory"**

Close other applications to increase the available memory.

If you still cannot print, restart your computer and retry the printing.

- **"Printer driver could not be found"**

Uninstall the printer driver following the procedure described in Deleting the Unnecessary Printer Driver and reinstall them from the Setup CD-ROM or the Canon website.

- **"Could not print Application name - File name"**

Try printing again once the current job is complete.

Q Inkjet Printer/Scanner/Fax Extended Survey Program Screen Is Displayed (Windows)

A

If the Inkjet Printer/Scanner/Fax Extended Survey Program is installed, a screen appears asking for permission to send the printer and application usage information every month for about ten years.

Read the information on the screen and follow the instructions below.

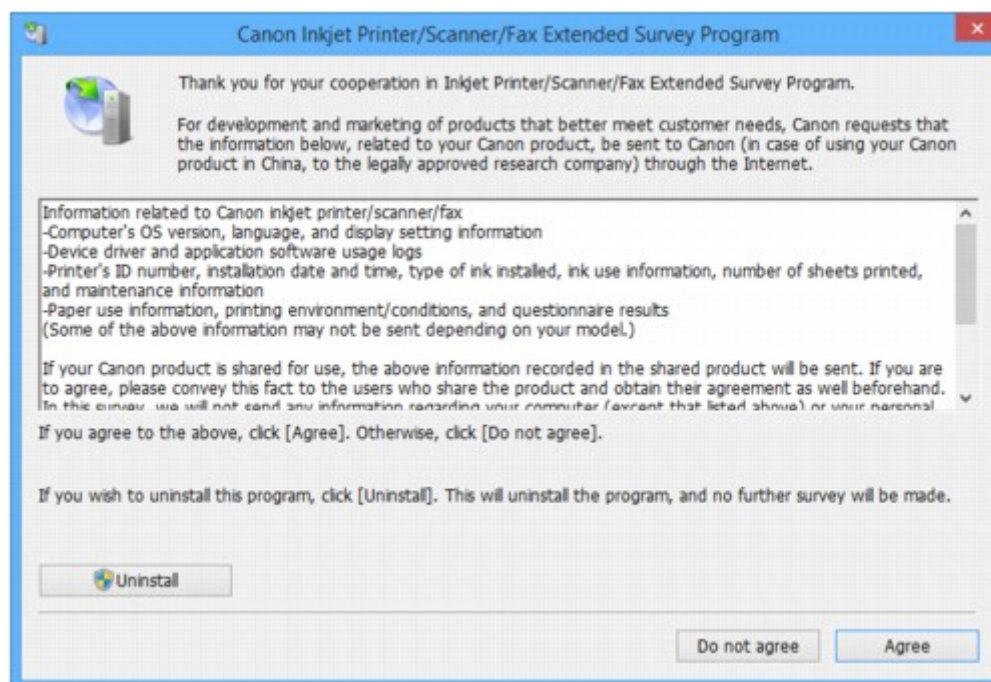

- **If you agree to participate in survey program:**

Click **Agree** and follow the on-screen instructions. The printer usage information is sent via the Internet. Once you have completed the procedure, the information is subsequently sent automatically and the confirmation screen does not reappear.

▶▶▶ Note

- When the information is being sent, a warning such as an Internet security message may appear. Make sure the program name is "IJPLMUI.exe" and allow it.

- If you clear **Send automatically from the next time** check box, the information will not be sent automatically from next time and a confirmation screen will appear at the time of the next survey. To send the information automatically, see [Changing confirmation screen setting](#).

- **If you do not agree to participate in survey program:**

Click **Do not agree**. The confirmation screen closes and the survey is skipped. The confirmation screen will reappear one month later.

- **To uninstall Inkjet Printer/Scanner/Fax Extended Survey Program:**

To uninstall the Inkjet Printer/Scanner/Fax Extended Survey Program, click **Uninstall** and follow the on-screen instructions.

- **Changing confirmation screen setting:**

1. Make the following settings.

- In Windows 8.1 or Windows 8, select **Control Panel** from **Settings** charm on **Desktop > Programs > Programs and Features**.
- In Windows 7, or Windows Vista, select **Start menu > Control Panel > Programs > Programs and Features**.

▶▶▶ Note

- A confirmation/warning dialog box may appear when installing, uninstalling or starting up software.

This dialog box appears when administrative rights are required to perform a task.

If you are logged in on an account with administrator privileges, follow the on-screen instructions.

2. Select **Canon Inkjet Printer/Scanner/Fax Extended Survey Program**.

3. Select **Change**.

If you select **Yes** after you have followed the on-screen instructions, the confirmation screen will appear at the time of the next survey.

If you select **No**, the information will be sent automatically.

▶▶▶ Note

- If you select **Uninstall**, the Inkjet Printer/Scanner/Fax Extended Survey Program is uninstalled. Follow the on-screen instructions.

Inkjet Printer/Scanner/Fax Extended Survey Program Icon Appears (Mac OS)



If the Inkjet Printer/Scanner/Fax Extended Survey Program is installed, the printer and application software usage information is sent every month for about ten years. The **Inkjet Printer/Scanner/Fax Extended Survey Program** icon appears in the Dock when it is time to send the printer usage information.

Click the icon, read the information that appears, and then follow the instructions below.

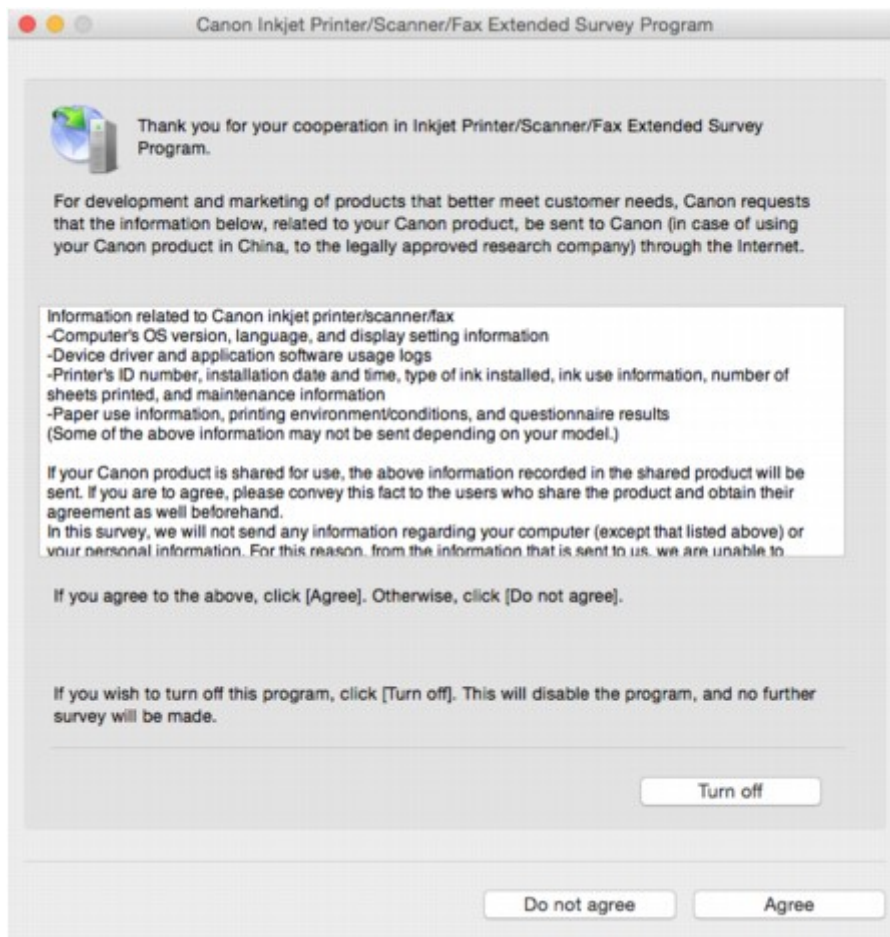

- **If you agree to participate in survey program:**

Click **Agree** and follow the on-screen instructions. The printer usage information is sent via the Internet. Once you have completed the procedure, the information is subsequently sent automatically and the confirmation screen does not reappear.

▶▶▶ **Note**

- If you clear **Send automatically from the next time** check box, the information will not be sent automatically the next time and the **Inkjet Printer/Scanner/Fax Extended Survey Program** icon will appear in the dock at the time of the next survey.

- **If you do not agree to participate in survey program:**

Click **Do not agree**. The confirmation screen closes and the survey is skipped. The confirmation screen will reappear one month later.

- **To stop sending information:**

Click **Turn off**. This stops the Inkjet Printer/Scanner/Fax Extended Survey Program, and information is not sent. To resume the survey, see [Changing setting:](#)

- **To uninstall Inkjet Printer/Scanner/Fax Extended Survey Program:**

1. Stop Inkjet Printer/Scanner/Fax Extended Survey Program.

■ [Changing setting:](#)

2. Select **Applications** from **Go** menu of Finder, double-click **Canon Utilities** folder and **Inkjet Extended Survey Program** folder.

3. Move **Canon Inkjet Printer/Scanner/Fax Extended Survey Program.app** file to **Trash**.
4. Restart computer.
Empty **Trash** and restart your computer.

- **Changing setting:**

To display the confirmation screen every time the printer usage information is sent or to resume surveying, follow the procedure below.

1. Select **Applications** from **Go** menu of Finder, double-click **Canon Utilities** folder and **Inkjet Extended Survey Program** folder.
2. Double-click **Canon Inkjet Printer/Scanner/Fax Extended Survey Program** icon.

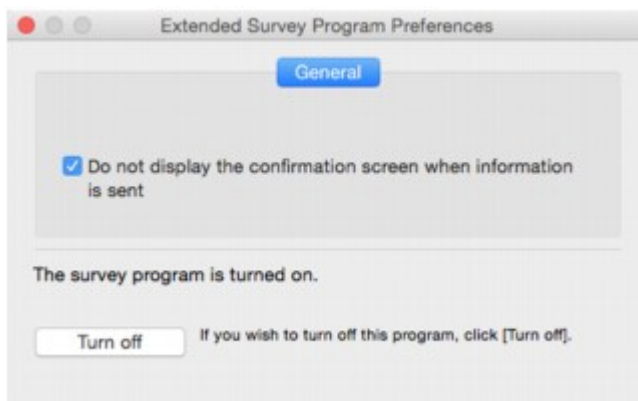

- **Do not display the confirmation screen when information is sent:**

If the check box is selected, the information will be sent automatically.

If the check box is not selected, **Inkjet Printer/Scanner/Fax Extended Survey Program** icon will appear in the Dock at the time of the next survey. Click the icon and follow the on-screen instructions.

- **Turn off/Turn on** button:

Click the **Turn off** button to stop the Inkjet Printer/Scanner/Fax Extended Survey Program.

Click the **Turn on** button to restart the Inkjet Printer/Scanner/Fax Extended Survey Program.



Error Message Appears on PictBridge (Wireless LAN) Compliant Device



The following errors may occur when you print directly from a PictBridge (Wireless LAN) compliant device. Follow the instructions below to resolve them.

▶▶▶ Note

- This section describes errors that appear on Canon-brand PictBridge (Wireless LAN) compliant devices. The error messages and operations may vary depending on the device you are using. For errors on other brands of PictBridge (Wireless LAN) compliant devices, check the support code (error number) on the LCD and take the appropriate action to clear the error.

■ ■ [List of Support Code for Error](#)

- For the errors indicated on the PictBridge (Wireless LAN) compliant device and their solution, also refer to the instruction manual of the device. For other device problems, contact the manufacturer.

Error Message on PictBridge (Wireless LAN) Compliant Device	What to Do
"Printer in use"	<p>If the printer is printing from the computer or warming up, wait until it finishes.</p> <p>When it is ready, the printer starts automatically.</p> <p>If the printer is not printing from a computer or warming up, check the support code on the LCD and take the appropriate action to resolve the error.</p> <p>■ ■ List of Support Code for Error</p>
"No paper"	<p>Load paper and select Continue* in the display of your PictBridge (Wireless LAN) compliant device.</p> <p>* Alternatively, load paper and press the OK button on the printer to resume printing.</p>
"Paper Error"/"Media type error"	<p>Check the support code on the LCD and take the appropriate action to resolve the error.</p> <p>■ ■ List of Support Code for Error</p>
"Paper jam"	<p>Select Stop in the display of your PictBridge (Wireless LAN) compliant device to stop printing.</p> <p>Remove the jammed paper, load new paper, press the OK button on the printer, and try printing again.</p>
"Printer cover open"	<p>Check the support code on the LCD and take the appropriate action to resolve the error.</p> <p>■ ■ List of Support Code for Error</p>
"No print head"	<p>The print head is defective or is not installed.</p> <p>Check the support code on the LCD and take the appropriate action to resolve the error.</p> <p>■ ■ List of Support Code for Error</p>

"No ink"/"Ink cassette error"	<p>Check the support code on the LCD and take the appropriate action to resolve the error.</p> <p>■ ■ List of Support Code for Error</p>
"Ink Error"	<p>Check the support code on the LCD and take the appropriate action to resolve the error.</p> <p>■ ■ List of Support Code for Error</p>
"Hardware Error"	<p>Check the support code on the LCD and take the appropriate action to resolve the error.</p> <p>■ ■ List of Support Code for Error</p>
"Printer error"	<p>An error requiring servicing may have occurred.</p> <p>Turn off the printer and unplug it.</p> <p>Plug in the printer again and turn it back on.</p> <p>If this does not solve the problem, contact your nearest Canon service center to request a repair.</p>

Checking Error History on Operation Panel

Follow the instructions below to display the error history.

1. [Make sure printer is turned on.](#)

2. Select  **Printer information** on HOME screen.

 [LCD and Operation Panel](#)

3. Use ▲▼ button to select **Error history** and press **OK** button.

Up to 5 error histories is displayed.

For details on the support code, see [List of Support Code for Error](#).

If You Cannot Solve a Problem

If there is a problem that you cannot solve following the instructions in this chapter, contact Canon through the Support page of the Canon website or contact your nearest Canon service center.

Canon support staff are trained to be able to provide technical support to satisfy customers.

Caution

- If the printer emits any unusual sound, smoke, or odor, turn it off immediately. Unplug the printer and contact the seller you bought it from or your nearest Canon service center. Never attempt to repair or disassemble the printer yourself.
- If you attempt to repair or take apart the printer, your warranty will be invalidated even if it has not expired.

Before contacting the service center, note the following:

- Product name
(Your printer's name is written on the front cover of the setup manual.)
- Serial number (see setup manual)
- Details of problem
- What you tried to solve the problem, and what happened

List of Support Code for Error

Support code appears on the LCD and your computer screen when errors occur.

A "support code" is an error number, and appears along with an error message.

When an error occurs, check the support code displayed on the LCD and computer screen and take the appropriate action in response.

Support Code Appears on LCD and Computer Screen

- **1000 to 1ZZZ**

[1000](#) [1006](#) [1062](#) [1200](#) [1201](#) [1204](#)

[1205](#) [1206](#) [1207](#) [1208](#) [1209](#) [1250](#)

[1261](#) [1270](#) [1293](#) [1300](#) [1340](#) [1401](#)

[1403](#) [1405](#) [1406](#) [1407](#) [1408](#) [1409](#)

[140A](#) [140B](#) [140C](#) [140D](#) [140E](#) [140F](#)

[1410](#) [1411](#) [1412](#) [1413](#) [1414](#) [1415](#)

[1416](#) [1417](#) [1418](#) [1419](#) [141A](#) [141B](#)

[1466](#) [1467](#) [1491](#) [1493](#) [1551](#) [1552](#)

[1600](#) [1660](#) [1681](#) [1684](#) [1720](#) [1721](#)

[1722](#) [1730](#) [1731](#) [1751](#) [1752](#) [1753](#)

[1880](#) [1881](#) [1890](#)

- **2000 to 2ZZZ**

[2102](#) [2103](#) [2114](#) [2123](#) [2500](#) [2501](#)

[2502](#) [2503](#)

- **3000 to 3ZZZ**

[3000](#) [3250](#) [3306](#) [3310](#) [3311](#) [3312](#)

[3313](#) [3314](#) [3315](#) [3316](#) [3317](#) [3318](#)

[3319](#) [3413](#)

- **4000 to 4ZZZ**

[4100](#) [4103](#) [4109](#) [4111](#)

- **5000 to 5ZZZ**

[5100](#) [5110](#) [5200](#) [520A](#) [520B](#) [520C](#)

[520D](#) [5250](#) [5400](#) [5403](#) [5700](#) [5701](#)

[5B16](#) [5C00](#) [5C01](#) [5C10](#) [5C11](#) [5C12](#)

[5C13](#) [5C14](#) [5C20](#)

• **6000 to 6ZZZ**

[6000](#) [6500](#) [6502](#) [6700](#) [6701](#) [6800](#)

[6801](#) [6900](#) [6901](#) [6902](#) [6910](#) [6911](#)

[6920](#) [6921](#) [6930](#) [6931](#) [6932](#) [6933](#)

[6940](#) [6941](#) [6942](#) [6943](#) [6944](#) [6945](#)

[6946](#) [6F00](#)

• **7000 to 7ZZZ**

[7400](#) [7401](#) [7402](#)

• **8000 to 8ZZZ**

[8100](#) [8200](#)

• **A000 to ZZZZ**

[B202](#) [B203](#) [B204](#) [B205](#) [B206](#) [B207](#)

[B208](#) [B209](#) [B400](#) [B505](#) [B506](#) [B507](#)

[B600](#) [B801](#) [B802](#)

For paper jam support codes, see also [List of Support Code for Error \(Paper Jams\)](#).

List of Support Code for Error (Paper Jams)

If paper jams, remove it following the appropriate procedure as shown below.

- If you can see the jammed paper at the paper output slot, the rear tray, or the manual feed tray:

- [1300](#)

- If the paper tears and you cannot remove it from the paper output slot, from the rear tray, or from the manual feed tray:

- [Paper Is Jammed inside Printer](#)

- Cases other than above:

- [Other Cases](#)

1300

Cause

Paper is jammed in paper output slot, in rear tray, or in manual feed tray.

What to Do

Remove the jammed paper depending on the paper source.

- [If the paper loaded in the rear tray is jammed:](#)
- [If the paper loaded in the manual feed tray is jammed:](#)

- **If the paper loaded in the rear tray is jammed:**

1. Slowly pull out paper, either from paper output slot or from rear tray, whichever is easier.

Hold the paper with your hands and pull the paper out slowly not to tear it.



▶▶▶ Note

- If you cannot pull out the paper, turn the printer back on. The paper may be ejected automatically.
- If paper becomes jammed during printing and you need to turn off the printer to remove it, press the **Stop** button to stop the printing before you turn off the printer.
- If the paper tears and you cannot remove the jammed paper from the paper output slot or the rear tray, remove the paper from inside the printer.

- [Paper Is Jammed inside Printer](#)

2. Reload paper and press printer's **OK** button.

The printer resumes printing. Reprint the page you were printing if it was not printed properly due to the paper jam.

If you turned off the printer in step 1, the print data that was sent to the printer is erased. Redo the printing.

▶▶▶ Note

- When reloading the paper, make sure you are using suitable paper and loading it correctly.

- We recommend using paper sizes other than A5 to print documents with photos or graphics. A5 paper may curl and jam as it leaves the printer.

• **If the paper loaded in the manual feed tray is jammed:**

1. Press **Paper Jam Clearing** button and set manual feed tray to paper jam clearing position.

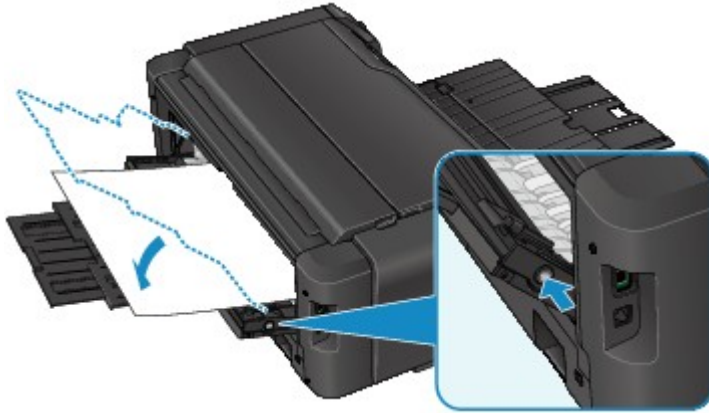

2. Slowly pull out paper, either from paper output slot or from manual feed tray, whichever is easier. Hold the paper with your hands and pull the paper out slowly not to tear it.



▶▶▶ **Note**

- If you cannot pull out the paper, turn the printer back on. The paper may be ejected automatically.
- If paper becomes jammed during printing and you need to turn off the printer to remove it, press the **Stop** button to stop the printing before you turn off the printer.
- If the paper tears and you cannot remove the jammed paper from the paper output slot or the manual feed tray, remove the paper from inside the printer.

■ [Paper Is Jammed inside Printer](#)

3. Return manual feed tray to original position.



4. Reload paper and press printer's **OK** button.

The printer resumes printing. Reprint the page you were printing if it was not printed properly due to the paper jam.

If you turned off the printer in step 2, the print data that was sent to the printer is erased. Redo the printing.

▶▶▶ Note

- When reloading the paper, make sure you are using suitable paper and loading it correctly.

If the measures above do not solve the problem, contact your nearest Canon service center to request a repair.

Paper Is Jammed inside Printer

If the jammed paper tears and you cannot remove the paper either from the paper output slot, from the rear tray, or from the manual feed tray, or if the jammed paper remains inside the printer, remove the paper following the instructions below.

▶▶▶ Note

- If paper becomes jammed during printing and you need to turn off the printer to remove it, press the **Stop** button to stop the printing before you turn off the printer.

1. Turn off printer and unplug it.
2. Open top cover.



▶▶▶ Important

- Do not touch clear film (A) or white belt (B).

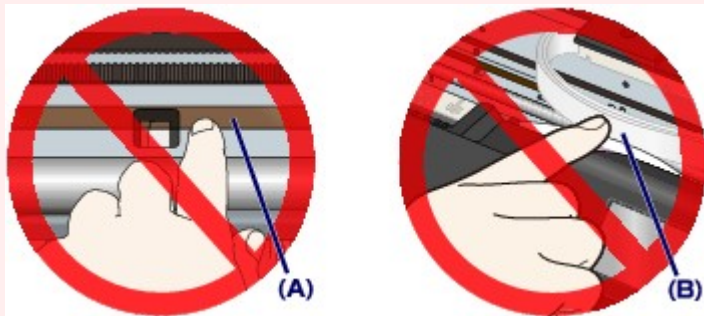

If you soil or scratch these parts by touching them with paper or your hand, it could damage the printer.

3. Check if jammed paper is under print head holder.

If the jammed paper is under the print head holder, move the print head holder to the far right or left, whichever makes it easier to remove the paper.

When moving the print head holder, hold the top of the print head holder and slide it slowly to the far right or left.

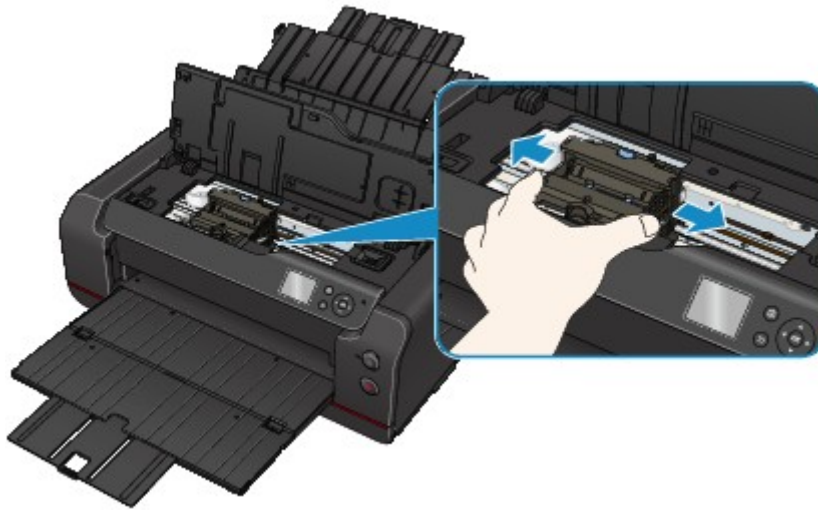

4. Hold jammed paper firmly in both hands.

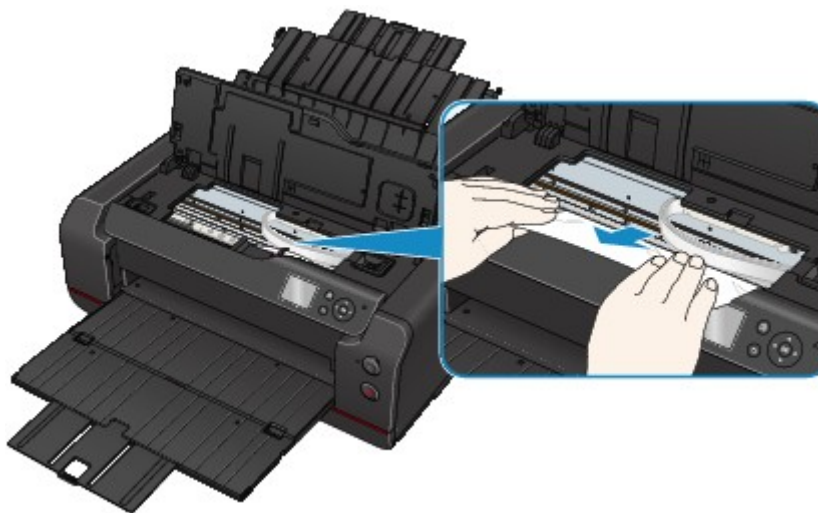

If the paper is rolled up, pull out it.

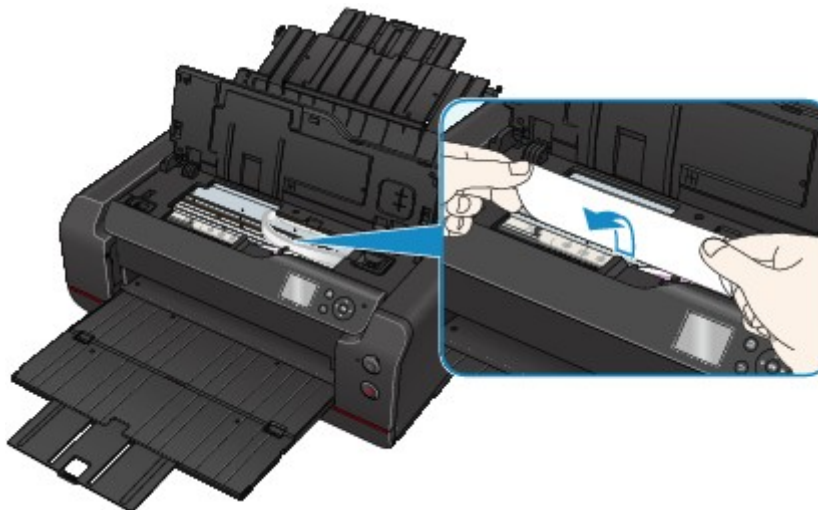

5. Slowly pull out paper, so as not to tear it.

Pull out the paper at an angle of about 45 degrees.

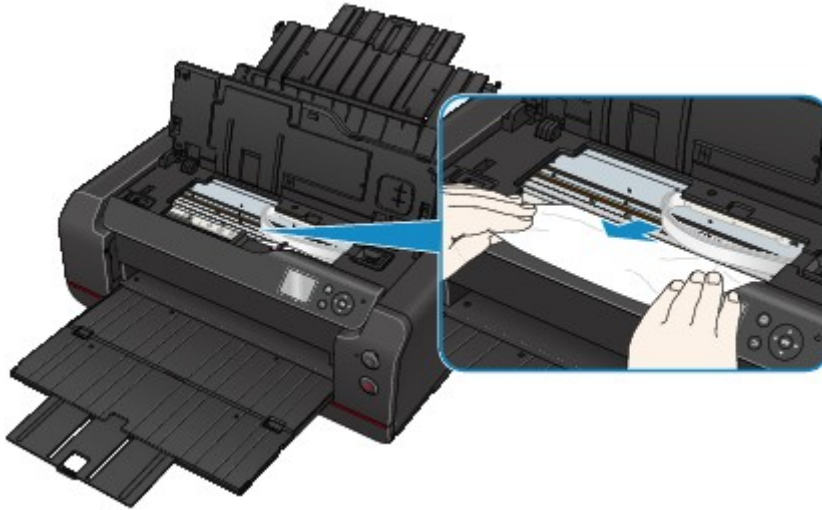

6. Make sure all jammed paper is removed.

If the paper tears when you pull out it, a bit of paper may remain in the printer. Check the following and remove any remaining paper.

- Any paper left under the print head holder?
- Any small bits of paper left in the printer?
- Any paper left in the left and right empty spaces (C) in the printer?

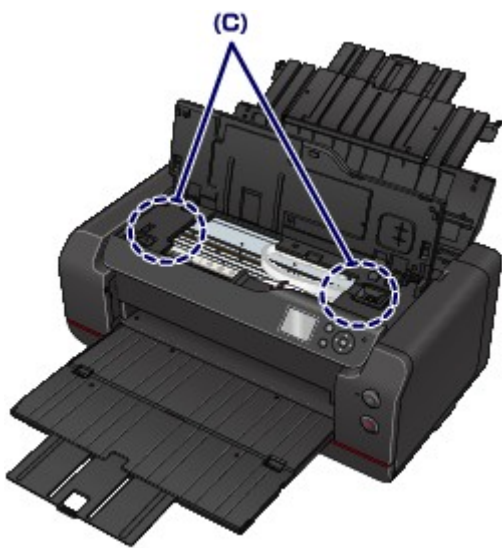

7. Close top cover.

All jobs in the print queue are canceled. Redo the printing.

Note

- When reloading the paper, make sure you are using suitable paper and loading it correctly. If a paper jam message appears on the LCD or on your computer screen when you resume printing after removing all the jammed paper, there may be some paper still inside the printer. Check the printer again for any remaining bits of paper.

If the measures above do not solve the problem, contact your nearest Canon service center to request a repair.

Other Cases

Check the following:

Check1 Is anything blocking paper output slot?

Check2 Are there any foreign objects in rear tray or manual feed tray?



If there are any foreign objects in the rear tray or the manual feed tray, be sure to turn off the printer, unplug it, and then remove the foreign object.



▶▶▶ Note

- If the feed slot cover is opened, close it slowly.

Check3 Is paper curled?

Correct curl before loading paper.

1000

Cause

Possible causes include the following.

- There is no paper in the rear tray.
- Paper is not loaded properly.

What to Do

Take the corresponding actions below.

- Load paper in the rear tray.
- Align the paper guides with the both edges of the paper when you load paper.

After carrying out the above measures, press the printer's **OK** button.

»» Important

- Be sure to close the feed slot cover after loading paper in the rear tray. If the feed slot cover is open, paper cannot be fed.

1006

Cause

Possible causes include the following.

- There is no paper in the manual feed tray.
- Paper is not loaded properly.

What to Do

Take the corresponding actions below.

- Load a sheet of paper in the manual feed tray.
- Align the paper guides with the both edges of the paper when you load paper.

After carrying out the above measures, press the printer's **OK** button.

▶▶ Note

- To continue printing from the manual feed tray, wait until printing is completed, and then load the next sheet.

1062

Cause

Page Size setting does not match size of loaded paper.

What to Do

Press the printer's **OK** button to clear the error.

Take the corresponding actions below.

- For Windows:

Check the **Page Size** setting in **Page Setup** sheet of the printer driver and load paper that is the same size as the setting and retry printing.

If this error occurs even you load paper of the same size as the setting, set the printer not to detect the width of the paper using the printer driver.

To set the printer not to detect the width of the paper, open the printer driver setup window, and in **Custom Settings** under **Maintenance** sheet, select **Disable paper width detection when printing from computer** check box, and then click **OK**.

* Clear **Disable paper width detection when printing from computer** check box again once printing is complete, and then click **OK**.

- For Mac OS:

Check **Paper Size** setting in the Page Setup dialog and load paper that is the same size as the setting and retry printing.

If this error occurs even you load paper of the same size as the setting, set the printer not to detect the width of the paper using the Canon IJ Printer Utility.

To set the printer not to detect the width of the paper, open the Canon IJ Printer Utility, select **Custom Settings** in the pop-up menu, select **Disable paper width detection when printing from computer** check box, and then click **Apply**.

* Clear the **Disable paper width detection when printing from computer** check box again once printing is complete, and then click **Apply**.

1200

Cause

Top cover is open.

What to Do

Close the top cover and wait for a while.

1201

Cause

Tank cover is open.

What to Do

Close the tank cover.

1204

Cause

Maintenance cover is open.

What to Do

Close the maintenance cover and wait for a while.

1205

Cause

Tank cover is open.

What to Do

Close the tank cover and wait for a while.

1206

Cause

Maintenance cover is open.

What to Do

Close the maintenance cover and press the printer's **OK** button.

1207

Cause

Tank cover is open.

What to Do

Close the tank cover.

1208

Cause

Maintenance cover is open.

What to Do

Close the maintenance cover and wait for a while.

1209

Cause

Maintenance cover is open.

What to Do

Close the maintenance cover and press the printer's **OK** button.

1250

Cause

Paper output tray is closed.

What to Do

Open the paper output tray and resume printing.

1261

Cause

Manual feed tray is in the paper jam clearing position.

What to Do

Return the manual feed tray to the paper feed position and press the printer's **OK** button.

1270

Cause

Feed slot cover is open.

What to Do

Slowly close the feed slot cover, and then press the printer's **OK** button.

1293

Cause

Tank cover is open.

What to Do

Close the tank cover.

1340

Cause

Ink supply stopper has not been stored properly.

What to Do

Place the printer on a flat surface as the ink supply stopper is stored properly, and then press the **OK** button.

1401

Cause

Print head is not installed.

What to Do

Install the print head.

If the print head is already installed, remove the print head once and then reinstall it.

If the error is still not resolved, the print head may be damaged. Contact your nearest Canon service center to request a repair.

1403

Cause

Type of print head is incorrect.

What to Do

Install the correct print head.

1405

Cause

Type of print head is incorrect.

What to Do

Install the correct print head.

1406

Cause

Print head error may occur.

What to Do

Turn off the printer and unplug it.

Contact your nearest Canon service center to request a repair.

1407

Cause

Print head error may occur.

What to Do

Turn off the printer and unplug it.

Contact your nearest Canon service center to request a repair.

1408

Cause

Print head cannot be recognized properly.

What to Do

Install the print head properly.

1409

Cause

Print head cannot be recognized properly.

What to Do

Install the print head properly.

140A

Cause

Print head cannot be recognized properly.

What to Do

Install the print head properly.

140B

Cause

Print head is not installed.

What to Do

Install the print head.

140C

Cause

Print head error may occur.

What to Do

Turn the printer off and turn it back on.

If this does not solve the problem, contact your nearest Canon service center to request a repair.

140D

Cause

Cannot install a print head that was installed on a different printer.

What to Do

Install an appropriate print head, and then close the top cover.

140E

Cause

Printer error has occurred.

What to Do

Turn the printer off and turn it back on.

If this does not solve the problem, contact your nearest Canon service center to request a repair.

140F

Cause

Print head error may occur.

What to Do

Turn off the printer and unplug it.

Contact your nearest Canon service center to request a repair.

1410

Cause

Ink tank cannot be recognized.

What to Do

Check the color of the ink tank that cannot be recognized.

Open the ink cover, remove the ink tank, and then reinstall it.

If the error is not resolved, replace the ink tank.

■ [Replacing Ink](#)

1411

Cause

Ink tank cannot be recognized.

What to Do

Check the color of the ink tank that cannot be recognized.

Open the ink cover, remove the ink tank, and then reinstall it.

If the error is not resolved, replace the ink tank.

■ [Replacing Ink](#)

1412

Cause

Ink tank cannot be recognized.

What to Do

Check the color of the ink tank that cannot be recognized.

Open the ink cover, remove the ink tank, and then reinstall it.

If the error is not resolved, replace the ink tank.

■ [Replacing Ink](#)

1413

Cause

Ink tank cannot be recognized.

What to Do

Check the color of the ink tank that cannot be recognized.

Open the ink cover, remove the ink tank, and then reinstall it.

If the error is not resolved, replace the ink tank.

■ [Replacing Ink](#)

1414

Cause

Ink tank cannot be recognized.

What to Do

Check the color of the ink tank that cannot be recognized.

Open the ink cover, remove the ink tank, and then reinstall it.

If the error is not resolved, replace the ink tank.

■ [Replacing Ink](#)

1415

Cause

Ink tank cannot be recognized.

What to Do

Check the color of the ink tank that cannot be recognized.

Open the ink cover, remove the ink tank, and then reinstall it.

If the error is not resolved, replace the ink tank.

■ [Replacing Ink](#)

1416

Cause

Ink tank cannot be recognized.

What to Do

Check the color of the ink tank that cannot be recognized.

Open the ink cover, remove the ink tank, and then reinstall it.

If the error is not resolved, replace the ink tank.

■ [Replacing Ink](#)

1417

Cause

Ink tank cannot be recognized.

What to Do

Check the color of the ink tank that cannot be recognized.

Open the ink cover, remove the ink tank, and then reinstall it.

If the error is not resolved, replace the ink tank.

■ [Replacing Ink](#)

1418

Cause

Ink tank cannot be recognized.

What to Do

Check the color of the ink tank that cannot be recognized.

Open the ink cover, remove the ink tank, and then reinstall it.

If the error is not resolved, replace the ink tank.

■ [Replacing Ink](#)

1419

Cause

Ink tank cannot be recognized.

What to Do

Check the color of the ink tank that cannot be recognized.

Open the ink cover, remove the ink tank, and then reinstall it.

If the error is not resolved, replace the ink tank.

■ [Replacing Ink](#)

141A

Cause

Ink tank cannot be recognized.

What to Do

Check the color of the ink tank that cannot be recognized.

Open the ink cover, remove the ink tank, and then reinstall it.

If the error is not resolved, replace the ink tank.

■ [Replacing Ink](#)

141B

Cause

Ink tank cannot be recognized.

What to Do

Check the color of the ink tank that cannot be recognized.

Open the ink cover, remove the ink tank, and then reinstall it.

If the error is not resolved, replace the ink tank.

■ [Replacing Ink](#)

1466

Cause

Print head is not compatible with this printer.

What to Do

Install an appropriate print head.

1467

Cause

Print head error may occur.

What to Do

Turn off the printer and unplug it.

Contact your nearest Canon service center to request a repair.

1491

Cause

Print head nozzles are clogged.

What to Do

Press the printer's **OK** button, and then clean the print head.

■ [Cleaning the Print Head](#)

1493

Cause

Maintenance cartridge cannot be recognized properly.

What to Do

Remove the maintenance cartridge, and then reinstall it.

If the error is not resolved, install the proper maintenance cartridge and press the printer's **OK** button.

1551

Cause

Used genuine Canon ink tanks were detected.

What to Do

Press the printer's **OK** button.

1552

Cause

Genuine Canon ink tanks have been installed.

What to Do

Press the printer's **OK** button.

1600

Cause

If printing is continued, the ink may run out.

What to Do

You are recommended to replace the ink tank.

If printing is in progress and you want to continue printing, press the printer's **OK** button. Then printing can continue. In this case, if the ink runs out during printing, printing will be interrupted even if the paper is half-printed, and the paper will be ejected.

1660

Cause

An ink tank is not installed.

What to Do

Install the ink tank.

1681

Cause

More than one ink tank of the same color is installed.

What to Do

Make sure the ink tanks are installed in the appropriate positions.

1684

Cause

The ink tank cannot be recognized.

What to Do

Printing cannot be executed because the ink tank may not be installed properly or may not be compatible with this printer.

Install the appropriate ink tank.

If you want to cancel printing, press the printer's **Stop** button.

1720

Cause

The maintenance cartridge is full.

What to Do

It needs to be replaced.

Replace the maintenance cartridge.

■ [Replacing the Maintenance Cartridge](#)

1721

Cause

The maintenance cartridge is not installed.

What to Do

Install the maintenance cartridge and press the printer's **OK** button.

1722

Cause

Cannot install a maintenance cartridge that was installed on a different printer.

What to Do

Install the proper maintenance cartridge, and then press the printer's **OK** button.

1730

Cause

The ink tank may be an ink tank that ran out of genuine Canon ink or a counterfeit Canon ink tank.

What to Do

To print, you must replace the ink tank or disable the function for detecting the remaining ink level. To disable the function for detecting the remaining ink level, press and hold the printer's **Stop** button for at least 5 seconds, and then release it.

By this operation, the fact that you have disabled the function for detecting the remaining ink level will be memorized. Please be advised that Canon shall not be liable for any malfunction or trouble caused by continuation of printing under the ink out condition or by using refilled ink tanks.

▶▶ Note

- If the function for detecting the remaining ink level is disabled, the ink tank in gray is displayed on the LCD when checking the current ink level.

To report the counterfeit ink tank, access Canon website from the following link.

■ Report Counterfeit

1731

Cause

Non-genuine Canon ink tank has been detected.

What to Do

To print, you must replace the ink tank or disable the function for detecting the remaining ink level. To disable the function for detecting the remaining ink level, press and hold the printer's **Stop** button for at least 5 seconds, and then release it.

By this operation, the fact that you have disabled the function for detecting the remaining ink level will be memorized. Please be advised that Canon shall not be liable for any malfunction or trouble caused by using a non-genuine Canon ink tank.

▶▶ Note

- If the function for detecting the remaining ink level is disabled, the ink tank in gray is displayed on the LCD when checking the current ink level.

To report the counterfeit ink tank, access Canon website from the following link.

■ Report Counterfeit

1751

Cause

The ink has run out.

Printing was interrupted and the paper was ejected because printing under the current condition may damage the printer.

What to Do

Open the tank cover, and then replace the ink tank. Printing will restart from the next page.

■ [Replacing Ink](#)

1752

Cause

The ink has run out.

Printing was interrupted and the paper was ejected because printing under the current condition may damage the printer.

What to Do

Open the tank cover, and then replace the ink tank. Printing will restart from the next page.

■ [Replacing Ink](#)

1753

Cause

The remaining level of the ink cannot be correctly detected.

What to Do

Replace the ink tank. Printing will restart.

[Replacing Ink](#)

An ink tank that was once empty is installed.

If you want to continue printing, you need to disable the function for detecting the remaining ink level.

To disable this function, press and hold the printer's **Stop** button for at least 5 seconds, and then release it.

With this operation, disabling the function for detecting the remaining ink level is memorized.

Please be advised that Canon shall not be liable for any malfunction or trouble caused by continuation of printing under the ink out condition or by using refilled ink tanks.

1880

Cause

Joint lever is not closed properly.

What to Do

Close the joint lever following the procedure below.

1. Open top cover.
2. Push joint lever securely.

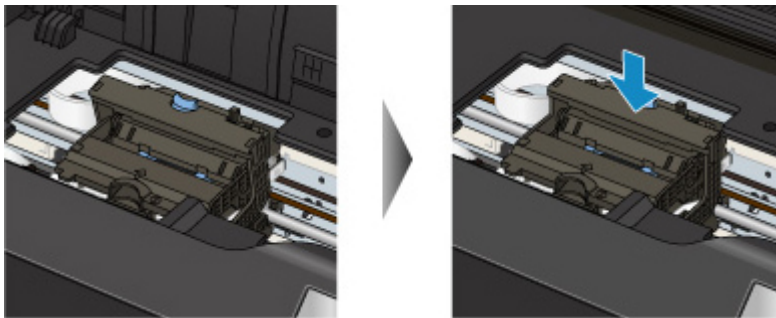

▶▶ Note

- Push the joint lever until it clicks into place.

3. Close top cover.

1881

Cause

Joint lever is not closed properly.

What to Do

Close the joint lever following the procedure below.

1. Open top cover.
2. Push joint lever securely.

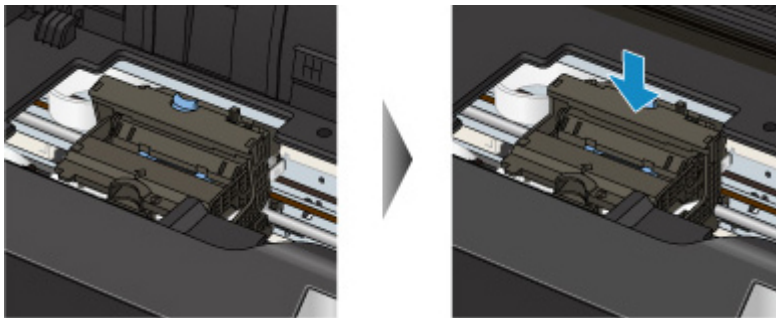

▶▶ Note

- Push the joint lever until it clicks into place.

3. Close top cover.

1890

Cause

Protective material or tape may still be attached to print head holder.

What to Do

Open the top cover and make sure the protective material and tape have been removed from the print head holder.

If the protective material or tape is still there, remove it and close the top cover.

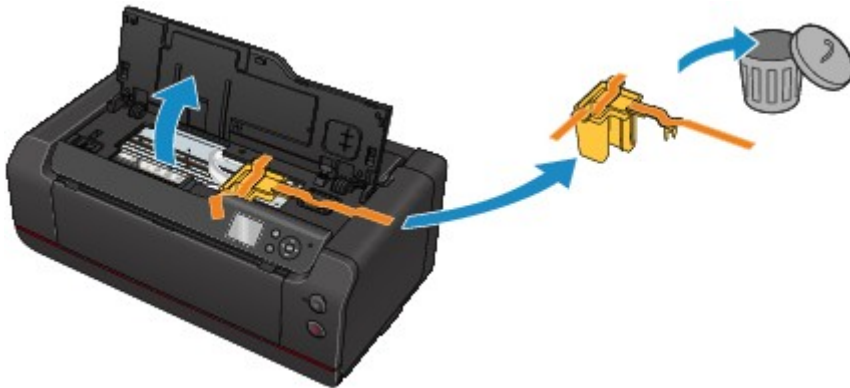

If this does not solve the problem, contact your nearest Canon service center to request a repair.

2102

Cause

Printer has detected that paper has been fed aligned to one side.

What to Do

Load the paper into the center of the rear tray or the manual feed tray, and then slide the paper guides to align with the both edges of the paper stack.

Press the printer's **OK** button.

2103

Cause

Printer cannot detect paper size.

What to Do

Press the printer's **Stop** button and retry printing.

If this error still occurs even after printing again, set the printer not to detect the paper width using the operation panel, the printer driver, or Remote UI.

▶▶ Note

- For more on setting printer not to detect the paper width using the operation panel, see below.

■ [Paper-related settings](#)

- Depending on the type of paper, the printer may not detect the paper width.

If the top cover is opened while printing is in progress, the printer may not detect the paper width.

2114

Cause

Paper settings for printing differ from rear tray paper information set on printer.

▶▶▶ Note

- See below for the correct correspondence between paper settings made on the printer driver or on the LCD.
 - [Paper Settings on the Printer Driver and the Printer \(Media Type\) \(Windows\)](#)
 - [Paper Settings on the Printer Driver and the Printer \(Media Type\) \(Mac OS\)](#)
 - [Paper Settings on the Printer Driver and the Printer \(Paper Size\) \(Windows\)](#)
 - [Paper Settings on the Printer Driver and the Printer \(Paper Size\) \(Mac OS\)](#)
- See below for more on the rear tray paper information that is set on the printer.
 - [Paper Settings](#)

If the print paper settings do not match the rear tray paper information set on the printer, as shown below, a message appears on the LCD.

- Print settings specified on the printer driver:
 - Paper size: A5
 - Media type: Plain paper
- Cassette paper information set on the printer:
 - Paper size: A4
 - Media type: Plain paper

After pressing the printer's **OK** button, the print paper settings appear below the message.

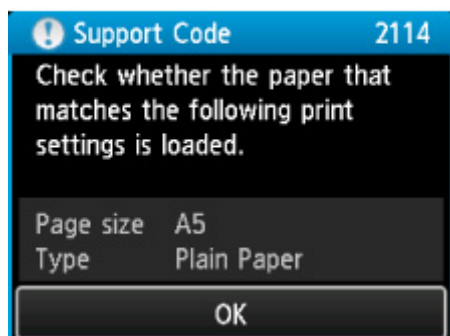
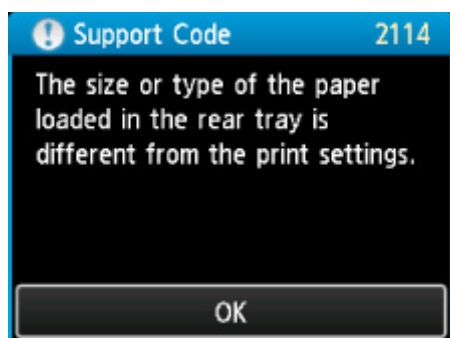

What to Do

Pressing the printer's **OK** button again, the screen below appears on the LCD.

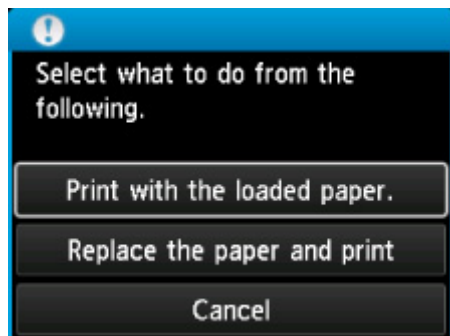

Select the appropriate action.

▶▶▶ Note

- All of the options below may not appear, depending on the setting.

Print with the loaded paper.

Select this option to print on the paper in the rear tray, without changing the paper settings.

For example, if the paper setting is A5, and A4 is set in the rear tray paper information, the A5 size setting is used to print on the A4 paper in the rear tray.

Replace the paper and print

Select this option to print after changing the paper in the rear tray.

For example, if the paper setting is A5, and A4 is set in the rear tray paper information, change the paper in the rear tray to A5 paper and proceed with printing.

Once you have changed the paper and closed the feed slot cover, the screen for setting the rear tray paper information appears. Set the paper information for the paper in the rear tray.

▶▶▶ Note

- If you do not know what paper information to set, press the **Back** button. The previous screen appears, showing the paper size and media type. Check the paper settings and set them as the rear tray paper information.
- See below for the correct correspondence between paper settings made on the printer driver or on the LCD.

■ Paper Settings on the Printer Driver and the Printer (Media Type) (Windows)

■ [Paper Settings on the Printer Driver and the Printer \(Media Type\)](#) (Mac OS)

■ Paper Settings on the Printer Driver and the Printer (Paper Size) (Windows)

■ [Paper Settings on the Printer Driver and the Printer \(Paper Size\)](#) (Mac OS)

Cancel

Cancels printing.

Select this option to change the print paper settings. Change the paper settings and retry the printing.

▶▶▶ Note

- To suppress the misprint prevention message, change the setting as described below. When you suppress the message, the printer uses the paper settings to print on the paper in the rear tray, even if the paper does not match the settings.

- To change the message view setting when printing using the printer's operation panel:

- [Paper-related settings](#)

- To change the message view setting when printing using the printer driver:

- [Changing the Printer Operation Mode \(Windows\)](#)

- [Changing the Printer Operation Mode \(Mac OS\)](#)

2123

Cause

Rear tray paper settings are incomplete.

What to Do

If screen below is shown, the rear tray paper settings are incomplete.

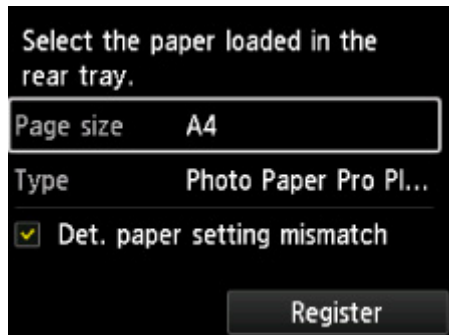

Select **Register** and press the printer's **OK** button to finish setting the rear tray paper settings.

2500

Cause

Cause of following may have occurred failure of automatic print head alignment.

- Print head nozzles are clogged.
- Size of paper loaded is incorrect.
- Paper output slot is exposed to strong light.

What to Do

Press the printer's **OK** button and take the corresponding actions below.

- Check the print head condition by printing the nozzle check pattern.
If there are missing lines or horizontal white streaks in the pattern, the print head nozzles are clogged.
Clean the print head.
- Load the correct size paper and perform automatic print head alignment again.
- Adjust your operating environment and/or the position of the printer so that the paper output slot is not exposed directly to strong light.

►► Important

- The highly permeable paper such as a backlight film or the plain paper are not available for automatic print head alignment.

Use the lower permeable paper or the frequently used paper.

After carrying out the above measures, if the problem continues after aligning the print head again, press the printer's **OK** button, and then perform manual print head alignment.

2501

Cause

Cause of following may have occurred failure of color calibration.

- Print head nozzles are clogged.
- Paper is dirty or size of paper loaded is incorrect.
- Paper output slot is exposed to strong light.

What to Do

Press the printer's **OK** button and take the corresponding actions below.

- Check the print head condition by printing the nozzle check pattern.
If there are missing lines or horizontal white streaks in the pattern, the print head nozzles are clogged.
Clean the print head.
- Load the clean and correct size paper, and then perform the color calibration again.
- Adjust your operating environment and/or the position of the printer so that the paper output slot is not exposed directly to strong light.

2502

Cause

Cannot perform calibration.

What to Do

Press the printer's **OK** button, and then perform the calibration again.

If this does not solve the problem, contact your nearest Canon service center to request a repair.

2503

Cause

Printing does not start correctly.

What to Do

Press the printer's **OK** button, and then restart printing.

3000

Cause

Print head alignment is required.

What to Do

If you perform the print head alignment now, select **Yes** and press the printer's **OK** button.

3250

Cause

The maintenance cartridge is almost full.

What to Do

Prepare a new maintenance cartridge because an error may occur if you continue to use the printer while the maintenance cartridge is full.

3306

Cause

Printer's media information cannot be properly recognized because it is broken.

What to Do

Start up Media Configuration Tool and restore the printer's media information.

■ Starting the Media Configuration Tool

After selecting your printer and clicking **OK** in Media Configuration Tool, Media Configuration Tool will be in recovery mode.

Specify the media information backup file and import it.

If the media information backup file has not been saved, contact your nearest Canon service center to request a repair.

3310

Cause

Print data is incorrect.

What to Do

Press the printer's **OK** button, and then retry printing.

If you are using a print program such as RIP (Raster Image Processor), contact the manufacturer of the print program.

3311

Cause

Print data is incorrect.

What to Do

Press the printer's **OK** button, and then retry printing.

If you are using a print program such as RIP (Raster Image Processor), contact the manufacturer of the print program.

3312

Cause

Print data is incorrect.

What to Do

Press the printer's **OK** button, and then retry printing.

If you are using a print program such as RIP (Raster Image Processor), contact the manufacturer of the print program.

3313

Cause

Print data is incorrect.

What to Do

Press the printer's **OK** button, and then retry printing.

If you are using a print program such as RIP (Raster Image Processor), contact the manufacturer of the print program.

3314

Cause

Print data is incorrect.

What to Do

Press the printer's **OK** button, and then retry printing.

If you are using a print program such as RIP (Raster Image Processor), contact the manufacturer of the print program.

3315

Cause

Print data is incorrect.

What to Do

Press the printer's **OK** button, and then retry printing.

If you are using a print program such as RIP (Raster Image Processor), contact the manufacturer of the print program.

3316

Cause

Print data is incorrect.

What to Do

Press the printer's **OK** button, and then retry printing.

If you are using a print program such as RIP (Raster Image Processor), contact the manufacturer of the print program.

3317

Cause

Print data is incorrect.

What to Do

Press the printer's **OK** button, and then retry printing.

If you are using a print program such as RIP (Raster Image Processor), contact the manufacturer of the print program.

3318

Cause

Print data is incorrect.

What to Do

Press the printer's **OK** button, and then retry printing.

If you are using a print program such as RIP (Raster Image Processor), contact the manufacturer of the print program.

3319

Cause

Print data is incorrect.

What to Do

Press the printer's **OK** button, and then retry printing.

If you are using a print program such as RIP (Raster Image Processor), contact the manufacturer of the print program.

3413

Cause

Prevent paper abrasion has been set.

What to Do

If you continue printing in the current setting, select **Yes** and press the **OK** button.

If you disable this setting, select **No** and press the printer's **OK** button. Press the **HOME** button, select **Various settings**, **Device settings**, and **Print settings**, and then set **Prevent paper abrasion** to **OFF**.

4100

Cause

Specified data cannot be printed.

What to Do

If you are printing CREATIVE PARK PREMIUM contents, check the message shown your computer, make sure genuine Canon ink tanks are installed properly for all colors, and retry the printing.

4103

Cause

Cannot perform printing with current print settings.

What to Do

Press the printer's **Stop** button to cancel printing.

Then change the print settings and retry printing.

4109

Cause

Paper size that cannot be fed from manual feed tray is specified.

What to Do

Press the printer's **OK** button.

Check the paper size that can be fed from the manual feed tray, and then reprint.

■ [Handling Paper](#)

4111

Cause

Unsupported media type is specified.

What to Do

Press the printer's **OK** button.

Check the media type, and then reprint.

5100

Cause

Printer error has occurred.

What to Do

Cancel printing, and turn off the printer. Then clear the jammed paper or protective material that is preventing the print head holder from moving, and turn on the printer again.

If this does not solve the problem, contact your nearest Canon service center to request a repair.

▶▶▶ Important

- When clearing an impediment to print head holder motion, be careful not to touch clear film (A) or white belt (B).

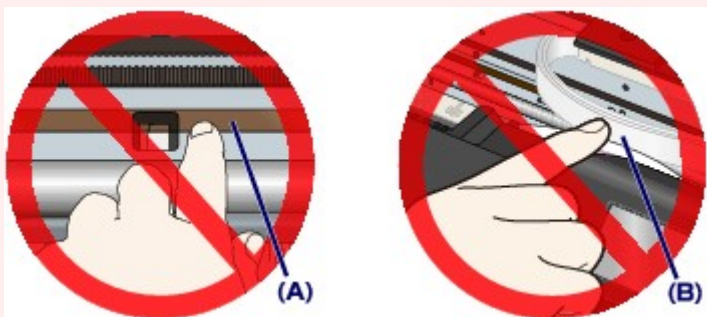

If you soil or scratch these parts by touching them with paper or your hand, it could damage the printer.

5110

Cause

Printer error has occurred.

What to Do

Turn off the printer and unplug it.

Plug in the printer again and turn it back on.

If this does not solve the problem, contact your nearest Canon service center to request a repair.

5200

Cause

Printer error has occurred.

What to Do

Turn off the printer and unplug it.

Plug in the printer again and turn it back on.

If this does not solve the problem, contact your nearest Canon service center to request a repair.

5250

Cause

Printer error has occurred.

What to Do

Turn off the printer and unplug it.

Plug in the printer again and turn it back on.

If this does not solve the problem, contact your nearest Canon service center to request a repair.

520A

Cause

Printer error has occurred.

What to Do

Turn off the printer and unplug it.

Plug in the printer again and turn it back on.

If this does not solve the problem, contact your nearest Canon service center to request a repair.

520B

Cause

Printer error has occurred.

What to Do

Turn off the printer and unplug it.

Plug in the printer again and turn it back on.

If this does not solve the problem, contact your nearest Canon service center to request a repair.

520C

Cause

Printer error has occurred.

What to Do

Turn off the printer and unplug it.

Plug in the printer again and turn it back on.

If this does not solve the problem, contact your nearest Canon service center to request a repair.

520D

Cause

Printer error has occurred.

What to Do

Turn off the printer and unplug it.

Plug in the printer again and turn it back on.

If this does not solve the problem, contact your nearest Canon service center to request a repair.

5400

Cause

Printer error has occurred.

What to Do

Turn off the printer and unplug it.

Plug in the printer again and turn it back on.

If this does not solve the problem, contact your nearest Canon service center to request a repair.

5403

Cause

Printer error has occurred.

What to Do

Turn off the printer and unplug it.

Plug in the printer again and turn it back on.

If this does not solve the problem, contact your nearest Canon service center to request a repair.

5700

Cause

Printer error has occurred.

What to Do

Turn off the printer and unplug it.

Plug in the printer again and turn it back on.

If this does not solve the problem, contact your nearest Canon service center to request a repair.

5701

Cause

Printer error has occurred.

What to Do

Turn off the printer and unplug it.

Plug in the printer again and turn it back on.

If this does not solve the problem, contact your nearest Canon service center to request a repair.

5B16

Cause

Printer error has occurred.

What to Do

Turn off the printer and unplug it.

Plug in the printer again and turn it back on.

If this does not solve the problem, contact your nearest Canon service center to request a repair.

5C00

Cause

Printer error has occurred.

What to Do

Turn off the printer and unplug it.

Plug in the printer again and turn it back on.

If this does not solve the problem, contact your nearest Canon service center to request a repair.

5C01

Cause

Printer error has occurred.

What to Do

Turn off the printer and unplug it.

Plug in the printer again and turn it back on.

If this does not solve the problem, contact your nearest Canon service center to request a repair.

5C10

Cause

Printer error has occurred.

What to Do

Turn off the printer and unplug it.

Plug in the printer again and turn it back on.

If this does not solve the problem, contact your nearest Canon service center to request a repair.

5C11

Cause

Printer error has occurred.

What to Do

Turn off the printer and unplug it.

Plug in the printer again and turn it back on.

If this does not solve the problem, contact your nearest Canon service center to request a repair.

5C12

Cause

Printer error has occurred.

What to Do

Turn off the printer and unplug it.

Plug in the printer again and turn it back on.

If this does not solve the problem, contact your nearest Canon service center to request a repair.

5C13

Cause

Printer error has occurred.

What to Do

Turn off the printer and unplug it.

Plug in the printer again and turn it back on.

If this does not solve the problem, contact your nearest Canon service center to request a repair.

5C14

Cause

Printer error has occurred.

What to Do

Turn off the printer and unplug it.

Plug in the printer again and turn it back on.

If this does not solve the problem, contact your nearest Canon service center to request a repair.

5C20

Cause

Printer error has occurred.

What to Do

Turn off the printer and unplug it.

Plug in the printer again and turn it back on.

If this does not solve the problem, contact your nearest Canon service center to request a repair.

6000

Cause

Printer error has occurred.

What to Do

Turn off the printer and unplug it.

Plug in the printer again and turn it back on.

If this does not solve the problem, contact your nearest Canon service center to request a repair.

6500

Cause

Printer error has occurred.

What to Do

Turn off the printer and unplug it.

Plug in the printer again and turn it back on.

If this does not solve the problem, contact your nearest Canon service center to request a repair.

6502

Cause

Printer error has occurred.

What to Do

Turn off the printer and unplug it.

Plug in the printer again and turn it back on.

If this does not solve the problem, contact your nearest Canon service center to request a repair.

6700

Cause

Printer error has occurred.

What to Do

Turn off the printer and unplug it.

Plug in the printer again and turn it back on.

If this does not solve the problem, contact your nearest Canon service center to request a repair.

6701

Cause

Printer error has occurred.

What to Do

Turn off the printer and unplug it.

Plug in the printer again and turn it back on.

If this does not solve the problem, contact your nearest Canon service center to request a repair.

6800

Cause

Printer error has occurred.

What to Do

Turn off the printer and unplug it.

Plug in the printer again and turn it back on.

If this does not solve the problem, contact your nearest Canon service center to request a repair.

6801

Cause

Printer error has occurred.

What to Do

Turn off the printer and unplug it.

Plug in the printer again and turn it back on.

If this does not solve the problem, contact your nearest Canon service center to request a repair.

6900

Cause

Printer error has occurred.

What to Do

Turn off the printer and unplug it.

Plug in the printer again and turn it back on.

If this does not solve the problem, contact your nearest Canon service center to request a repair.

6901

Cause

Printer error has occurred.

What to Do

Turn off the printer and unplug it.

Plug in the printer again and turn it back on.

If this does not solve the problem, contact your nearest Canon service center to request a repair.

6902

Cause

Printer error has occurred.

What to Do

Turn off the printer and unplug it.

Plug in the printer again and turn it back on.

If this does not solve the problem, contact your nearest Canon service center to request a repair.

6910

Cause

Printer error has occurred.

What to Do

Turn off the printer and unplug it.

Plug in the printer again and turn it back on.

If this does not solve the problem, contact your nearest Canon service center to request a repair.

6911

Cause

Printer error has occurred.

What to Do

Turn off the printer and unplug it.

Plug in the printer again and turn it back on.

If this does not solve the problem, contact your nearest Canon service center to request a repair.

6920

Cause

Printer error has occurred.

What to Do

Turn off the printer and unplug it.

Plug in the printer again and turn it back on.

If this does not solve the problem, contact your nearest Canon service center to request a repair.

6921

Cause

Printer error has occurred.

What to Do

Turn off the printer and unplug it.

Plug in the printer again and turn it back on.

If this does not solve the problem, contact your nearest Canon service center to request a repair.

6930

Cause

Printer error has occurred.

What to Do

Turn off the printer and unplug it.

Plug in the printer again and turn it back on.

If this does not solve the problem, contact your nearest Canon service center to request a repair.

6931

Cause

Printer error has occurred.

What to Do

Turn off the printer and unplug it.

Plug in the printer again and turn it back on.

If this does not solve the problem, contact your nearest Canon service center to request a repair.

6932

Cause

Printer error has occurred.

What to Do

Turn off the printer and unplug it.

Plug in the printer again and turn it back on.

If this does not solve the problem, contact your nearest Canon service center to request a repair.

6933

Cause

Printer error has occurred.

What to Do

Turn off the printer and unplug it.

Plug in the printer again and turn it back on.

If this does not solve the problem, contact your nearest Canon service center to request a repair.

6940

Cause

Printer error has occurred.

What to Do

Turn off the printer and unplug it.

Plug in the printer again and turn it back on.

If this does not solve the problem, contact your nearest Canon service center to request a repair.

6941

Cause

Printer error has occurred.

What to Do

Turn off the printer and unplug it.

Plug in the printer again and turn it back on.

If this does not solve the problem, contact your nearest Canon service center to request a repair.

6942

Cause

Printer error has occurred.

What to Do

Turn off the printer and unplug it.

Plug in the printer again and turn it back on.

If this does not solve the problem, contact your nearest Canon service center to request a repair.

6943

Cause

Printer error has occurred.

What to Do

Turn off the printer and unplug it.

Plug in the printer again and turn it back on.

If this does not solve the problem, contact your nearest Canon service center to request a repair.

6944

Cause

Printer error has occurred.

What to Do

Turn off the printer and unplug it.

Plug in the printer again and turn it back on.

If this does not solve the problem, contact your nearest Canon service center to request a repair.

6945

Cause

Printer error has occurred.

What to Do

Turn off the printer and unplug it.

Plug in the printer again and turn it back on.

If this does not solve the problem, contact your nearest Canon service center to request a repair.

6946

Cause

Printer error has occurred.

What to Do

Turn off the printer and unplug it.

Plug in the printer again and turn it back on.

If this does not solve the problem, contact your nearest Canon service center to request a repair.

6F00

Cause

Printer error has occurred.

What to Do

Turn off the printer and unplug it.

Plug in the printer again and turn it back on.

If this does not solve the problem, contact your nearest Canon service center to request a repair.

7400

Cause

Printer error has occurred.

What to Do

Turn off the printer and unplug it.

Plug in the printer again and turn it back on.

If this does not solve the problem, contact your nearest Canon service center to request a repair.

7401

Cause

Printer error has occurred.

What to Do

Turn off the printer and unplug it.

Plug in the printer again and turn it back on.

If this does not solve the problem, contact your nearest Canon service center to request a repair.

7402

Cause

Printer error has occurred.

What to Do

Turn off the printer and unplug it.

Plug in the printer again and turn it back on.

If this does not solve the problem, contact your nearest Canon service center to request a repair.

8100

Cause

Printer error has occurred.

What to Do

Turn off the printer and unplug it.

Plug in the printer again and turn it back on.

If this does not solve the problem, contact your nearest Canon service center to request a repair.

8200

Cause

Printer error has occurred.

What to Do

Turn off the printer and unplug it.

Plug in the printer again and turn it back on.

If this does not solve the problem, contact your nearest Canon service center to request a repair.

B202

Cause

An error requiring a repair has occurred.

What to Do

Turn off the printer and unplug it.

Contact your nearest Canon service center to request a repair.

B203

Cause

An error requiring a repair has occurred.

What to Do

Turn off the printer and unplug it.

Contact your nearest Canon service center to request a repair.

B204

Cause

An error requiring a repair has occurred.

What to Do

Turn off the printer and unplug it.

Contact your nearest Canon service center to request a repair.

B205

Cause

An error requiring a repair has occurred.

What to Do

Turn off the printer and unplug it.

Contact your nearest Canon service center to request a repair.

B206

Cause

An error requiring a repair has occurred.

What to Do

Turn off the printer and unplug it.

Contact your nearest Canon service center to request a repair.

B207

Cause

An error requiring a repair has occurred.

What to Do

Turn off the printer and unplug it.

Contact your nearest Canon service center to request a repair.

B208

Cause

An error requiring a repair has occurred.

What to Do

Turn off the printer and unplug it.

Contact your nearest Canon service center to request a repair.

B209

Cause

An error requiring a repair has occurred.

What to Do

Turn off the printer and unplug it.

Contact your nearest Canon service center to request a repair.

B400

Cause

Printer error has occurred.

What to Do

Turn off the printer and unplug it.

Plug in the printer again and turn it back on.

If this does not solve the problem, contact your nearest Canon service center to request a repair.

B505

Cause

Printer error has occurred.

What to Do

Turn off the printer and unplug it.

Plug in the printer again and turn it back on.

If this does not solve the problem, contact your nearest Canon service center to request a repair.

B506

Cause

Printer error has occurred.

What to Do

Turn off the printer and unplug it.

Plug in the printer again and turn it back on.

If this does not solve the problem, contact your nearest Canon service center to request a repair.

B507

Cause

Printer error has occurred.

What to Do

Check the status of ink tanks. Replace the ink tank if the ink has run out.

Turn off the printer and unplug it.

Plug in the printer again and turn it back on.

If this does not solve the problem, contact your nearest Canon service center to request a repair.

B600

Cause

Printer error has occurred.

What to Do

Turn off the printer and unplug it.

Plug in the printer again and turn it back on.

If this does not solve the problem, contact your nearest Canon service center to request a repair.

B801

Cause

Printer error has occurred.

What to Do

Turn off the printer and unplug it.

Plug in the printer again and turn it back on.

If this does not solve the problem, contact your nearest Canon service center to request a repair.

B802

Cause

Printer error has occurred.

What to Do

Turn off the printer and unplug it.

Plug in the printer again and turn it back on.

If this does not solve the problem, contact your nearest Canon service center to request a repair.